

## Operating Instructions Functional Manual

LCD Projector Commercial Use

Model No.      PT-EZ590  
                         PT-EW650  
                         PT-EW550  
                         PT-EX620  
                         PT-EX520

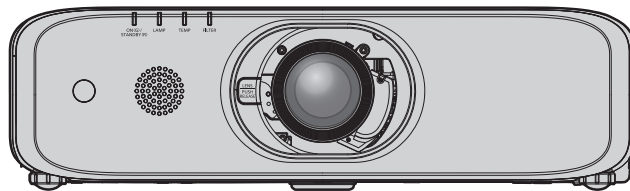

Thank you for purchasing this Panasonic product.

- This manual is intended for products manufactured from Sep. 2018 and beyond.
- This manual is common to all the models regardless of suffixes of the Model No.
  - for Taiwan  
T: The standard zoom lens supplied
  - for India  
D: The standard zoom lens supplied
  - for Asia (except for Taiwan, India, Korea)  
A: The standard zoom lens supplied      LA: The lens sold separately
  - for other countries or regions  
Without L: The standard zoom lens supplied      With L: The lens sold separately
- Before operating this product, please read the instructions carefully and save this manual for future use.
- Before using this product, be sure to read “Read this first!” (➡ pages 4 to 13).



# Contents

<b>Read this first!</b> .....	<b>4</b>	Switching off the projector .....	51
		Direct power off function .....	51
<b>Chapter 1 Preparation</b>		<b>Projecting</b> .....	<b>52</b>
<b>Precautions for use</b> .....	<b>17</b>	Selecting the input signal .....	52
Lens cushion .....	17	Adjusting the focus, zoom and shift .....	53
Cautions when transporting .....	17	Moving the lens to the home position .....	54
Cautions when installing .....	17	Adjustment range by the lens position shift (optical axis shift) .....	54
Security .....	19	<b>Operating with the remote control</b> .....	<b>55</b>
DIGITAL LINK .....	19	Using the shutter/AV mute function .....	55
Notes on Using Wireless Connection .....	20	Using the mute function .....	56
Early Warning Software .....	21	Adjusting the volume .....	56
Cautions on use .....	21	Using the freeze function .....	56
Storage .....	22	Using the on-screen display function .....	56
Disposal .....	22	Using the automatic setup function .....	57
Accessories .....	23	Using the SCREEN ADJ button .....	57
Optional accessories .....	24	Switching the aspect ratio of the image .....	58
<b>About your projector</b> .....	<b>25</b>	Using the digital zoom function .....	58
Remote control .....	25	Using the presentation timer function .....	59
Projector body .....	26	Using the FUNCTION button .....	59
<b>Preparing the remote control</b> .....	<b>29</b>	Displaying internal test patterns .....	59
Inserting and removing the batteries .....	29	Using the status function .....	60
When using the system with multiple projectors ..	29	Using the ECO management function .....	60
Connecting the remote control to the projector with a cable .....	29	Setting the ID number of the remote control .....	61
<b>Chapter 2 Getting Started</b>		<b>Chapter 4 Settings</b>	
<b>Setting up</b> .....	<b>31</b>	<b>Menu navigation</b> .....	<b>63</b>
Installation mode .....	31	Navigating through the menu .....	63
Parts for ceiling mount (optional) .....	31	Main menu .....	64
Projected image and throw distance .....	32	Sub-menu .....	64
Adjusting adjustable feet .....	38	<b>[PICTURE] menu</b> .....	<b>67</b>
<b>Removing/attaching the projection lens</b> .....	<b>39</b>	[PICTURE MODE] .....	67
Removing the projection lens .....	39	[CONTRAST] .....	67
Attaching the projection lens .....	39	[BRIGHTNESS] .....	67
<b>Connecting</b> .....	<b>41</b>	[COLOR] .....	68
Before connecting .....	41	[TINT] .....	68
Connecting example: AV equipment .....	42	[SHARPNESS] .....	68
Connecting example: Computers .....	43	[COLOR TEMPERATURE] .....	68
Connecting example using DIGITAL LINK .....	43	[GAMMA] .....	69
<b>Chapter 3 Basic Operations</b>		[IRIS] .....	69
<b>Switching on/off the projector</b> .....	<b>46</b>	[ADVANCED MENU] .....	69
Connecting the power cord .....	46	[DAYLIGHT VIEW] .....	70
Power indicator .....	46	[DIGITAL CINEMA REALITY] .....	70
Switching on the projector .....	47	[NOISE REDUCTION] .....	70
When the initial setting screen is displayed .....	48	[TV-SYSTEM] .....	71
Making adjustments and selections .....	50	[RGB/YP <sub>B</sub> P <sub>R</sub> ]/[RGB/YC <sub>B</sub> C <sub>R</sub> ] .....	71
		<b>[POSITION] menu</b> .....	<b>72</b>
		[REALTIME KEYSTONE] .....	72
		[SCREEN ADJUSTMENT] (For PT-EZ590) .....	72

## Contents

[SCREEN ADJUSTMENT] (For PT-EW650, PT-EW550, PT-EX620 and PT-EX520).....	76	[MENU LOCK].....	106
[SHIFT].....	78	[MENU LOCK PASSWORD].....	106
[DOT CLOCK].....	78	[CONTROL DEVICE SETUP].....	106
[CLOCK PHASE].....	79	<b>[NETWORK] menu.....</b>	<b>108</b>
[OVER SCAN].....	79	[DIGITAL LINK MODE].....	108
[ASPECT].....	79	[DIGITAL LINK STATUS].....	108
[FRAME LOCK].....	80	[DIGITAL LINK MENU].....	109
[CLAMP POSITION].....	80	[WIRED LAN].....	109
<b>[LANGUAGE] menu.....</b>	<b>81</b>	[PROJECTOR NAME].....	109
Changing the display language.....	81	[NETWORK CONTROL].....	110
<b>[DISPLAY OPTION] menu.....</b>	<b>82</b>	[NETWORK STATUS].....	110
[ON-SCREEN DISPLAY].....	82	[INITIALIZE].....	111
[RGB IN].....	83		
[HDMI IN].....	84	<b>Chapter 5 Operation of Function</b>	
[DIGITAL LINK IN].....	85	<b>Network connections.....</b>	<b>113</b>
[CLOSED CAPTION SETTING] (Only for NTSC, 480i YC <sub>B</sub> C <sub>R</sub> input).....	86	When connecting via wired LAN.....	113
[SCREEN SETTING].....	87	When connecting via wireless LAN.....	115
[STARTUP LOGO].....	88	<b>About Presenter Light.....</b>	<b>117</b>
[SHUTTER SETTING].....	88	<b>About VueMagic.....</b>	<b>119</b>
[AUTO SETUP SETTING].....	89	<b>Web control function.....</b>	<b>120</b>
[SIGNAL SEARCH].....	89	Accessing from the web browser.....	120
[STARTUP INPUT SELECT].....	89		
[BACK COLOR].....	90	<b>Chapter 6 Maintenance</b>	
[WIDE MODE].....	90	<b>Lamp/temperature/filter indicators.....</b>	<b>137</b>
[SXGA MODE].....	90	When an indicator lights up.....	137
[P-TIMER].....	90	<b>Maintenance/replacement.....</b>	<b>139</b>
[OTHER FUNCTIONS].....	91	Before performing maintenance/replacement....	139
<b>[PROJECTOR SETUP] menu.....</b>	<b>93</b>	Maintenance.....	139
[STATUS].....	93	Replacing the unit.....	142
[PROJECTOR ID].....	93	<b>Troubleshooting.....</b>	<b>145</b>
[INITIAL START UP].....	93		
[PROJECTION METHOD].....	94	<b>Chapter 7 Appendix</b>	
[LAMP POWER].....	94	<b>Technical information.....</b>	<b>148</b>
[ECO MANAGEMENT].....	94	PJLink protocol.....	148
[RS-232C].....	96	Control commands via LAN.....	149
[REMOTE1 MODE].....	97	<SERIAL IN> terminal.....	152
[FUNCTION BUTTON].....	97	<REMOTE 1 IN> terminal.....	155
[AUDIO SETTING].....	98	[MENU LOCK PASSWORD] operations.....	156
[TEST PATTERN].....	100	List of compatible signals.....	157
[FILTER COUNTER].....	100	<b>Specifications.....</b>	<b>159</b>
[SCHEDULE].....	101	<b>Dimensions.....</b>	<b>162</b>
[DATE AND TIME].....	103	<b>Precautions for Attaching Ceiling Mount Bracket.....</b>	<b>163</b>
[LENS CALIBRATION].....	103	<b>Index.....</b>	<b>164</b>
[INITIALIZE ALL].....	104		
[SERVICE PASSWORD].....	104		
<b>[SECURITY] menu.....</b>	<b>105</b>		
[PASSWORD].....	105		
[PASSWORD CHANGE].....	105		
[DISPLAY SETTING].....	105		
[TEXT CHANGE].....	106		

# Read this first!

**WARNING:** THIS APPARATUS MUST BE EARTHED.

**WARNING:** To prevent damage which may result in fire or shock hazard, do not expose this appliance to rain or moisture.  
This device is not intended for use in the direct field of view at visual display workplaces. To avoid incommoding reflexions at visual display workplaces this device must not be placed in the direct field of view.  
The equipment is not intended for used at a video workstation in compliance BildscharbV.

The sound pressure level at the operator position is equal or less than 70 dB (A) according to ISO 7779.

**WARNING:**

1. Remove the plug from the mains socket when this unit is not in use for a prolonged period of time.
2. To prevent electric shock, do not remove cover. No user serviceable parts inside. Refer servicing to qualified service personnel.
3. Do not remove the earthing pin on the mains plug. This apparatus is equipped with a three prong earthing-type mains plug. This plug will only fit an earthing-type mains socket. This is a safety feature. If you are unable to insert the plug into the mains socket, contact an electrician. Do not defeat the purpose of the earthing plug.

**WARNING:**

This equipment is compliant with Class A of CISPR32.  
In a residential environment this equipment may cause radio interference.

**WARNING:** TO REDUCE THE RISK OF FIRE OR ELECTRIC SHOCK, DO NOT EXPOSE THIS PRODUCT TO RAIN OR MOISTURE.

**WARNING:** RISK OF ELECTRIC SHOCK. DON'T OPEN



Indicated on the projector



The lightning flash with arrowhead symbol, within an equilateral triangle, is intended to alert the user to the presence of uninsulated “dangerous voltage” within the product’s enclosure that may be of sufficient magnitude to constitute a risk of electric shock to persons.



The exclamation point within an equilateral triangle is intended to alert the user to the presence of important operating and maintenance (servicing) instructions in the literature accompanying the product.

**WARNING:** TURN THE POWER OFF AND DISCONNECT THE POWER PLUG FROM THE WALL OUTLET BEFORE REPLACING THE LAMP UNIT.



**CAUTION:** To assure continued compliance, follow the attached installation instructions. This includes using the provided power cord and shielded interface cables when connecting to computer or peripheral devices. Also, any unauthorized changes or modifications to this equipment could void the user’s authority to operate this device.

This is a device to project images onto a screen, etc., and is not intended for use as indoor lighting in a domestic environment.

Directive 2009/125/EC

**Importer's name and address within the European Union**  
Panasonic Marketing Europe GmbH  
Panasonic Testing Centre  
Winsbergring 11, 22525 Hamburg, Germany

**CAUTION (North/Middle/South America)**

**Power Supply:** This Projector is designed to operate on 100 V - 240 V, 50 Hz/60 Hz AC, house current only.

**CAUTION:** The AC power cord which is supplied with the projector as an accessory can only be used for power supplies up to 125 V. If you need to use higher voltages than this, you will need to obtain a separate 250 V power cord. If you use the accessory cord in such situations, fire may result.

**CAUTION (North/Middle/South America)**

This equipment is equipped with a three-pin grounding-type power plug. Do not remove the grounding pin on the power plug. This plug will only fit a grounding-type power outlet. This is a safety feature. If you are unable to insert the plug into the outlet, contact an electrician. Do not defeat the purpose of the grounding plug.

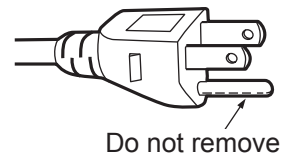

**CAUTION (Taiwan)**

This equipment is equipped with a three-pin grounding-type power plug. Do not remove the grounding pin on the power plug. This plug will only fit a grounding-type power outlet. This is a safety feature. If you are unable to insert the plug into the outlet, contact an electrician. Do not defeat the purpose of the grounding plug.

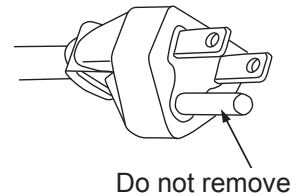

**緊急處理方法**

為防止使用者及其他人之危害及生命財產的損失，如有發生異常時，請立即拔出電源線插頭並停止使用。

**臺灣限定的廢電池回收標識**



廢電池請回收

**WARNING (USA and Canada)**

- Not for use in a computer room as defined in the Standard for the Protection of Electronic Computer/Data Processing Equipment, ANSI/NFPA 75.
- For permanently connected equipment, a readily accessible disconnect device shall be incorporated in the building installation wiring.
- For pluggable equipment, the socket-outlet shall be installed near the equipment and shall be easily accessible.

**NOTICE USA only:**

- This product has a High Intensity Discharge (HID) lamp that contains mercury. Disposal may be regulated in your community due to environmental considerations. For disposal or recycling information, please visit Panasonic website: <http://www.panasonic.com/environmental> or call 1-888-769-0149.

**For USA-California Only**

This product contains a CR Coin Cell Lithium Battery which contains Perchlorate Material – special handling may apply.  
See [www.dtsc.ca.gov/hazardouswaste/perchlorate](http://www.dtsc.ca.gov/hazardouswaste/perchlorate)

## NOTIFICATION (Canada)

This class A digital apparatus complies with Canadian ICES-003.

### Contains mercury/Contenu avec mercure

For more information on safe handling procedures, the measures to be taken in case of accidental breakage and safe disposal options visit:  
[ec.gc.ca/mercure-mercury/](http://ec.gc.ca/mercure-mercury/).  
Dispose of or recycle in accordance with applicable laws.

Pour plus de renseignements sur les procédures de manutention sécuritaire, les mesures à prendre en cas de bris accidentel et les options d'élimination sécuritaire visitez:  
[ec.gc.ca/mercure-mercury/](http://ec.gc.ca/mercure-mercury/).  
Mettez au rebut ou recyclez conformément aux lois applicables.

## FCC NOTICE (USA)

### Verification

Model Number: PT-EZ590 / PT-EZ590L / PT-EW650 / PT-EW650L / PT-EW550 / PT-EW550L / PT-EX620 / PT-EX620L / PT-EX520 / PT-EX520L  
Trade Name: Panasonic  
Responsible Party: Panasonic Corporation of North America  
Address: Two Riverfront Plaza, Newark, NJ 07102-5490  
General Contact: <http://www.panasonic.com/support>  
Projector Contact: <https://panasonic.net/cns/projector/>

This device complies with Part 15 of the FCC Rules. Operation is subject to the following two conditions: (1) This device may not cause harmful interference, and (2) this device must accept any interference received, including interference that may cause undesired operation.

### Caution:

This equipment has been tested and found to comply with the limits for a Class A digital device, pursuant to part 15 of the FCC Rules. These limits are designed to provide reasonable protection against harmful interference when the equipment is operated in a commercial environment. This equipment generates, uses, and can radiate radio frequency energy and, if not installed and used in accordance with the instruction manual, may cause harmful interference to radio communications. Operation of this equipment in a residential area is likely to cause harmful interference in which case the user will be required to correct the interference at his own expense.

### FCC Warning:

To assure continued compliance, follow the attached installation instructions. This includes using the provided power cord and shielded interface cables when connecting to computer or peripheral devices. Also, any unauthorized changes or modifications to this equipment could void the user's authority to operate this device.

## IMPORTANT: THE MOULDED PLUG

FOR YOUR SAFETY, PLEASE READ THE FOLLOWING TEXT CAREFULLY.

This appliance is supplied with a moulded three pin mains plug for your safety and convenience. A 13 amp fuse is fitted in this plug. Should the fuse need to be replaced, please ensure that the replacement fuse has a rating of 13 amps and that it is approved by ASTA or BSI to BS1362.

Check for the ASTA mark  or the BSI mark  on the body of the fuse.

If the plug contains a removable fuse cover, you must ensure that it is refitted when the fuse is replaced. If you lose the fuse cover, the plug must not be used until a replacement cover is obtained. A replacement fuse cover can be purchased from an Authorised Service Center.

**If the fitted moulded plug is unsuitable for the mains socket in your home, then the fuse should be removed and the plug cut off and disposed of safely. There is a danger of severe electrical shock if the cut off plug is inserted into any 13 amp socket.**

If a new plug is to be fitted, please observe the wiring code as shown below.  
If in any doubt, please consult a qualified electrician.

**WARNING:** THIS APPLIANCE MUST BE EARTHED.

**IMPORTANT:** The wires in this mains lead are coloured in accordance with the following code:

Green - and - Yellow: Earth  
Blue: Neutral  
Brown: Live

As the colours of the wire in the mains lead of this appliance may not correspond with the coloured markings identifying the terminals in your plug, proceed as follows.

The wire which is coloured GREEN - AND - YELLOW must be connected to the terminal in the plug which is marked with the letter E or by the Earth symbol  or coloured GREEN or GREEN - AND - YELLOW.

The wire which is coloured BLUE must be connected to the terminal in the plug which is marked with the letter N or coloured BLACK.

The wire which is coloured BROWN must be connected to the terminal in the plug which is marked with the letter L or coloured RED.

How to replace the fuse: Open the fuse compartment with a screwdriver and replace the fuse.

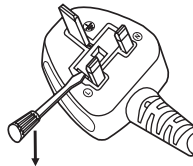

## To remove the battery

### Remote Control Battery

1. Press the guide and lift the cover.

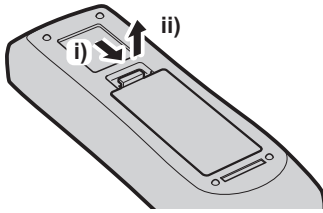

2. Remove the batteries.

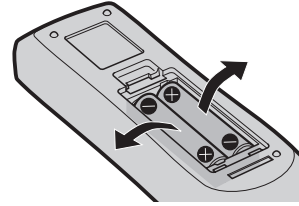

## Brazil Only

### Brasil Apenas

#### ■ Manuseio de baterias usadas



#### **BRASIL**

Após o uso, as pilhas e/ou baterias deverão ser entregues ao estabelecimento comercial ou rede de assistência técnica autorizada.

Cobrir os terminais positivo (+) e negativo (-) com uma fita isolante adesiva, antes de depositar numa caixa destinada para o recolhimento. O contato entre partes metálicas pode causar vazamentos, gerar calor, romper a blindagem e produzir fogo. (Fig. 1)

Fig. 1

Como isolar os terminais

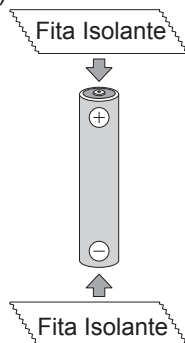

Não desmonte, não remova o invólucro, nem amasse a bateria. O gás liberado pela bateria pode irritar a garganta, danificar o lacre do invólucro ou o vazamento provocar calor, ruptura da blindagem e produzir fogo devido ao curto circuito dos terminais. Não incinere nem aqueça as baterias, elas não podem ficar expostas a temperaturas superiores a 100 °C (212 °F). O gás liberado pela bateria pode irritar a garganta, danificar o lacre do invólucro ou o vazamento provocar calor, ruptura da blindagem e produzir fogo devido ao curto circuito dos terminais provocado internamente.

Evite o contato com o líquido que vazar das baterias. Caso isto ocorra, lave bem a parte afetada com bastante água. Caso haja irritação, consulte um médico.

#### ■ Remoção das baterias

1. Pressione a guia e levante a tampa.

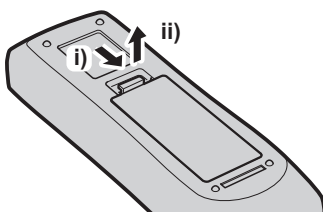

2. Remova as baterias.

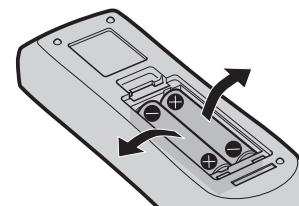



## **WARNING:**

### **■ POWER**

**The wall outlet or the circuit breaker shall be installed near the equipment and shall be easily accessible when problems occur. If the following problems occur, cut off the power supply immediately.**

Continued use of the projector in these conditions will result in fire or electric shock.

- If foreign objects or water get inside the projector, cut off the power supply.
- If the projector is dropped or the cabinet is broken, cut off the power supply.
- If you notice smoke, strange smells or noise coming from the projector, cut off the power supply.

Please contact an Authorized Service Center for repairs, and do not attempt to repair the projector yourself.

**During a thunderstorm, do not touch the projector or the cable.**

Electric shocks can result.

**Do not do anything that might damage the power cord or the power plug.**

If the power cord is used while damaged, electric shocks, short-circuits or fire will result.

- Do not damage the power cord, make any modifications to it, place it near any hot objects, bend it excessively, twist it, pull it, place heavy objects on top of it or wrap it into a bundle.

Ask an Authorized Service Center to carry out any repairs to the power cord that might be necessary.

**Completely insert the power plug into the wall outlet and the power connector into the projector terminal.**

If the plug is not inserted correctly, electric shocks or overheating will result.

- Do not use plugs which are damaged or wall outlets which are coming loose from the wall.

**Do not use anything other than the provided power cord.**

Failure to observe this will result in electric shocks or fire. Please note that if you do not use the provided power cord to ground the device on the side of the outlet, this may result in electric shocks.

**Clean the power plug regularly to prevent it from becoming covered in dust.**

Failure to observe this will cause a fire.

- If dust builds up on the power plug, the resulting humidity can damage the insulation.
- If not using the projector for an extended period of time, pull the power plug out from the wall outlet.

Pull the power plug out from the wall outlet and wipe it with a dry cloth regularly.

**Do not handle the power plug and power connector with wet hands.**

Failure to observe this will result in electric shocks.

**Do not overload the wall outlet.**

If the power supply is overloaded (ex., by using too many adapters), overheating may occur and fire will result.

### **■ ON USE/INSTALLATION**

**Do not place the projector on soft materials such as carpets or sponge mats.**

Doing so will cause the projector to overheat, which can cause burns, fire or damage to the projector.

**Do not set up the projector in humid or dusty places or in places where the projector may come into contact with oily smoke or steam.**

Using the projector under such conditions will result in fire, electric shocks or deterioration of components.

Deterioration of components (such as ceiling mount brackets) may cause the projector which is mounted on the ceiling to fall down.

**Do not install this projector in a place which is not strong enough to take the full weight of the projector or on top of a surface which is sloped or unstable.**

Failure to observe this will cause projector to fall down or tip over the projector, and severe injury or damage could result.

## **WARNING:**

### **Do not cover the air intake/exhaust ports.**

Doing so will cause the projector to overheat, which can cause fire or damage to the projector.

- Do not place the projector in narrow, badly ventilated places.
- Do not place the projector on cloth or papers, as these materials could be drawn into the air intake port.
- Provide at least 1 m (40") of space between any walls or objects and the exhaust port, and at least 50 cm (20") of space between any walls or objects and the intake port.

### **Do not place your hands or other objects close to the air exhaust port.**

Doing so will cause burns or damage your hands or other objects.

- Heated air comes out of the air exhaust port. Do not place your hands or face, or objects which cannot withstand heat close to this port.

### **Do not look at or place your skin into the light emitted from the lens while the projector is being used.**

Doing so can cause burns or loss of sight.

- Strong light is emitted from the projector's lens. Do not look at or place your hands directly into this light.
- Be especially careful not to let young children look into the lens. In addition, turn off the power and switch off the main power when you are away from the projector.

### **Never attempt to remodel or disassemble the projector.**

High voltages can cause fire or electric shocks.

- For any inspection, adjustment and repair work, please contact an Authorized Service Center.

### **Do not project an image with the lens cover attached.**

Doing so can cause fire.

### **Do not allow metal objects, flammable objects, or liquids to enter inside of the projector. Do not allow the projector to get wet.**

Doing so may cause short circuits or overheating, and result in fire, electric shock, or malfunction of the projector.

- Do not place containers of liquid or metal objects near the projector.
- If liquid enters inside of the projector, consult your dealer.
- Particular attention must be paid to children.

### **Use the ceiling mount bracket specified by Panasonic.**

Using the ceiling mount bracket other than the specified one will result in falling accidents.

- Attach the supplied safety cable to the ceiling mount bracket to prevent the projector from falling down.

### **Installation work (such as ceiling mount bracket) should only be carried out by a qualified technician.**

If installation is not carried out and secured correctly, it can cause injury or accidents, such as electric shocks.

- Be sure to use the wire provided with the ceiling mount bracket as an extra safety measure to prevent the projector from falling down. (Install in a different location to the ceiling mount bracket.)

## **■ ACCESSORIES**

### **Do not use or handle the batteries improperly, and refer to the following.**

Failure to observe this will cause burns, batteries to leak, overheat, explode or catch fire.

- Do not use unspecified batteries.
- Do not use chargeable batteries.
- Do not disassemble dry cell batteries.
- Do not heat the batteries or place them into water or fire.
- Do not allow the + and – terminals of the batteries to come into contact with metallic objects such as necklaces or hairpins.
- Do not store or carry batteries together with metallic objects.
- Store the batteries in a plastic bag and keep them away from metallic objects.
- Make sure the polarities (+ and –) are correct when inserting the batteries.
- Do not use a new battery together with an old battery or mix different types of batteries.
- Do not use batteries with the outer cover peeling away or removed.

**WARNING:**

**If the battery fluid leaks, do not touch it with bare hands, and take the following measures if necessary.**

- Battery fluid on your skin or clothing could result in skin inflammation or injury.  
Rinse with clean water and seek medical advice immediately.
- Battery fluid coming in contact with your eyes could result in loss of sight.  
In this case, do not rub your eyes. Rinse with clean water and seek medical advice immediately.

**Do not remove unspecified screws during the lamp unit replacement.**

Doing so can cause electric shocks, burns, or injury.

**Do not disassemble the lamp unit.**

If the lamp breaks, it could cause injury.

**Lamp replacement**

The lamp has high internal pressure. If improperly handled, an explosion and severe injury or accidents will result.

- The lamp can easily explode if struck against hard objects or dropped.
- Before replacing the lamp unit, be sure to turn the power off and to disconnect the power plug from the wall outlet.  
Electric shocks or explosions can result if this is not done.
- When replacing the lamp unit, turn the power off and allow the lamp to cool for at least one hour before handling it otherwise it can cause burns.

**Do not use the supplied power cord with devices other than this projector.**

- Using the supplied power cord with devices other than this projector may cause short circuits or overheating, and result in electric shock or fire.

**Do not allow children to reach the batteries and the lens release button fixing screw.**

Accidentally swallowing them can cause physical harm.

- If swallowed, seek medical advice immediately.

**Remove the depleted batteries from the remote control promptly.**

- Leaving them in the unit may result in fluid leakage, overheating, or explosion of the batteries.

## CAUTION:

### ■ POWER

**When disconnecting the power cord, be sure to hold the power plug and the power connector.**

If the power cord itself is pulled, the lead will become damaged, and fire, short-circuits or serious electric shocks will result.

**When not using the projector for an extended period of time, disconnect the power plug from the wall outlet.**

Failure to do so may result in fire or electric shock.

**Before replacing the projection lens, be sure to turn off the power and disconnect the power plug from the wall outlet.**

- Unexpected projection of light may cause injury to eyes.
- Replacing the projection lens without removing the power plug may result in electric shock.

**Disconnect the power plug from the wall outlet before carrying out any cleaning and replacing the unit.**

Failure to do so may result in electric shock.

### ■ ON USE/INSTALLATION

**Do not place heavy objects on top of the projector.**

Failure to observe this will cause the projector to become unbalanced and fall, which could result in damage or injury. The projector will be damaged or deformed.

**Do not put your weight on this projector.**

You could fall or the projector could break, and injury will result.

- Be especially careful not to let young children stand or sit on the projector.

**Do not place the projector in extremely hot locations.**

Doing so will cause the outer casing or internal components to deteriorate, or result in fire.

- Take particular care in locations exposed to direct sunlight or near heaters.

**Do not install the projector in a location where salt pollution or corrosive gas may occur.**

Doing so may result in falling due to corrosion. Also, it may result in malfunctions.

**Do not place your hands in the openings beside the optical lens, while shifting the lens.**

Failure to observe this could cause injury.

**Do not place objects in front of the lens while the projector is being used.**

Doing so can cause fire, damage to an object, or malfunction of the projector.

- Extremely strong light is emitted from the projector's lens.

**Do not stand in front of the lens while the projector is being used.**

Doing so can cause damage and burns to clothing.

- Extremely strong light is emitted from the projector's lens.

**Always disconnect all cables before moving the projector.**

Moving the projector with cables still attached can damage the cables, which will cause fire or electric shocks to occur.

**When mounting the projector on the ceiling, keep mounting screws and power cord from contact with metal parts inside the ceiling.**

Contact with metal parts inside the ceiling can cause electric shocks.

**Never plug headphones and earphones into <VARIABLE AUDIO OUT> terminal.**

Excessive sound pressure from earphones and headphones can cause hearing loss.

### ■ ACCESSORIES

**Do not use the old lamp unit.**

If used it could cause lamp explosion.

**If the lamp has broken, ventilate the room immediately. Do not touch or bring your face close to the broken pieces.**

Failure to observe this will cause the user to absorb the gas which was released when the lamp broke and which contains nearly the same amount of mercury as fluorescent lamps, and the broken pieces will cause injury.

- If you believe that you have absorbed the gas or that the gas has got into your eyes or mouth, seek medical advice immediately.
- Ask your dealer about replacing the lamp unit and check the inside of the projector.

**CAUTION:**

**When not using the projector for an extended period of time, remove the batteries from the remote control.**

Failure to observe this will cause the batteries to leak, overheat, catch fire or explode, which may result in fire or contamination of surrounding area.

■ **MAINTENANCE**

**Do not attach the air filter unit while it is wet.**

Doing so may result in electric shock or malfunctions.

- After you clean the air filter units, dry them thoroughly before reattaching them.

**Ask your dealer about cleaning inside the projector once a year.**

Continuous use while dust is accumulated inside the projector may result in fire.

- For cleaning fee, ask your dealer.

---

## ■ Trademarks

- Windows, Internet Explorer and Microsoft Edge are registered trademarks or trademarks of Microsoft Corporation in the United States and other countries.
- Mac, Mac OS, OS X, iPad, iPhone, iPod touch and Safari are trademarks of Apple Inc., registered in the United States and other countries.
- IOS is a trademark and registered trademark of Cisco in the United States and other countries and is used under license.
- Android is a trademark of Google Inc.
- VueMagic is a trademark of Pixelworks, Inc.
- PJLink™ is a registered trademark or pending trademark in Japan, the United States and other countries and regions.
- The terms HDMI and HDMI High-Definition Multimedia Interface, and the HDMI Logo are trademarks or registered trademarks of HDMI Licensing Administrator, Inc. in the United States and other countries.
- RoomView and Crestron RoomView are registered trademarks of Crestron Electronics, Inc. Crestron Connected™ and Fusion RV are trademarks of Crestron Electronics, Inc.
- HDBaseT™ is a trademark of HDBaseT Alliance.
- Adobe, Adobe Flash Player and Adobe Reader are trademarks or registered trademarks of Adobe Systems Inc. in the United States and/or other countries.
- Some of the fonts used in the on-screen menu are Ricoh bitmap fonts, which are manufactured and sold by Ricoh Company, Ltd.
- All other names, company names and product names mentioned in this manual are trademarks or registered trademarks of their respective owners.  
Please note that the ® and ™ symbols are not specified in this manual.

## ■ Software information regarding this product

This product incorporates the following software:

- (1) the software developed independently by or for Panasonic Corporation,
- (2) the software owned by third party and licensed to Panasonic Corporation,
- (3) the software licensed under the GNU General Public License, Version 2.0 (GPL V2.0),
- (4) the software licensed under the GNU LESSER General Public License, Version 2.1 (LGPL V2.1), and/or
- (5) open source software other than the software licensed under the GPL V2.0 and/or LGPL V2.1.

The software categorized as (3) - (5) are distributed in the hope that it will be useful, but WITHOUT ANY WARRANTY, without even the implied warranty of MERCHANTABILITY or FITNESS FOR A PARTICULAR PURPOSE. Please refer to the detailed terms and conditions thereof shown in the attached CD-ROM.

At least three (3) years from delivery of this product, Panasonic will give to any third party who contacts us at the contact information provided below, for a charge no more than our cost of physically performing source code distribution, a complete machine-readable copy of the corresponding source code covered under GPL V2.0, LGPL V2.1 or the other licenses with the obligation to do so, as well as the respective copyright notice thereof.

Contact Information: [oss-cd-request@gg.jp.panasonic.com](mailto:oss-cd-request@gg.jp.panasonic.com)

## ■ Illustrations in this manual

- Illustrations of the projector, screen, and other parts may vary from the actual product.
- Pictures shown are illustrations of PT-EZ590 in this manual, other models have their own characteristics and may be different from them.

## ■ Reference pages

- Reference pages in this manual are indicated as (➡ page 00).

## ■ Term

- In this manual, the “Wireless/wired remote control unit” accessory is referred to as “Remote control”.

## Features of the Projector

### High luminance and high contrast<sup>\*2</sup>

- ▶ A high luminance<sup>\*1</sup> and a high contrast<sup>\*2</sup> (Except for PT-EW550, PT-EX520) are achieved by means of a unique optical system and lamp drive system.

<sup>\*1</sup> PT-EX620 is 6 200 lm, PT-EW650 is 5 800 lm, PT-EZ590 is 5 400 lm, PT-EX520 is 5 300 lm and PT-EW550 is 5 000 lm.

<sup>\*2</sup> PT-EZ590, PT-EW650 and PT-EX620 are 10 000:1, PT-EW550 and PT-EX520 are 2 000:1.

### Easy and highly flexible setup

- ▶ Easy and highly flexible setup is achieved by an electric lens shift function, and a lineup of various optional lenses.
- ▶ KEYSTONE, CORNER CORRECTION and CURVED CORRECTION functions allow you to correct the distortion of the various images easily.

### Reduced maintenance costs

- ▶ New lamp driving system and long life filter have greatly improved the recommended time to replace the lamp and filter, so you can reduce the maintenance cost.

[Reference]

- Lamp: 4 000 Hours ([LAMP POWER] is set to [NORMAL])  
5 000 Hours ([LAMP POWER] is set to [ECO])
- Filter: 15 000 Hours

\* This time is only the target for replacement and not the warranty time.

## Quick Steps

For details, refer to the corresponding pages.

1. Set up the projector.  
(⇒ page 31)



2. Attach the projection lens.  
(⇒ page 39)



3. Connect with external devices.  
(⇒ page 41)



4. Connect the power cord.  
(⇒ page 46)



5. Switch on the projector.  
(⇒ page 47)



6. Make initial settings.  
(⇒ page 48)

- Take this step when you switch on the power for the first time after purchasing the projector.



7. Select the input signal.  
(⇒ page 52)



8. Adjust the image.  
(⇒ page 53)

# Chapter 1 Preparation

---

This chapter describes things you need to know or check before using the projector.



# Precautions for use

## Lens cushion

(Only for the projector purchased with the standard zoom lens)

- In order to protect the projection lens from the vibration during transportation, lens cushion is attached to the product at the time of purchase. Please remove the lens cushion before use.

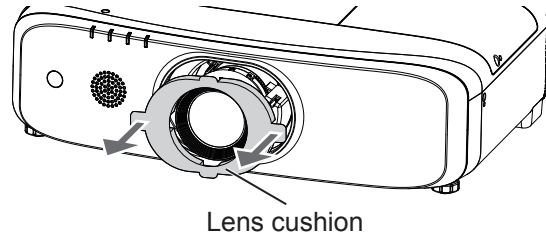

## Cautions when transporting

- When transporting the projector, hold it securely by its bottom and avoid excessive vibration and impacts. They may damage the internal components and result in malfunctions.
- Do not transport the projector with the adjustable feet extended. Doing so may damage the adjustable feet.
- Do not move or transport the projector with the wireless module (Model No.: ET-WML100) of the optional accessories attached. Doing so may damage the wireless module.

## Cautions when installing

### ■ Do not set up the projector outdoors.

The projector is designed for indoor use only.

### ■ Do not set up the projector in the following locations.

- Places where vibration and impacts occur such as in a car or vehicle: Doing so may cause damage to internal components or malfunction.
- Locations near the sea or areas affected by corrosive gas: Corrosion may damage internal components or cause the projector to malfunction.
- Near the exhaust of an air conditioner: Depending on the conditions of use, the screen may fluctuate in rare cases due to the heated air from the air exhaust port or the hot or cooled air. Make sure that the exhaust from the projector or other equipment, or the air from the air conditioner does not blow toward the front of the projector.
- Near high-voltage power lines or near motors: Doing so may interfere with the operation of the projector.
- Places with sharp temperature fluctuations such as near lights (studio lamps): Doing so may shorten the life of the lamp, or result in deformation of the outer case due to heat, which may cause malfunctions. Follow the operating environment temperature of the projector.

### ■ Be sure to ask a specialized technician or your dealer when installing the projector on a ceiling.

The optional Ceiling Mount Bracket is required. Be sure to use the Projector Mount Bracket together with the ceiling mount bracket for high ceilings or low ceilings.

Model No.:

- ① ET-PKD120H (for High Ceilings), ET-PKE301B (Projector Mount Bracket)
- ② ET-PKD120S (for Low Ceilings), ET-PKE301B (Projector Mount Bracket)

### ■ Ask a qualified technician or your dealer to install the cable wiring for DIGITAL LINK connection.

(Only for PT-EZ590, PT-EW650 and PT-EX620)

Image and sound may be disrupted if cable transmission characteristics cannot be obtained due to inadequate installation.

## ■ The projector may not work properly due to strong radio waves from the broadcast station or the radio.

(Only for PT-EZ590, PT-EW650 and PT-EX620)

If there is any facility or equipment, which outputs strong radio waves, near the installation location, install the projector at a location sufficiently far from the source of the radio waves. Or, wrap the LAN cable connected to the <DIGITAL LINK/LAN> terminal by using a piece of metal foil or a metal pipe which is grounded at both ends.

## ■ Focus adjustment

The projection lens is thermally affected by the light from the light source, making the focus unstable in the period just after switching on the power. It is recommended that images be projected continuously for at least 30 minutes before the focus is adjusted.

## ■ Do not install the projector at elevations of 2 700 m (8 858') or higher above sea level.

## ■ Do not use the projector in a location that the ambient temperature exceeds 45 °C (113 °F).

Using the projector in a location that the altitude is too high or the ambient temperature is too high may reduce the life of the components or result in malfunctions.

The upper limit of the operating environment temperature should be between 0 °C (32 °F) and 45 °C (113 °F) when using it at elevations lower than 1 400 m (4 593') above sea level, and between 0 °C (32 °F) and 40 °C (104 °F) when using it at high altitudes (between 1 400 m (4 593') and 2 700 m (8 858') above sea level).

## ■ Do not use the projector tilted to the right or left.

Using the projector at an angle that exceeds  $\pm 15^\circ$  from the horizontal plane may reduce product life or result in malfunction.

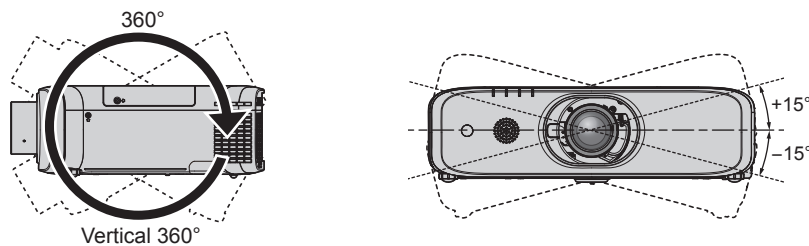

## ■ Cautions when setting up the projector

- Use the adjustable feet only for the floor standing installation and for adjusting the angle. Using them for other purposes may damage the projector.
- When installing and using the projector with a method other than the floor standing installation using the adjustable feet or the ceiling mount, please fix the projector by using the four screw holes with “M6” mark for ceiling mount (as shown in the figure).

(Screw diameter: M6, tapping depth inside the set: 12 mm (15/32"), torque:  $4 \pm 0.5 \text{ N}\cdot\text{m}$ )

Also at that time, make sure that there is no clearance between the screw holes for ceiling mount on the projector bottom and the setting surface by inserting spacers (metallic) between them.

When using the existing ceiling mount bracket (for high ceilings) ET-PKF110H or the existing ceiling mount bracket (for low ceilings) ET-PKF110S, you can use the four screw holes with “M4” mark (as shown in the figure), but do not use these holes for other than ceiling mount. (➔ page 163)

(Screw diameter: M4, tapping depth inside the set: 8 mm (5/16"), torque:  $1.25 \pm 0.2 \text{ N}\cdot\text{m}$ )

In addition, do not mix the M4 and M6 screw holes for installation.

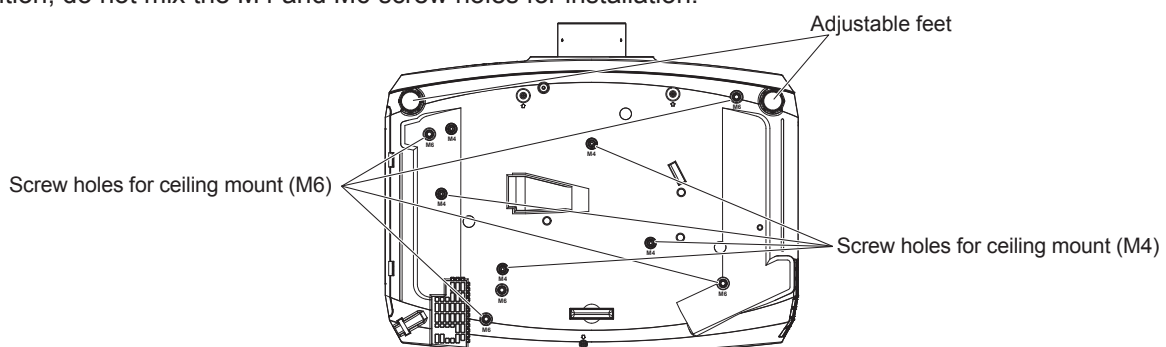

The positions of screw holes for ceiling mount and adjustable feet

- Do not stack projectors on top of each other.
- Do not use the projector supporting it by the top.
- Do not block the ventilation ports (intake and exhaust) of the projector.
- Prevent hot and cool air from the air conditioning system to blow directly to the ventilation ports (intake and exhaust) of the projector.

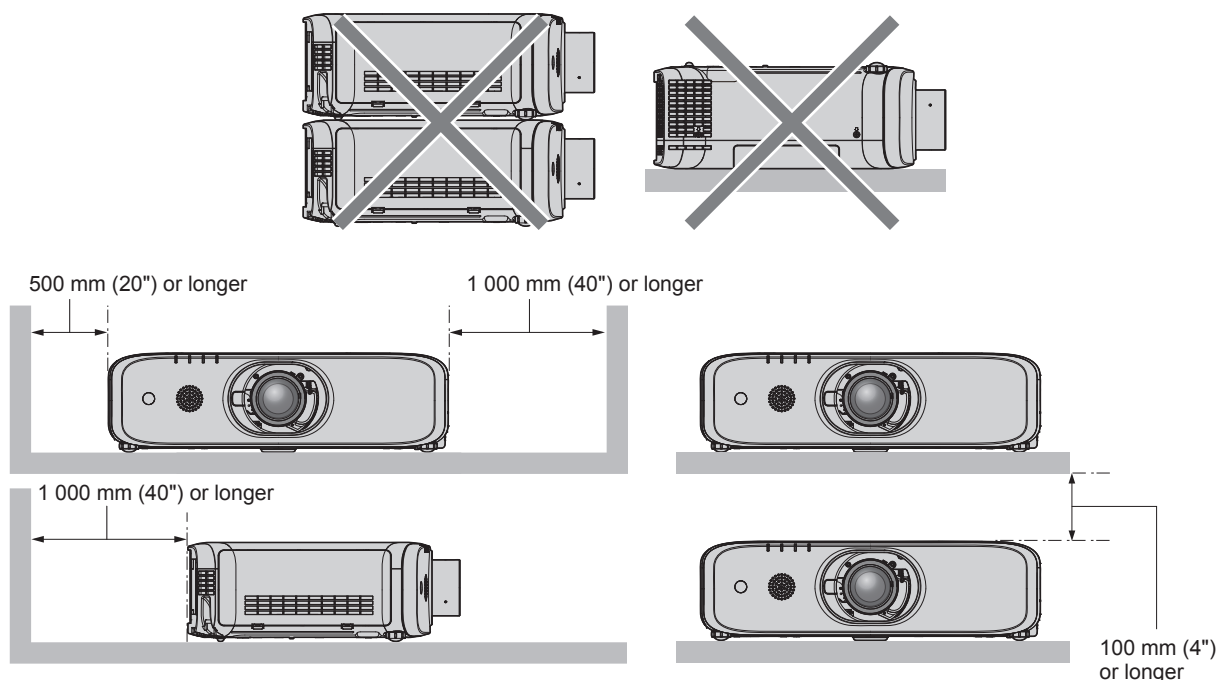

- Do not install the projector in a confined space.  
When installing the projector in a confined space, provide air conditioning or ventilation separately. Exhaust heat may accumulate when the ventilation is not enough, triggering the protection circuit of the projector.

## Security

When using this product, take safety measures against the following incidents.

- Personal information being leaked via this product
  - Unauthorized operation of this product by a malicious third party
  - Interfering or stopping of this product by a malicious third party
- Take sufficient security measures. (➔ pages 105, 132)
- Make your password difficult to guess as much as possible.
  - Change your password periodically. The password can be set in [SECURITY] menu → [PASSWORD CHANGE].
  - Panasonic Corporation or its affiliate companies will never ask for your password directly. Do not divulge your password in case you receive such inquiries.
  - The connecting network must be secured by a firewall, etc.
  - Set a password for the web control and restrict the users who can log in. The password for the web control can be set in [Change password] page of the web control function.

## DIGITAL LINK

(Only for PT-EZ590, PT-EW650 and PT-EX620)

“DIGITAL LINK” is a technology to transmit the video, audio, Ethernet, and serial control signals using a twisted pair cable by adding unique functions by Panasonic to the HDBaseT™ communication standard formulated by HDBaseT Alliance.

This projector supports the optional Panasonic DIGITAL LINK output supported device (Model No.: ET-YFB100G, ET-YFB200G) and peripheral devices by other manufacturers (twisted-pair-cable transmitters such as the “XTP transmitter” of Extron Electronics) that use the same HDBaseT™ standard. For the devices of other manufacturers that the operation has been verified with this projector, refer to Panasonic website (<https://panasonic.net/cns/projector/>). Note that the verification for devices of other manufacturers has been made for the items set by Panasonic Corporation, and not all the operations have been verified. For operation or performance problems caused by the devices of other manufacturers, contact the respective manufacturers.

## Notes on Using Wireless Connection

Wireless connection function of the projector uses radio waves in the 2.4 GHz band.

A radio station license is not required, but be sure to read and fully understand the following items before use.

The wireless module (Model No.: ET-WML100) of optional accessories must be installed when you want to use the wireless LAN function of this projector.

### ■ Do not use near other wireless equipment.

The following equipment may use radio waves in the same band as the projector.

When the projector is used near these devices, radio wave interference may make communication impossible, or the communication speed may become slower.

- Microwave ovens, etc.
- Industrial, chemical and medical equipment, etc.
- In-plant radio stations for identifying moving objects such as those used in factory manufacturing lines, etc.
- Designated low-power radio stations.

### ■ If at all possible, avoid the use of cellular phones, TV sets or radios near the projector.

Cellular phones, TV sets, radios and similar devices use different radio bands from the projector, so there is no effect on wireless communication or the transmission and reception of these devices. However, radio waves from the projector may produce audio or video noise.

### ■ Wireless communication radio waves cannot penetrate steel reinforcements, metal, concrete, etc.

Communication is possible through walls and floors made from materials such as wood and glass (except glass containing wire mesh), but not through walls and floors made from steel reinforcements, metal, concrete, etc.

### ■ Avoid using the projector in locations prone to static electricity.

If the projector is used in a location prone to static electricity, such as on a carpet, the wireless LAN or wired LAN connection may be lost.

If the static electricity or noise make it impossible to establish a connection with the LAN, please press the power button on the remote control or the control panel to power off the projector, and eliminate the source of static electricity or noise, then turn on the projector.

### ■ Using the projector outside the country

Note that depending on countries or regions there are restrictions on the channels and frequencies at which you can use the wireless LAN.

### ■ Available wireless LAN channels

The channels (frequency range) that can be used differ according to the country or region. Refer to the table below.

Country or region	Standard	Channels used	Frequency band (Center frequency)
Global	IEEE802.11b/g/n	1 - 11 channel	2.412 GHz - 2.462 GHz

\*The frequency and channel differ depending on the country.

\*Please use the wireless LAN feature in compliance with the laws of each country.

#### Note

- The wireless module (Model No.: ET-WML100) of the optional accessories is required if you want to use the wireless LAN function of this projector.

### About Wireless LANs

The advantage of a wireless LAN is that information can be exchanged between a PC or other such equipment and an access point using radio waves as long as you are within range for radio transmissions.

On the other hand, because the radio waves can travel through obstacles (such as walls) and are available everywhere within a given range, problems of the type listed below may occur if security-related settings are not made.

- A malicious third-party may intentionally intercept and monitor transmitted data including the content of e-mail and personal information such as your ID, password, and/or credit card numbers.
- A malicious third-party may access your personal or corporate network without authorization and engage in the following types of behavior.
  - Retrieve personal and/or secret information (information leak)
  - Spread false information by impersonating a particular person (spoofing)
  - Overwrite intercepted communications and issue false data (tampering)
  - Spread harmful software such as a computer virus and crash your data and/or system (system crash)

Since most wireless LAN adapters or access points are equipped with security features to take care of these problems, you can reduce the possibility of these problems occurring when using this product by making the appropriate security settings for the wireless LAN device.

Some wireless LAN devices may not be set for security immediately after purchase. To decrease the possibility of occurrence of security problems, before using any wireless LAN devices, be absolutely sure to make all security-related settings according to the instructions given in the operation manuals supplied with them.

Depending on the specifications of the wireless LAN, a malicious third-party may be able to break security settings by special means.

Panasonic asks customers to thoroughly understand the risk of using this product without making security settings, and recommends that the customer make security settings at their own discretion and responsibility.

## Early Warning Software

The projector supports “Early Warning Software”, which monitors the status of the display (projector and flat panel display) and the peripheral devices inside an intranet, and notifies of abnormality of such equipment and detects signs of possible abnormality. Also, maintenance can be performed in advance, because this software gives notification of approximate time to replace consumables of the display, to clean each part of the display, and to replace the components of the display.

Depending on the type of license, the number of displays that can be registered for monitoring varies. Limited to the first 90 days after installation in a computer, it is possible to register up to 2048 units of displays free of charge. Download the software from Panasonic website (<https://panasonic.net/cns/projector/pass/>). It is necessary to register and login to PASS<sup>\*1</sup> to download.

\*1 PASS: Panasonic Professional Display and Projector Technical Support Website

Refer to Panasonic website (<https://panasonic.net/cns/projector/pass/>) for details.

## Cautions on use

### ■ To get a good picture quality

- In order to view a beautiful image in higher contrast, prepare an appropriate environment. Draw curtains or blinds over windows and turn off any lights near the screen to prevent outside light or light from indoor lamps from shining onto the screen.

### ■ Do not touch the surface of the projection lens with your bare hands.

If the surface of the projection lens becomes dirty from fingerprints or anything else, this will be magnified and projected onto the screen.

Attach the lens cover supplied with the projector or with the optional projection lens to the projector when you do not use the projector.

### ■ LCD panel

- The LCD panel is precision-made. Note that in rare cases, pixels of high precision could be missing or always lit. Note that such phenomena do not indicate malfunction. If still images are projected for a long time, a residual image may remain on the LCD panel. Note that the residual image may not disappear.

### ■ Optical parts

When the operating environment temperature is high or in environments where lots of dust, cigarette smoke, etc. is present, the replacement cycle of the LCD panel, polarizing plates and other optical parts may be shorter even if used for less than one year. Consult your dealer for details.

### ■ Do not move the projector or subject it to vibration or impact while it is operating.

Doing so may shorten the life of the built-in motor.

### ■ Lamp

The light source of the projector is a high-pressure mercury lamp.

A high-pressure mercury lamp has the following characteristics.

- The luminance of the lamp will decrease by duration of usage.
- The lamp may burst with a loud sound or have its service life shortened because of shock, chipping, or degradation due to cumulative runtime.
- The lamp life varies greatly depending on individual differences and usage conditions. In particular, continuous use for 12 hours or more and frequent off/on switching of the power greatly deteriorate the lamp and affects the lamp life.
- In rare cases, the lamp bursts shortly after projection starts.
- The risk of bursting increases when the lamp is used beyond its replacement cycle. Make sure to replace the lamp unit regularly.  
(“When to replace the lamp unit” (➔ page 142), “How to replace the lamp unit” (➔ page 143))
- If the lamp bursts, gas contained inside of the lamp is released in the form of smoke.
- It is recommended that you store the Replacement lamp unit as a contingency.

### ■ Computer and external device connections

When connecting a computer or an external device, read this manual carefully regarding the use of power cords and shielded cables as well.

### Storage

---

When storing the projector, keep it in a dry room.

### Disposal

---

To dispose of the product, ask your local authorities or dealer for correct methods of disposal.

The lamp contains mercury. When disposing of used lamp units, contact your local authorities or dealer for correct methods of disposal.

## Accessories

Make sure that the following accessories are provided with your projector. Numbers enclosed in < > show the number of accessories.

### Wireless/wired remote control unit <1>

(N2QAYA000119)

For PT-EZ590, PT-EW650  
and PT-EX620



(N2QAYA000121)

For PT-EW550  
and PT-EX520



### Lens cover <1>

(Only models with lens)

(TXFKK01XMQZ)

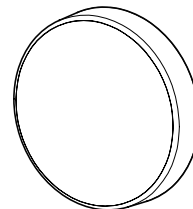

### Power cord

(TXFSX01RXQZ)

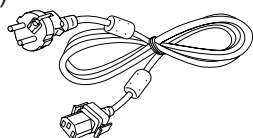

(TXFSX01RWDZ)

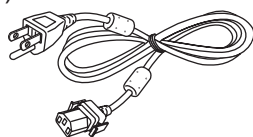

(TXFSX02UTRZ)

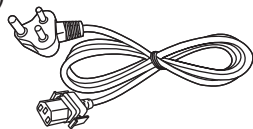

(TXFSX01RXRZ)

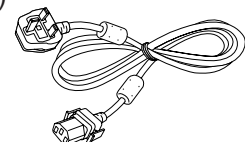

(TXFMX011WET)

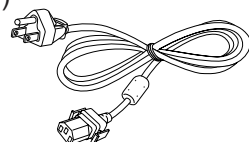

### CD-ROM <1>

(TXFQB02XMQZ)



### AAA/R03 or AAA/LR03 battery <2>

(For remote control unit)

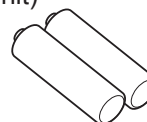

### Lens release button fixing screw <1>

(XSB3+20FN)



## Attention

- After unpacking the projector, discard the power cord cap and packaging material properly.
- Do not use the supplied power cord for devices other than this projector.
- For missing accessories, consult your dealer.
- Store small parts in an appropriate manner, and keep them away from small children.

## Note

- The type and number of the supplied power cords vary depending on the country or region where you purchased the product.
- The model numbers of accessories are subject to change without prior notice.

## Contents of the supplied CD-ROM

The contents of the supplied CD-ROM are as follows.

<b>Instruction/list (PDF)</b>	Operating Instructions	
	Multi Monitoring & Control Software Operating Instructions	
	Logo Transfer Software Operating Instructions	
	Presenter Light Software Operating Instructions	
	List of Compatible Device Models	This is a list of display models (projector or flat panel display) that are compatible with the software contained in the CD-ROM and their restrictions.
Software license	The open source software licenses that used in this projector are included in the PDF files.	
<b>Software</b>	Multi Monitoring & Control Software (Windows)	This software allows you to monitor and control multiple displays (projector or flat panel display) connected to the LAN.
	Logo Transfer Software (Windows)	This software allows you to transfer original images, such as company logos to be displayed when projection starts, to the projector.

## Optional accessories

Optional accessories (product name)	Model No.
Zoom Lens	ET-ELT30, ET-ELT31, ET-ELW30, ET-ELW31
Ceiling Mount Bracket	ET-PKD120H (for High Ceilings) ET-PKD120S (for Low Ceilings) ET-PKE301B (Projector Mount Bracket)
Replacement Lamp Unit	ET-LAEF100
Replacement Filter Unit	ET-RFE300
Early Warning Software (Basic license/3-year license)	ET-SWA100 Series*1
Digital Interface Box	ET-YFB100G
DIGITAL LINK Switcher	ET-YFB200G
Wireless Module	ET-WML100E / ET-WML100U*2

\*1 The suffix of the Model No. differs according to the license type.

\*2 In this document, the alphabet letters at the end of the model numbers are omitted.

### Note

- The model numbers of optional accessories are subject to change without prior notice.



# About your projector

## Remote control

### ■ Front

For PT-EZ590 / PT-EW650 / PT-EX620

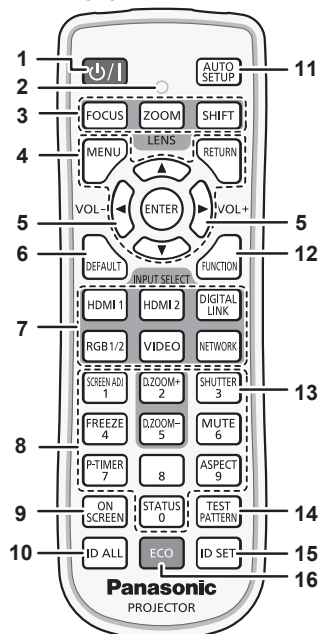

For PT-EW550 / PT-EX520

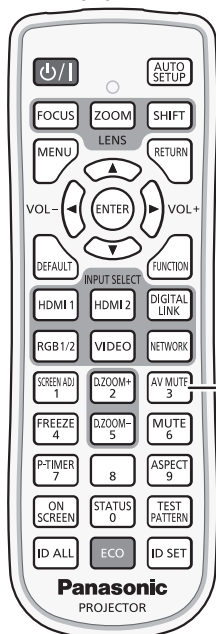

- 1 **Power <P>/<I> button** (⏻ standby/| power on)  
Sets the projector to the state where the projector is switched off (standby mode) when the <MAIN POWER> switch on the projector is set to <ON> and in the projection mode. Also starts projection when the power is switched off (standby mode).
- 2 **Remote control indicator**  
Blinks if any button in the remote control is pressed.
- 3 **Lens (<FOCUS>, <ZOOM>, <SHIFT>) buttons**  
Adjusts the projection lens. (➔ page 53)
- 4 **<MENU> button/<RETURN> button/<ENTER> button/ ▲▼◀▶ buttons**  
Used to navigate through the menu screen. (➔ page 63)
- 5 **<VOL-> button/<VOL+> button**  
Adjusts the volume of the built-in speaker or audio output. (➔ page 56)
- 6 **<DEFAULT> button**  
Resets the content of the sub-menu to the factory default. (➔ page 64)
- 7 **Input selection (<RGB1/2>, <DIGITAL LINK>\*1, <VIDEO>, <NETWORK>, <HDMI1>, <HDMI2>) buttons**  
Switches the input signal to project. (➔ page 52)  
(\*1 This button is disabled for PT-EW550 and PT-EX520.)
- 8 **Number (<0> ~ <9>) buttons**  
Used for entering an ID number or a password in a multiple projectors environment.
- 9 **<ON SCREEN> button**  
Switches on (display)/off (hide) the on-screen display function. (➔ page 56)
- 10 **<ID ALL> button**  
Used to simultaneously control all the projectors with a single remote control in a multiple projector environment. (➔ page 61)
- 11 **<AUTO SETUP> button**  
Automatically adjusts the image display position while the image is projected. (➔ page 57)

### ■ Top

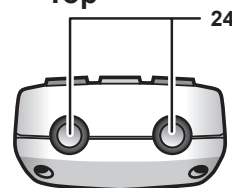

### ■ Bottom

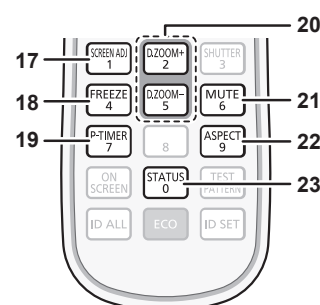
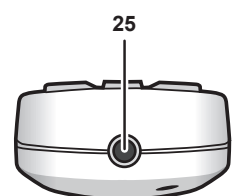

- 12 **<FUNCTION> button**  
Assigns a frequently used operation as a shortcut button. (➔ page 59)
- 13 **<SHUTTER> button/<AV MUTE> button**  
(<SHUTTER> button is for PT-EZ590, PT-EW650 and PT-EX620. <AV MUTE> button is for PT-EW550 and PT-EX520.)  
Used when temporarily turning off the image and the audio. (➔ page 55)
- 14 **<TEST PATTERN> button**  
Displays the test pattern. (➔ page 59)
- 15 **<ID SET> button**  
Sets the ID number of the remote control in a multiple projector environment. (➔ page 61)
- 16 **<ECO> button**  
Displays the setting screen relating to ECO management. (➔ pages 60, 94)
- 17 **<SCREEN ADJ> button**  
You can correct various types of distortion in a projected image. (➔ page 57)
- 18 **<FREEZE> button**  
Used when pausing the image and turning off the audio. (➔ page 56)
- 19 **<P-TIMER> button**  
Operates the presentation timer function. (➔ page 59)
- 20 **<D.ZOOM -> button/<D.ZOOM +> button**  
Zoom in and out the images. (➔ page 58)
- 21 **<MUTE> button**  
Used when temporarily turning off the audio. (➔ page 56)
- 22 **<ASPECT> button**  
Switches the aspect ratio of the image. (➔ page 58)
- 23 **<STATUS> button**  
Displays the projector information. (➔ pages 60, 93)
- 24 **Remote control signal transmitter**
- 25 **Remote control wired terminal**  
This is the terminal used to connect to the projector via a cable when the remote control is used as a wired remote control. (➔ page 29)

## Attention

- Do not drop the remote control.
- Avoid contact with liquids or moisture.
- Do not attempt to modify or disassemble the remote control.
- Please observe the following contents that are described on the back of the remote control unit (see the right picture).
  1. Do not use a new battery together with an old battery.
  2. Do not use unspecified batteries.
  3. Make sure the polarities (+ and -) are correct when inserting the batteries.
- In addition, please read the contents that are related to batteries in the "Read this first!".

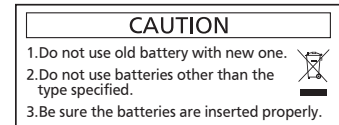

Caution label at the back of the remote control

## Note

- When operating the remote control by directly pointing the remote control signal receiver of the projector, operate the remote control at a distance approx. 30 m (98'5") or shorter from the remote control signal receiver. The remote control can control at angles of up to  $\pm 30^\circ$  vertically and horizontally, but the effective control range may be reduced.
- If there are any obstacles between the remote control and the remote control signal receiver, the remote control may not operate properly.
- The signal will be reflected off the screen. However, the operating range may be limited from light reflection loss due to the screen material.
- If the remote control signal receiver directly receives strong light, such as fluorescent light, the remote control may not operate properly. Use it in a place distant from the light source.
- The power indicator <ON (G)/STANDBY(R)> will blink if the projector receives a remote control signal.

## Projector body

### ■ Front

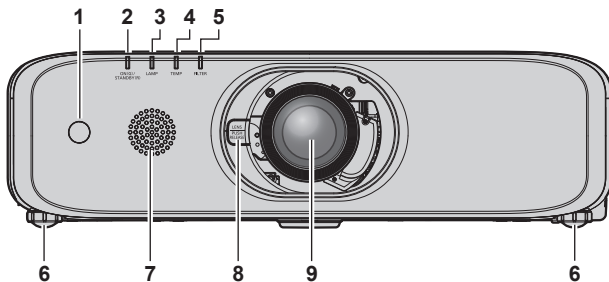

### ■ Side

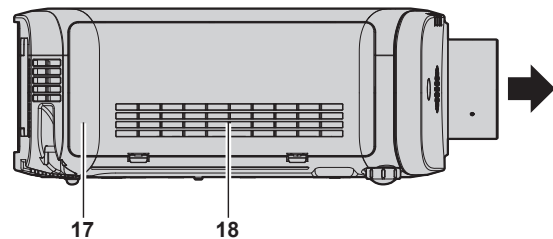

### ■ Rear

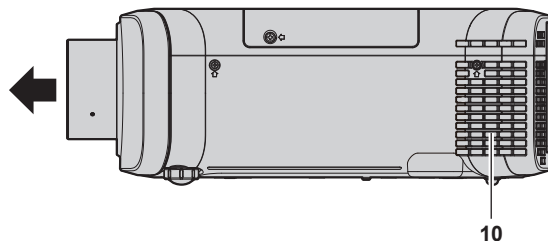
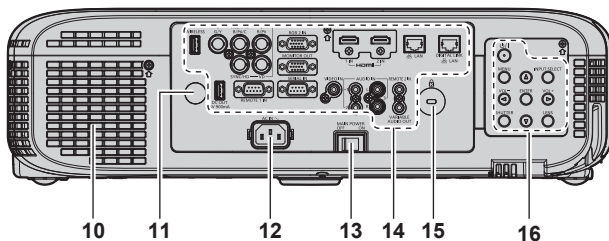

← : Projection direction

## WARNING

Keep your hands and other objects away from the air exhaust port.

- Keep your hands and face away.
- Do not insert your fingers.
- Keep heat-sensitive objects away.

Heated air from the air exhaust port can cause burns, injury, or deformations.

- 1 Remote control signal receiver (front)
- 2 Power indicator <ON (G)/STANDBY(R)>  
Displays the status of the power.
- 3 Lamp indicator <LAMP>  
Displays the status of the lamp.
- 4 Temperature indicator <TEMP>  
Displays the status of the internal temperature.

- 5 Filter indicator <FILTER>  
Displays the status of the air filter unit.
- 6 Adjustable feet  
Adjusts the projection angle.
- 7 Speaker
- 8 Lens release button (➡ page 39)
- 9 Projection lens  
(Only models with lens)
- 10 Air exhaust port
- 11 Remote control signal receiver (rear)
- 12 <AC IN> terminal  
Connect the supplied power cord.
- 13 <MAIN POWER> switch  
Turns off/on the main power.
- 14 Connecting terminals (➡ page 28)
- 15 Security slot  
This security slot is compatible with the Kensington security cables.

16 Control panel (➔ page 27)

17 Air filter cover  
The air filter unit is inside.

18 Air intake port

■ Bottom

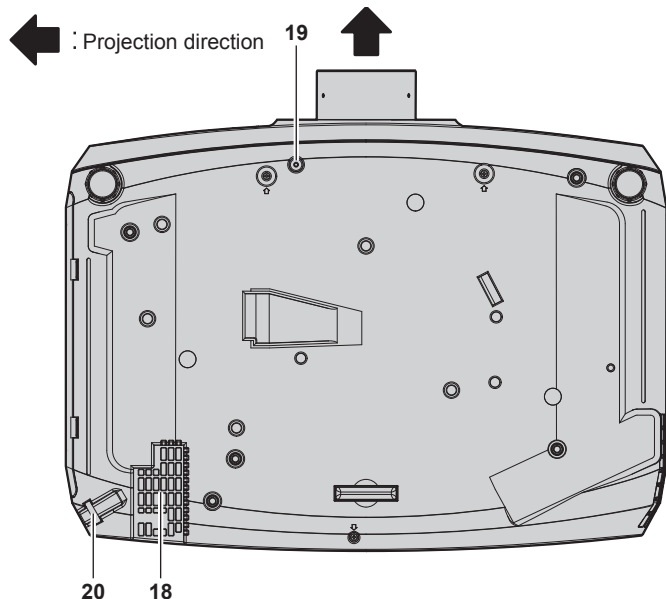

- 19 **Lens release button fixing screw hole**  
When you replace the projection lens, you can use if you want to fix the lens release button.
- 20 **Burglar hook port**  
Attaches a burglar prevention cable, etc.

■ Top

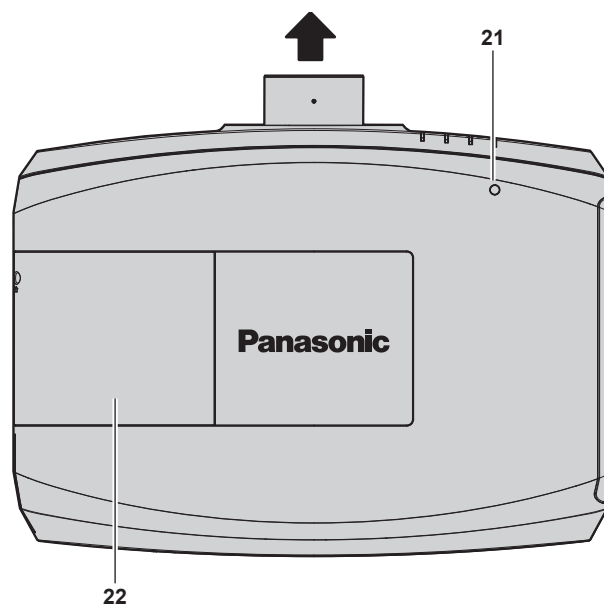

- 21 **Luminance sensor**  
Measures the brightness of the installation environment. When the daylight view function is set to [AUTO], the vividness of the image is automatically corrected. (➔ page 70)
- 22 **Lamp cover**  
The lamp unit is inside.

**Attention**

- Do not block the ventilation ports (intake and exhaust) of the projector.

■ Control panel

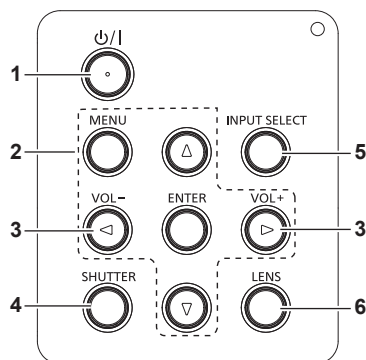

- 1 **Power <⏻/⏻> button (⏻ standby/| power on)**  
Sets the projector to the state where the projector is switched off (standby mode) when the <MAIN POWER> switch on the projector is set to <ON> and in the projection mode. Also starts projection when the power is switched off (standby mode).
- 2 **<MENU> button/<ENTER> button/▲▼◀▶ buttons**  
Used to navigate through the menu screen. (➔ page 63)  
Returns to the previous menu when a sub-menu is displayed. Also used to enter a password in [SECURITY] or enter characters.
- 3 **<VOL-> button/<VOL+> button**  
Adjusts the volume of audio output. (➔ page 56)
- 4 **<SHUTTER> button/<AV MUTE> button**  
(<SHUTTER> button is for PT-EZ590, PT-EW650 and PT-EX620.  
<AV MUTE> button is for PT-EW550 and PT-EX520.)  
Used when temporarily turning off the image and audio. (➔ page 55)
- 5 **<INPUT SELECT> button**  
Switches the input signal to project. (➔ page 52)
- 6 **<LENS> button**  
Adjusts the focus, zoom, and shift (position) of the lens.

■ Connecting terminals

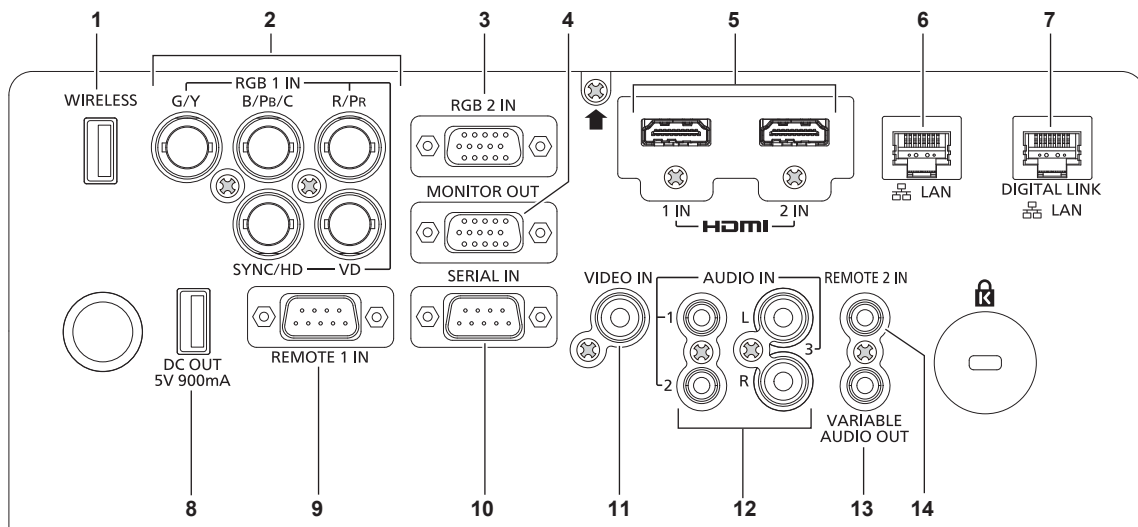

**1 <WIRELESS> terminal**

Insert the optional wireless module (Model No.: ET-WML100) directly to this terminal when using the wireless LAN function.

**2 <RGB 1 IN> (<G/Y>, <B/P<sub>B</sub>/C>, <R/P<sub>R</sub>>, <SYNC/HD>, <VD>) terminals**

This is the terminal to input RGB signals, YC<sub>B</sub>C<sub>R</sub>/YP<sub>B</sub>P<sub>R</sub> signals, or Y/C signals.

**3 <RGB 2 IN> terminal**

This is the terminal to input RGB signals or YC<sub>B</sub>C<sub>R</sub>/YP<sub>B</sub>P<sub>R</sub> signals.

**4 <MONITOR OUT> terminal**

This is the terminal to output analog RGB signals and YC<sub>B</sub>C<sub>R</sub>/YP<sub>B</sub>P<sub>R</sub> signals that were input to the <RGB 1 IN> terminal or the <RGB 2 IN> terminal to an external device. When the input is switched to RGB1 or RGB2, the corresponding signals are output.

**5 <HDMI 1 IN> terminal/<HDMI 2 IN> terminal**

This is the terminal to input HDMI signals.

**6 <LAN> terminal**

This is the LAN terminal to connect to the network.

**7 <DIGITAL LINK/LAN> terminal**

(Only for PT-EZ590, PT-EW650 and PT-EX620)

This is the LAN terminal to connect to the network. This is also used when connecting a video signal transmission device via the LAN terminal.

**8 <DC OUT> terminal**

This is a USB terminal only for power supply. (DC 5 V, maximum 900 mA)

This can be used when power is to be supplied to a wireless display adapter, etc.

**9 <REMOTE 1 IN> terminal**

This is a terminal to remotely control the projector using the external control circuit.

**10 <SERIAL IN> terminal**

This is the RS-232C compatible terminal to externally control the projector by connecting a computer.

**11 <VIDEO IN> terminal**

This is the terminal to input video signals.

**12 <AUDIO IN 1> terminal/<AUDIO IN 2> terminal/  
<AUDIO IN 3> terminal**

This is the terminal to input audio. Left input <L> and right input <R> are provided for the <AUDIO IN 3> terminal.

**13 <VARIABLE AUDIO OUT> terminal**

This is the terminal to output the input audio signal to the projector.

**14 <REMOTE 2 IN> terminal**

This is the terminal to connect to the remote control by cable when controlling the projector by wired remote control.

**Attention**

- When a LAN cable is directly connected to the projector, the network connection must be made indoors.

# Preparing the remote control

## Inserting and removing the batteries

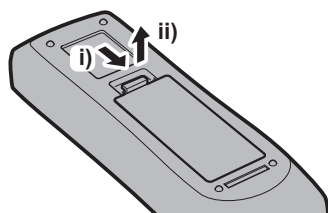

Fig. 1

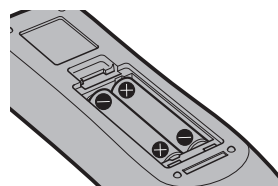



Fig. 2

- 1) Open the cover. (Fig. 1)
- 2) Insert the batteries and close the cover (insert the  side first). (Fig. 2)
  - When removing the batteries, perform the steps in reverse order.

## When using the system with multiple projectors

When you use the system with multiple projectors, you can operate all the projectors simultaneously or each projector individually by using single remote control, if a unique ID number is assigned to each projector.

When you want to set the ID number, at first you need to complete the Initial setting, and then after setting the ID number of the projector, set the ID number on the remote control.

About Initial setting, please refer to “When the initial setting screen is displayed” (➔ page 48).

The factory default ID number of the unit (the projector and the remote control) is set to [ALL], you can control with this setting. If necessary, please set the ID number to the remote control and the projector.

About how to set the ID number of the remote control, please refer to “Setting the ID number of the remote control” (➔ page 61).

### Note

- Set the ID number of the projector from the [PROJECTOR SETUP] menu → [PROJECTOR ID] (➔ page 93).

## Connecting the remote control to the projector with a cable

When you use the system with multiple projectors, use commercially available M3 stereo mini jack cables and connect the other devices to the <REMOTE 2 IN> terminal of the projector.

The remote control is effective even in places where an obstacle stands in the light path or where devices are susceptible to outside light.

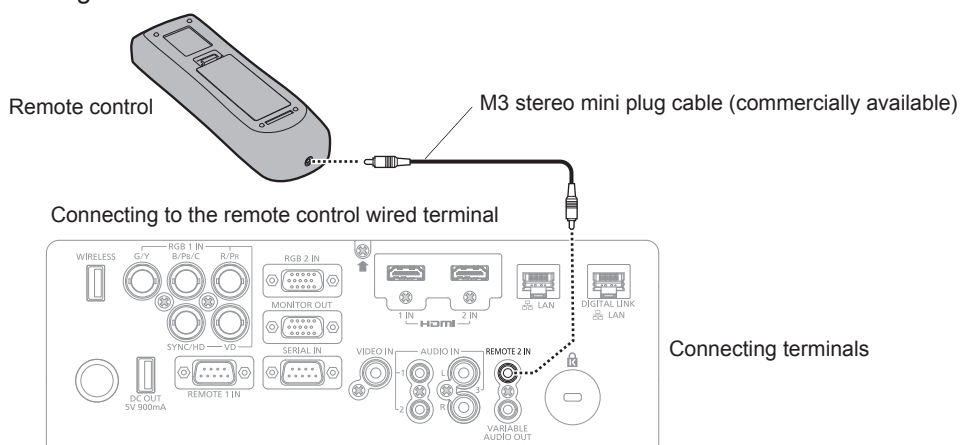

### Attention

- Use a cable that is 15 m (49'3") or shorter, with 2 core shielded. The remote control may not operate when the length of the cable exceeds 15 m (49'3") or when the shielding of the cable is inadequate.

# Chapter 2 **Getting Started**

---

This chapter describes things you need to do before using the projector such as the setup and connections.

# Setting up

## Installation mode

There are four ways to set up the projector. Set the [PROJECTOR SETUP] menu → [PROJECTION METHOD] (➔ page 94) depending on the installation method.

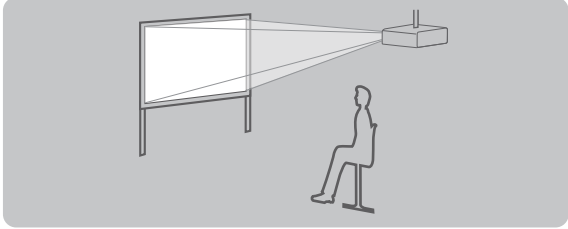
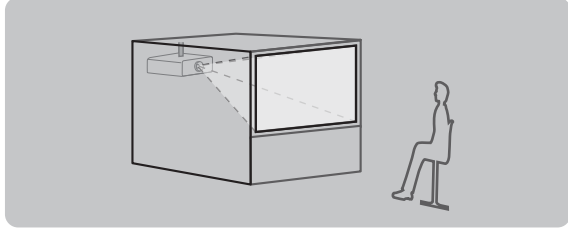
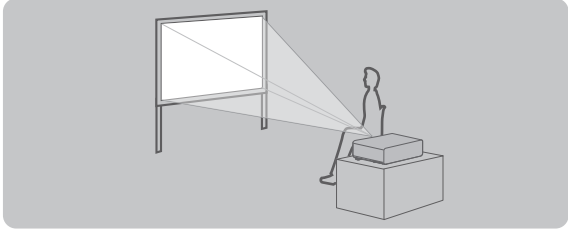
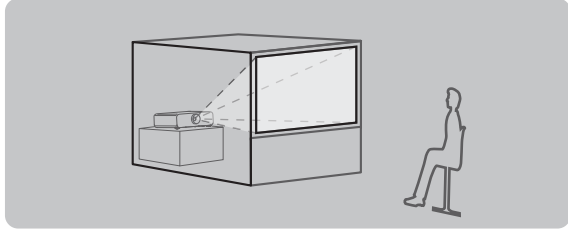
<b>Mounting on the ceiling and projecting forward</b> 		<b>Mounting on the ceiling and projecting from rear</b> (Using the translucent screen) 	
<b>Menu item</b>	<b>Method</b>	<b>Menu item</b>	<b>Method</b>
[PROJECTION METHOD]	[AUTO] or [FRONT/CEILING]	[PROJECTION METHOD]	[REAR/CEILING]
<b>Setting on a desk/floor and projecting forward</b> 		<b>Setting on a desk/floor and projecting from rear</b> (Using the translucent screen) 	
<b>Menu item</b>	<b>Method</b>	<b>Menu item</b>	<b>Method</b>
[PROJECTION METHOD]	[AUTO] or [FRONT/DESK]	[PROJECTION METHOD]	[REAR/DESK]

### Note

- The projector has a built-in angle sensor. When projecting in front of the screen, if set the [PROJECTOR SETUP] menu → [PROJECTION METHOD] → [AUTO], the projector's posture will be detected automatically. When projecting from rear, please set the [PROJECTION METHOD] to [REAR/DESK] or [REAR/CEILING].

### ■ Angle sensor

The range of installation posture detected by the projector's built-in angle sensor is as follows.

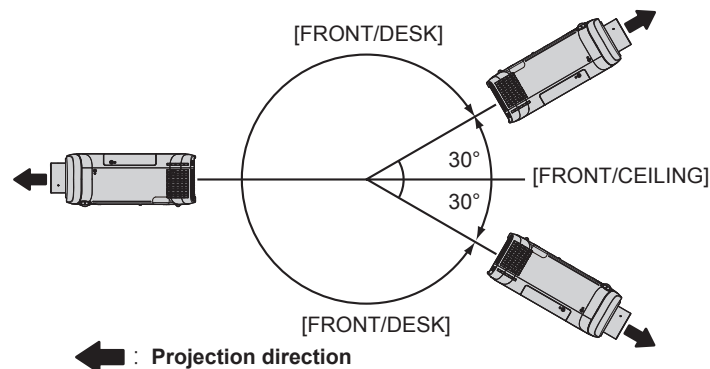

### Parts for ceiling mount (optional)

The projector can be installed on the ceiling by combining the optional Ceiling Mount Bracket (Model No.: ET-PKD120H (for High Ceilings), ET-PKD120S (for Low Ceilings)) and ET-PKE301B (Projector Mount Bracket).

- Be sure to use the Ceiling Mount Bracket specified for this projector.
- Refer to the Installation Instructions supplied with the Ceiling Mount Bracket when installing the projector with the bracket.

**Attention**

- To ensure projector performance and security, installation of the Ceiling Mount Bracket must be carried out by your dealer or a qualified technician.

**Projected image and throw distance**

Refer to the screen size and projection distances to install the projector. Image size and image position can be adjusted in accordance with the screen size and screen position.

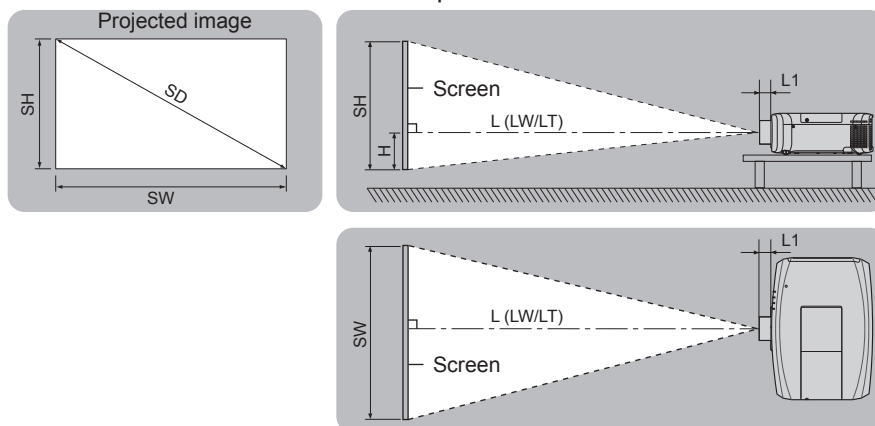

**Note**

- This illustration is represented on the assumption that the size and position of the projection screen are matched to fill the screen.

(Unit: m)

L (LW/LT) <sup>*1</sup>	Projection distance
L1	Lens protrusion dimension
SH	Projected image height
SW	Projected image width
H	Distance from the lens center to the bottom edge of the projected image (When setting on a desk/floor, if the bottom edge of the projected image is below the lens center, the value of H is positive.)
SD	Projected image size

\*1 LW: Minimum projection distance when the Zoom Lens is used  
 LT: Maximum projection distance when the Zoom Lens is used

(Unit: m)

Projection lens Model No.	Dimension for L1 (approximate value)
Standard zoom lens	0.040
ET-ELT30	0.081
ET-ELT31	0.092
ET-ELW30	0.071
ET-ELW31	0.070

**Attention**

- Before setting up, read "Precautions for use" (➔ page 17).

**[SCREEN ADJUSTMENT] projection range**

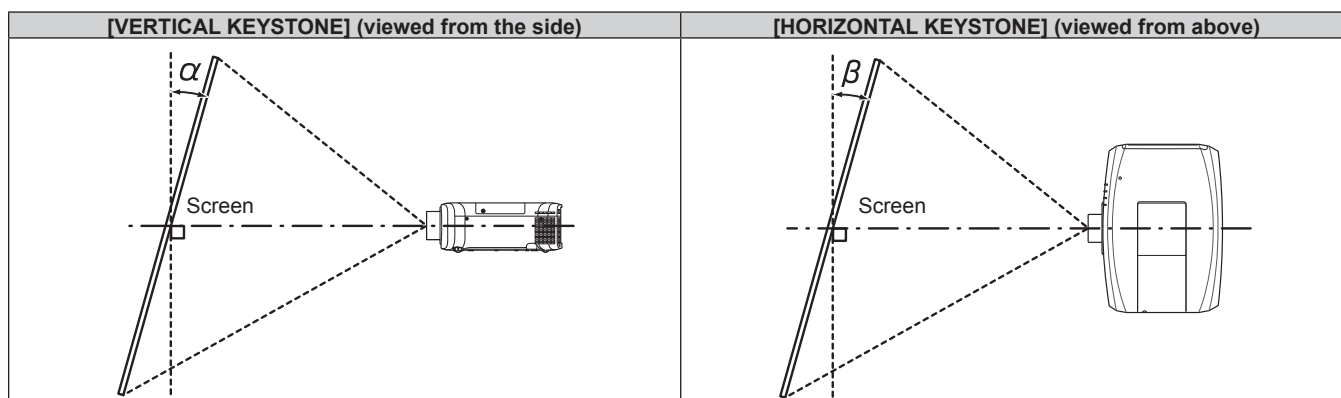



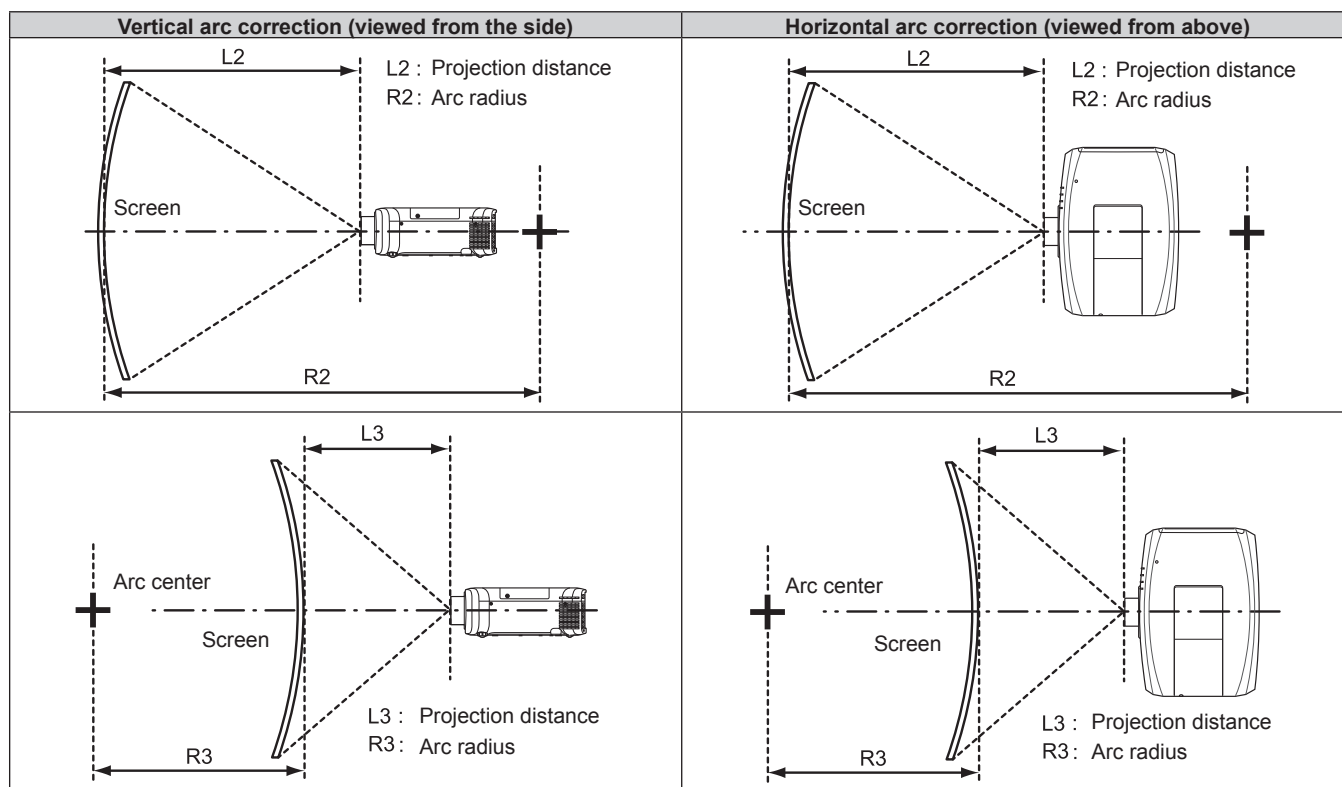

**For PT-EZ590**

Projection Lens Model No.	Only [KEYSTONE] used		[KEYSTONE] and [CURVED CORRECTION] used together				Only [CURVED CORRECTION] used	
	Vertical keystone correction angle $\alpha$ (°)	Horizontal keystone correction angle $\beta$ (°)	Vertical keystone correction angle $\alpha$ (°)	Horizontal keystone correction angle $\beta$ (°)	Min. value of R2/L2	Min. value of R3/L3	Min. value of R2/L2	Min. value of R3/L3
Standard zoom lens	±25	±30	±20	±15	1.4	2.9	0.7	1.6
ET-ELW31	±25	±20	±8	±8	2.0	4.9	1.2	3.0
ET-ELW30	±25	±30	±10	±10	1.6	3.9	0.9	2.3
ET-ELT30	±25	±30	±20	±15	0.7	1.4	0.4	0.8
ET-ELT31	±25	±30	±20	±15	0.4	0.8	0.2	0.4

**For PT-EW650 and PT-EW550**

Projection Lens Model No.	Only [KEYSTONE] used		[KEYSTONE] and [CURVED CORRECTION] used together				Only [CURVED CORRECTION] used	
	Vertical keystone correction angle $\alpha$ (°)	Horizontal keystone correction angle $\beta$ (°)	Vertical keystone correction angle $\alpha$ (°)	Horizontal keystone correction angle $\beta$ (°)	Min. value of R2/L2	Min. value of R3/L3	Min. value of R2/L2	Min. value of R3/L3
Standard zoom lens	±35	±35	±35	±35	1.0	1.0	1.0	1.0
ET-ELW31	±20	±20	±20	±20	2.9	2.9	2.9	2.9
ET-ELW30	±25	±25	±25	±25	1.8	1.8	1.8	1.8
ET-ELT30	±35	±35	±35	±35	0.4	0.4	0.4	0.4
ET-ELT31	±35	±35	±35	±35	0.2	0.2	0.2	0.2

For PT-EX620 and PT-EX520

Projection Lens Model No.	Only [KEYSTONE] used		[KEYSTONE] and [CURVED CORRECTION] used together				Only [CURVED CORRECTION] used	
	Vertical keystone correction angle $\alpha$ (°)	Horizontal keystone correction angle $\beta$ (°)	Vertical keystone correction angle $\alpha$ (°)	Horizontal keystone correction angle $\beta$ (°)	Min. value of R2/L2	Min. value of R3/L3	Min. value of R2/L2	Min. value of R3/L3
Standard zoom lens	±35	±35	±35	±35	0.8	0.9	0.8	0.9
ET-ELW31	±20	±20	±20	±20	2.5	2.5	2.5	2.5
ET-ELW30	±25	±25	±25	±25	1.6	1.6	1.6	1.6
ET-ELT30	±35	±35	±35	±35	0.4	0.4	0.4	0.4
ET-ELT31	±35	±35	±35	±35	0.4	0.4	0.4	0.4

Note

- When [SCREEN ADJUSTMENT] is used, the focus of the entire screen may be lost as correction increases.
- Make the curved screen a circular arc shape with one part of a perfect circle removed.

Projection distance per projection lens

A ± 5% error in listed projection distances may occur.

In addition, when [SCREEN ADJUSTMENT] is used, distance is corrected to become smaller than the specified screen size.

For PT-EZ590, PT-EW650, PT-EW550

■ When the image aspect ratio is 16:10

(Unit: m)

Lens type		Standard zoom lens	Optional lens										Height position (H)
			Short focus zoom lens		Short focus zoom lens		Long focus zoom lens		Ultra long focus zoom lens				
Projection Lens Model No.		—	ET-ELW31		ET-ELW30		ET-ELT30		ET-ELT31		ET-ELT31		Standard zoom lens / ET-ELW31 / ET-ELW30 / ET-ELT30 / ET-ELT31
Throw ratio <sup>*1</sup>		1.22-2.26:1	0.74-0.96:1		0.96-1.22:1		2.23-4.02:1		4.02-7.20:1				
Projected image size			Projection distance (L)										
Diagonal (SD)	Height (SH)	Width (SW)	Min. (LW)	Max. (LT)	Min. (LW)	Max. (LT)	Min. (LW)	Max. (LT)	Min. (LW)	Max. (LT)	Min. (LW)	Max. (LT)	
1.02 (40")	0.538	0.862	1.03	1.94	0.62	0.81	0.78	1.03	1.86	3.42	3.53	6.35	-0.05 ~ 0.59
1.27 (50")	0.673	1.077	1.29	2.42	0.78	1.02	0.98	1.29	2.35	4.29	4.37	7.88	-0.07 ~ 0.74
1.52 (60")	0.808	1.292	1.55	2.91	0.94	1.23	1.18	1.55	2.83	5.16	5.21	9.41	-0.08 ~ 0.89
1.78 (70")	0.942	1.506	1.82	3.41	1.10	1.44	1.39	1.82	3.33	6.06	6.08	11.00	-0.09 ~ 1.04
2.03 (80")	1.077	1.723	2.09	3.89	1.26	1.65	1.59	2.08	3.82	6.93	6.93	12.54	-0.11 ~ 1.18
2.29 (90")	1.212	1.939	2.36	4.40	1.43	1.87	1.79	2.35	4.32	7.84	7.80	14.13	-0.12 ~ 1.34
2.54 (100")	1.346	2.154	2.62	4.88	1.59	2.07	1.99	2.61	4.80	8.71	8.64	15.66	-0.13 ~ 1.48
3.05 (120")	1.615	2.585	3.15	5.87	1.91	2.50	2.40	3.14	5.79	10.49	10.35	18.79	-0.16 ~ 1.78
3.81 (150")	2.019	3.231	3.94	7.34	2.40	3.13	3.01	3.93	7.26	13.13	12.91	23.44	-0.20 ~ 2.22
5.08 (200")	2.692	4.308	5.27	9.79	3.21	4.18	4.02	5.25	9.71	17.55	17.18	31.23	-0.27 ~ 2.96
6.35 (250")	3.365	5.385	6.59	12.25	4.01	5.23	5.03	6.57	12.17	21.98	21.45	39.01	-0.34 ~ 3.70
7.62 (300")	4.039	6.462	7.92	14.71	4.82	6.29	6.05	7.89	14.63	26.40	25.72	46.79	-0.40 ~ 4.44
8.89 (350")	4.712	7.539	9.24	17.16	5.63	7.34	7.06	9.21	17.08	30.82	29.99	54.58	-0.47 ~ 5.18
10.16 (400")	5.385	8.616	10.57	19.62	6.44	8.39	8.07	10.53	19.54	35.25	34.26	62.36	-0.54 ~ 5.92

\*1 The throw ratio is based on the value during projection with the projected image size of 2.03 m (80").

### ■ When the image aspect ratio is 16:9

(Unit: m)

Lens type			Standard zoom lens		Optional lens								Height position (H)
					Short focus zoom lens		Short focus zoom lens		Long focus zoom lens		Ultra long focus zoom lens		
Projection Lens Model No.			—		ET-ELW31		ET-ELW30		ET-ELT30		ET-ELT31		Standard zoom lens / ET-ELW31 / ET-ELW30 / ET-ELT30 / ET-ELT31
Throw ratio*1			1.22-2.26:1		0.74-0.96:1		0.96-1.22:1		2.23-4.02:1		4.02-7.20:1		
Projected image size			Projection distance (L)										
Diagonal (SD)	Height (SH)	Width (SW)	Min. (LW)	Max. (LT)	Min. (LW)	Max. (LT)	Min. (LW)	Max. (LT)	Min. (LW)	Max. (LT)	Min. (LW)	Max. (LT)	
1.02 (40")	0.498	0.886	1.06	1.99	0.64	0.84	0.80	1.06	1.92	3.51	3.62	6.52	-0.08 ~ 0.58
1.27 (50")	0.622	1.107	1.33	2.49	0.80	1.05	1.01	1.32	2.41	4.41	4.49	8.09	-0.10 ~ 0.73
1.52 (60")	0.745	1.325	1.60	2.99	0.96	1.26	1.21	1.59	2.91	5.30	5.35	9.67	-0.12 ~ 0.87
1.78 (70")	0.872	1.552	1.88	3.51	1.13	1.48	1.43	1.87	3.43	6.23	6.25	11.31	-0.15 ~ 1.02
2.03 (80")	0.995	1.770	2.14	4.00	1.30	1.70	1.63	2.13	3.92	7.13	7.12	12.88	-0.17 ~ 1.16
2.29 (90")	1.122	1.997	2.42	4.52	1.47	1.92	1.84	2.41	4.44	8.06	8.01	14.52	-0.19 ~ 1.31
2.54 (100")	1.245	2.215	2.69	5.02	1.63	2.13	2.05	2.68	4.94	8.96	8.88	16.09	-0.21 ~ 1.45
3.05 (120")	1.495	2.660	3.24	6.03	1.97	2.57	2.47	3.22	5.95	10.78	10.64	19.31	-0.25 ~ 1.74
3.81 (150")	1.867	3.322	4.05	7.54	2.46	3.21	3.09	4.04	7.46	13.50	13.27	24.09	-0.31 ~ 2.18
5.08 (200")	2.489	4.430	5.42	10.07	3.30	4.30	4.13	5.39	9.99	18.05	17.66	32.09	-0.41 ~ 2.90
6.35 (250")	3.112	5.537	6.78	12.59	4.13	5.38	5.17	6.75	12.51	22.59	22.04	40.09	-0.52 ~ 3.63
7.62 (300")	3.734	6.645	8.14	15.11	4.96	6.46	6.22	8.11	15.04	27.14	26.43	48.09	-0.62 ~ 4.36
8.89 (350")	4.356	7.752	9.50	17.64	5.79	7.55	7.26	9.46	17.56	31.68	30.82	56.09	-0.73 ~ 5.08
10.16 (400")	4.978	8.860	10.86	20.16	6.62	8.63	8.30	10.82	20.09	36.23	35.21	64.09	-0.83 ~ 5.81

\*1 The throw ratio is based on the value during projection with the projected image size of 2.03 m (80").

### ■ When the image aspect ratio is 4:3

(Unit: m)

Lens type			Standard zoom lens		Optional lens								Height position (H)
					Short focus zoom lens		Short focus zoom lens		Long focus zoom lens		Ultra long focus zoom lens		
Projection Lens Model No.			—		ET-ELW31		ET-ELW30		ET-ELT30		ET-ELT31		Standard zoom lens / ET-ELW31 / ET-ELW30 / ET-ELT30 / ET-ELT31
Throw ratio*1			1.46-2.72:1		0.88-1.15:1		1.11-1.45:1		2.67-4.84:1		4.82-8.73:1		
Projected image size			Projection distance (L)										
Diagonal (SD)	Height (SH)	Width (SW)	Min. (LW)	Max. (LT)	Min. (LW)	Max. (LT)	Min. (LW)	Max. (LT)	Min. (LW)	Max. (LT)	Min. (LW)	Max. (LT)	
1.02 (40")	0.610	0.813	1.17	2.20	0.70	0.92	0.89	1.17	2.12	3.88	3.98	7.17	-0.06 ~ 0.67
1.27 (50")	0.762	1.016	1.47	2.75	0.88	1.16	1.11	1.46	2.67	4.87	4.93	8.91	-0.08 ~ 0.84
1.52 (60")	0.912	1.216	1.76	3.30	1.06	1.39	1.34	1.75	3.22	5.86	5.89	10.64	-0.09 ~ 1.00
1.78 (70")	1.068	1.424	2.07	3.86	1.25	1.64	1.57	2.06	3.79	6.88	6.88	12.44	-0.11 ~ 1.18
2.03 (80")	1.218	1.624	2.37	4.41	1.43	1.87	1.80	2.35	4.33	7.87	7.83	14.18	-0.12 ~ 1.34
2.29 (90")	1.374	1.832	2.67	4.98	1.62	2.12	2.04	2.66	4.90	8.89	8.82	15.98	-0.14 ~ 1.51
2.54 (100")	1.524	2.032	2.97	5.53	1.80	2.35	2.26	2.95	5.45	9.88	9.77	17.72	-0.15 ~ 1.68
3.05 (120")	1.830	2.440	3.57	6.65	2.17	2.83	2.72	3.56	6.57	11.89	11.71	21.26	-0.18 ~ 2.01
3.81 (150")	2.286	3.048	4.47	8.31	2.72	3.54	3.41	4.45	8.23	14.88	14.60	26.53	-0.23 ~ 2.52
5.08 (200")	3.048	4.064	5.97	11.09	3.63	4.74	4.56	5.94	11.01	19.89	19.44	35.34	-0.31 ~ 3.35
6.35 (250")	3.810	5.080	7.47	13.87	4.55	5.93	5.70	7.44	13.79	24.90	24.27	44.15	-0.38 ~ 4.19
7.62 (300")	4.572	6.096	8.97	16.65	5.47	7.12	6.85	8.93	16.57	29.90	29.10	52.96	-0.46 ~ 5.03
8.89 (350")	5.334	7.112	10.47	19.43	6.38	8.31	8.00	10.43	19.35	34.91	33.94	61.77	-0.53 ~ 5.87
10.16 (400")	6.096	8.128	11.97	22.21	7.30	9.51	9.14	11.92	22.14	39.92	38.77	70.59	-0.61 ~ 6.71

\*1 The throw ratio is based on the value during projection with the projected image size of 2.03 m (80").

## For PT-EX620 and PT-EX520

## ■ When the image aspect ratio is 4:3

(Unit: m)

Lens type			Standard zoom lens	Optional lens								Height position (H)
				Short focus zoom lens		Short focus zoom lens		Long focus zoom lens		Ultra long focus zoom lens		
Projection Lens Model No.			—	ET-ELW31		ET-ELW30		ET-ELT30		ET-ELT31		Standard zoom lens / ET-ELW31 / ET-ELW30 / ET-ELT30 / ET-ELT31
Throw ratio <sup>*1</sup>			1.32-2.44:1	0.79-1.08:1		1.00-1.30:1		2.39-4.36:1		4.34-7.86:1		
Projected image size			Projection distance (L)									
Diagonal (SD)	Height (SH)	Width (SW)	Min. (LW)	Max. (LT)	Min. (LW)	Max. (LT)	Min. (LW)	Max. (LT)	Min. (LW)	Max. (LT)	Min. (LW)	Max. (LT)
1.02 (40")	0.610	0.813	1.05	1.98	0.63	0.90	0.80	1.05	1.90	3.51	3.60	6.46
1.27 (50")	0.762	1.016	1.32	2.47	0.79	1.11	1.00	1.31	2.39	4.39	4.45	8.03
1.52 (60")	0.912	1.216	1.58	2.96	0.95	1.32	1.20	1.58	2.88	5.28	5.31	9.59
1.78 (70")	1.068	1.424	1.86	3.47	1.12	1.54	1.41	1.85	3.39	6.20	6.20	11.21
2.03 (80")	1.218	1.624	2.12	3.97	1.29	1.75	1.62	2.12	3.89	7.09	7.06	12.77
2.29 (90")	1.374	1.832	2.40	4.48	1.45	1.97	1.83	2.39	4.40	8.01	7.95	14.40
2.54 (100")	1.524	2.032	2.67	4.97	1.62	2.18	2.03	2.66	4.89	8.89	8.80	15.96
3.05 (120")	1.830	2.440	3.21	5.98	1.95	2.61	2.45	3.20	5.90	10.70	10.55	19.14
3.81 (150")	2.286	3.048	4.02	7.47	2.44	3.26	3.06	4.00	7.39	13.40	13.16	23.89
5.08 (200")	3.048	4.064	5.37	9.98	3.27	4.33	4.10	5.35	9.90	17.90	17.51	31.82
6.35 (250")	3.810	5.080	6.72	12.48	4.09	5.40	5.13	6.69	12.40	22.40	21.86	39.75
7.62 (300")	4.572	6.096	8.07	14.98	4.91	6.48	6.16	8.04	14.90	26.91	26.21	47.68
8.89 (350")	5.334	7.112	9.42	17.49	5.74	7.55	7.19	9.38	17.41	31.41	30.56	55.61
10.16 (400")	6.096	8.128	10.77	19.99	6.56	8.62	8.22	10.73	19.91	35.91	34.91	63.55

\*1 The throw ratio is based on the value during projection with the projected image size of 2.03 m (80").

## ■ When the image aspect ratio is 16:9

(Unit: m)

Lens type			Standard zoom lens	Optional lens								Height position (H)
				Short focus zoom lens		Short focus zoom lens		Long focus zoom lens		Ultra long focus zoom lens		
Projection Lens Model No.			—	ET-ELW31		ET-ELW30		ET-ELT30		ET-ELT31		Standard zoom lens / ET-ELW31 / ET-ELW30 / ET-ELT30 / ET-ELT31
Throw ratio <sup>*1</sup>			1.32-2.44:1	0.79-1.08:1		1.00-1.30:1		2.40-4.37:1		4.34-7.86:1		
Projected image size			Projection distance (L)									
Diagonal (SD)	Height (SH)	Width (SW)	Min. (LW)	Max. (LT)	Min. (LW)	Max. (LT)	Min. (LW)	Max. (LT)	Min. (LW)	Max. (LT)	Min. (LW)	Max. (LT)
1.02 (40")	0.498	0.886	1.15	2.16	0.69	0.97	0.87	1.14	2.08	3.83	3.91	7.03
1.27 (50")	0.622	1.107	1.44	2.69	0.87	1.20	1.09	1.43	2.61	4.79	4.84	8.74
1.52 (60")	0.745	1.325	1.73	3.23	1.04	1.43	1.31	1.72	3.15	5.76	5.77	10.44
1.78 (70")	0.872	1.552	2.03	3.79	1.23	1.67	1.54	2.02	3.71	6.76	6.75	12.21
2.03 (80")	0.995	1.770	2.32	4.32	1.40	1.90	1.76	2.31	4.25	7.73	7.68	13.91
2.29 (90")	1.122	1.997	2.62	4.88	1.59	2.14	1.99	2.61	4.80	8.73	8.65	15.68
2.54 (100")	1.245	2.215	2.91	5.42	1.76	2.37	2.22	2.90	5.34	9.70	9.58	17.38
3.05 (120")	1.495	2.660	3.50	6.51	2.12	2.84	2.67	3.48	6.44	11.67	11.49	20.85
3.81 (150")	1.867	3.322	4.38	8.15	2.66	3.54	3.34	4.36	8.07	14.61	14.32	26.02
5.08 (200")	2.489	4.430	5.85	10.87	3.56	4.71	4.47	5.83	10.79	19.51	19.06	34.66
6.35 (250")	3.112	5.537	7.32	13.60	4.46	5.88	5.59	7.29	13.52	24.42	23.81	43.30
7.62 (300")	4.572	6.096	8.79	16.33	5.36	7.05	6.71	8.76	16.25	29.32	28.55	51.94
8.89 (350")	5.334	7.112	10.26	19.05	6.26	8.22	7.84	10.22	18.97	34.23	33.29	60.58
10.16 (400")	6.096	8.128	11.73	21.78	7.15	9.39	8.96	11.69	21.70	39.13	38.03	69.22

\*1 The throw ratio is based on the value during projection with the projected image size of 2.03 m (80").

## Formula to calculate projection distance per projection lens

To use a screen size not listed in this manual, check the screen size SD (m) and use the respective formula to calculate projection distance.

The unit of all the formulae is m. (Values obtained by the following calculation formulae contain a slight error.)

When calculating a projection distance using image size designation (value in inches), multiply the value in inches by 0.0254 and substitute it into SD in the formula for calculating the projection distance.

## Chapter 2 Getting Started — Setting up

### For PT-EZ590, PT-EW650, PT-EW550

Lens type	Projection Lens Model No.	Aspect ratio	Projection distance (L) formula	
			Min. (LW)	Max. (LT)
Standard zoom lens	—	16:10	Min. (LW)	$L = 1.0433 \times SD - 0.0326$
			Max. (LT)	$L = 1.9341 \times SD - 0.0328$
		16:9	Min. (LW)	$L = 1.0724 \times SD - 0.0326$
			Max. (LT)	$L = 1.9878 \times SD - 0.0328$
		4:3	Min. (LW)	$L = 1.1811 \times SD - 0.0326$
			Max. (LT)	$L = 2.1895 \times SD - 0.0328$
Short focus zoom lens	ET-ELW31	16:10	Min. (LW)	$L = 0.6373 \times SD - 0.0324$
			Max. (LT)	$L = 0.8295 \times SD - 0.0344$
		16:9	Min. (LW)	$L = 0.6550 \times SD - 0.0324$
			Max. (LT)	$L = 0.8526 \times SD - 0.0344$
		4:3	Min. (LW)	$L = 0.7215 \times SD - 0.0324$
			Max. (LT)	$L = 0.9391 \times SD - 0.0344$
Short focus zoom lens	ET-ELW30	16:10	Min. (LW)	$L = 0.7978 \times SD - 0.0326$
			Max. (LT)	$L = 1.0395 \times SD - 0.0341$
		16:9	Min. (LW)	$L = 0.8199 \times SD - 0.0326$
			Max. (LT)	$L = 1.0684 \times SD - 0.0341$
		4:3	Min. (LW)	$L = 0.9031 \times SD - 0.0326$
			Max. (LT)	$L = 1.1768 \times SD - 0.0341$
Long focus zoom lens	ET-ELT30	16:10	Min. (LW)	$L = 1.9341 \times SD - 0.1109$
			Max. (LT)	$L = 3.4825 \times SD - 0.1364$
		16:9	Min. (LW)	$L = 1.9879 \times SD - 0.1109$
			Max. (LT)	$L = 3.5793 \times SD - 0.1364$
		4:3	Min. (LW)	$L = 2.1896 \times SD - 0.1109$
			Max. (LT)	$L = 3.9424 \times SD - 0.1364$
Ultra long focus zoom lens	ET-ELT31	16:10	Min. (LW)	$L = 3.3622 \times SD + 0.1001$
			Max. (LT)	$L = 6.1287 \times SD + 0.0940$
		16:9	Min. (LW)	$L = 3.4557 \times SD + 0.1001$
			Max. (LT)	$L = 6.2991 \times SD + 0.0940$
		4:3	Min. (LW)	$L = 3.8063 \times SD + 0.1001$
			Max. (LT)	$L = 6.9382 \times SD + 0.0940$

### For PT-EX620 and PT-EX520

Lens type	Projection Lens Model No.	Aspect ratio	Projection distance (L) formula	
			Min. (LW)	Max. (LT)
Standard zoom lens	—	4:3	Min. (LW)	$L = 1.0630 \times SD - 0.0332$
			Max. (LT)	$L = 1.9706 \times SD - 0.0334$
		16:9	Min. (LW)	$L = 1.1581 \times SD - 0.0332$
			Max. (LT)	$L = 2.1469 \times SD - 0.0334$
Short focus zoom lens	ET-ELW31	4:3	Min. (LW)	$L = 0.6493 \times SD - 0.0330$
			Max. (LT)	$L = 0.8452 \times SD + 0.0350$
		16:9	Min. (LW)	$L = 0.7074 \times SD - 0.0330$
			Max. (LT)	$L = 0.9208 \times SD + 0.0350$
Short focus zoom lens	ET-ELW30	4:3	Min. (LW)	$L = 0.8128 \times SD - 0.0333$
			Max. (LT)	$L = 1.0591 \times SD - 0.0347$
		16:9	Min. (LW)	$L = 0.8855 \times SD - 0.0333$
			Max. (LT)	$L = 1.1539 \times SD - 0.0347$

Lens type	Projection Lens Model No.	Aspect ratio	Projection distance (L) formula	
Long focus zoom lens	ET-ELT30	4:3	Min. (LW)	$L = 1.9706 \times SD - 0.1130$
			Max. (LT)	$L = 3.5456 \times SD - 0.1114$
		16:9	Min. (LW)	$L = 2.1469 \times SD - 0.1130$
			Max. (LT)	$L = 3.8628 \times SD - 0.1114$
Ultra long focus zoom lens	ET-ELT31	4:3	Min. (LW)	$L = 3.4264 \times SD + 0.1005$
			Max. (LT)	$L = 6.2453 \times SD + 0.0941$
		16:9	Min. (LW)	$L = 3.7330 \times SD + 0.1005$
			Max. (LT)	$L = 6.8041 \times SD + 0.0941$

## Adjusting adjustable feet

Install the projector on a flat surface so that the front of the projector is parallel to the screen surface and the projected image is rectangular.

If the screen is tilted downward, the projected image can be adjusted to be rectangular by adjusting the front adjustable feet. The adjustable feet can also be used to adjust the projector to be level when it is tilted in the horizontal direction.

Extend the adjustable feet by rotating in the direction shown in the figure and retract by rotating in the opposite direction.

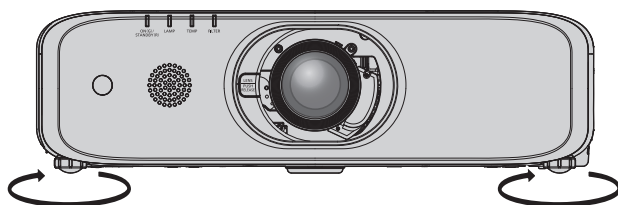

**Maximum adjustable range**  
Adjustable feet: 23 mm (29/32") each

### Attention

- Heated air is expelled from the air exhaust port while the lamp is lit. Do not touch the air exhaust port directly when adjusting the adjustable feet. (➔ page 26)

## Removing/attaching the projection lens

Removing and attaching procedures of the projection lens are same for both standard zoom lens and optional lens.

Move the projection lens to the home position before replacing or removing the projection lens. (➔ page 54)

### Attention

- Replace the projection lens after turning off the projector.
- Do not touch the electrical contact of the projection lens. Dust or dirt may cause defective contact.
- Do not touch the surface of the projection lens with your bare hands.
- Before attaching the projection lens, remove the lens pad (only lens options models) and the lens cover attached to the projection lens.

### Removing the projection lens

Remove the projection lens with the following procedure.

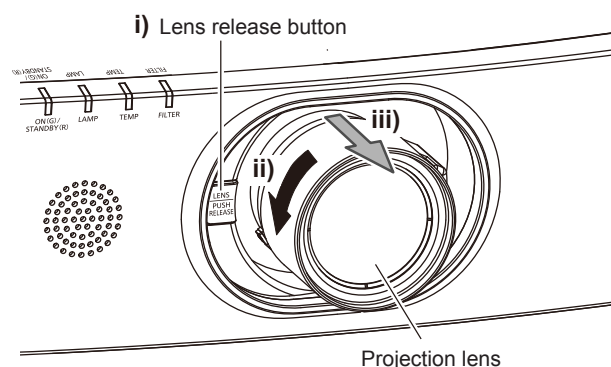

- 1) With the lens release button held down, turn the projection lens counterclockwise to the end and remove the projection lens.

### Attention

- Store the removed projection lens where it will be free from vibration and impact.
- If you cannot release the lock with lens release button held down, it indicates that the lens release button fixing screw is installed. Please remove the lens release button fixing screw. For details, refer to "When attaching the lens release button fixing screw". (➔ page 40)

### Attaching the projection lens

Attach the projection lens with the following procedure.

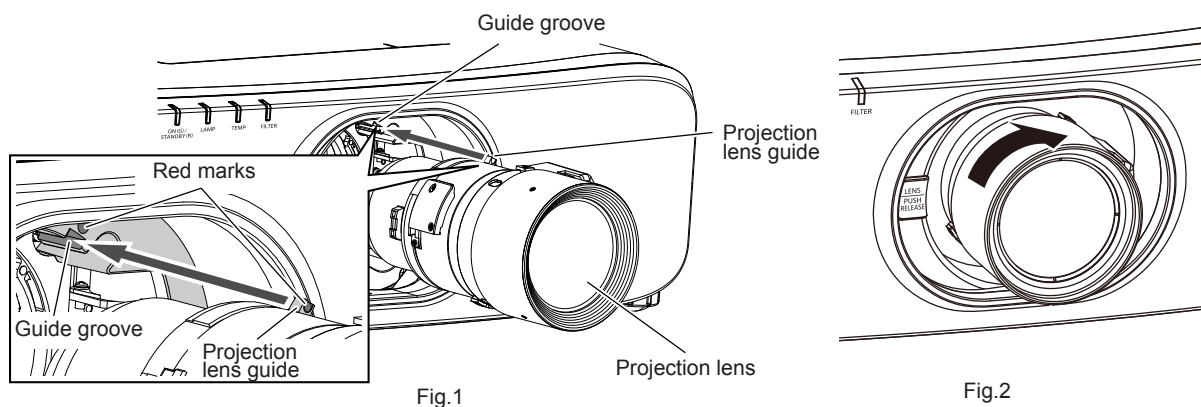

- 1) Align the red mark on the projection lens with the red mark on the projector, and insert the projection lens to the end. (Fig. 1)
- 2) Turn the projection lens clockwise until it clicks. (Fig. 2)

### Attention

- Turn the projection lens counterclockwise to confirm that it does not come out.

### When attaching the lens release button fixing screw

Attach the lens anti-theft screw with the following procedures.

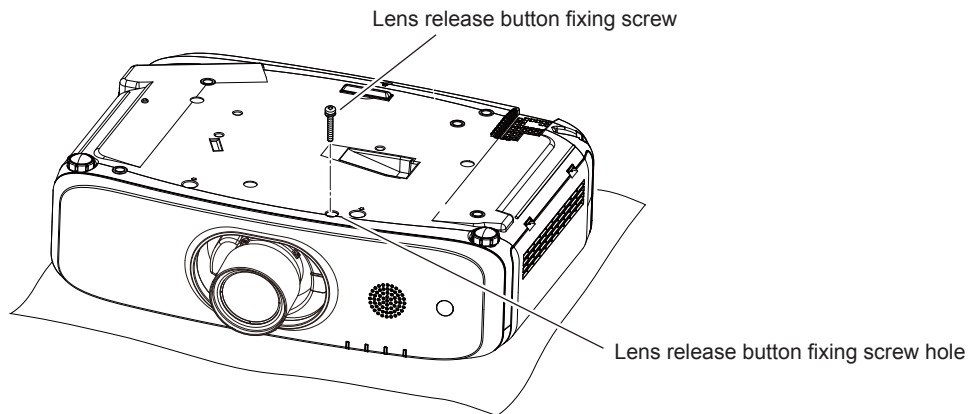

- 1) Place the projector upside down on a soft cloth.
- 2) Use a Phillips screwdriver to firmly tighten the lens release button fixing screw into the lens release button fixing screw hole.
  - The projection lens cannot be removed with the lens release button held down.



# Connecting

## Before connecting

- Before connecting, carefully read the operating instructions for the external device to be connected.
- Turn off the power of all devices before connecting cables.
- Take note of the following points before connecting the cables. Failure to do so may result in malfunctions.
  - When connecting a cable to a device connected to the projector or the projector itself, touch any nearby metallic objects to eliminate static electricity from your body before performing work.
  - Do not use unnecessarily long cables to connect a device to the projector or to the projector body. The longer the cable, the more susceptible to noise it becomes. Since using a cable while it is wound makes it act like an antenna, it is more susceptible to noise.
  - When connecting cables, connect GND first, then insert the connecting terminal of the connecting device in a straight manner.
- Acquire any connection cable necessary to connect the external device to the system that is neither supplied with the device nor available as an option.
- If video signals from video equipment contain too much jitter, the images on the screen may wobble. In this case, a time base corrector (TBC) must be connected.
- The projector accepts video signals, Y/C signals, YC<sub>B</sub>C<sub>R</sub>/YP<sub>B</sub>P<sub>R</sub> signals, analog RGB signals (synchronization signals are TTL level), and digital signals.
- Some computer models or graphics cards are not compatible with the projector.
- Use a cable compensator when you connect devices to the projector using long cables. Otherwise the image may not display properly.
- Refer to “List of compatible signals” (➔ page 157) for the types of video signals that can be used with the projector.

## <RGB 2 IN> terminal pin assignments and signal names

Outside view	Pin No.	Signal name	Pin No.	Signal name
	(1)	R/P <sub>R</sub>	(9)	+5 V
	(2)	G/Y	(10)	GND
	(3)	B/P <sub>B</sub>	(11)	GND
	(4)	—	(12)	DDC data
	(5)	GND	(13)	HD/SYNC
	(6)	GND	(14)	VD
	(7)	GND	(15)	DDC clock
	(8)	GND		

## <MONITOR OUT> terminal pin assignments and signal names

Outside view	Pin No.	Signal name	Pin No.	Signal name
	(1)	R/P <sub>R</sub>	(9)	—
	(2)	G/Y	(10)	GND
	(3)	B/P <sub>B</sub>	(11)	GND
	(4)	—	(12)	—
	(5)	GND	(13)	HD/SYNC
	(6)	GND	(14)	VD
	(7)	GND	(15)	—
	(8)	GND		

**<HDMI 1 IN> terminal/<HDMI 2 IN> terminal pin assignments and signal names**

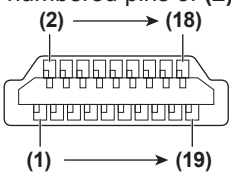
Outside view	Pin No.	Signal name	Pin No.	Signal name
Even-numbered pins of (2) to (18) 	(1)	T.M.D.S data 2+	(11)	T.M.D.S clock shield
	(2)	T.M.D.S data 2 shield	(12)	T.M.D.S clock-
	(3)	T.M.D.S data 2-	(13)	CEC
	(4)	T.M.D.S data 1+	(14)	—
	(5)	T.M.D.S data 1 shield	(15)	SCL
	(6)	T.M.D.S data 1-	(16)	SDA
Odd-numbered pins of (1) to (19)	(7)	T.M.D.S data 0+	(17)	DDC/CEC GND
	(8)	T.M.D.S data 0 shield	(18)	+5 V
	(9)	T.M.D.S data 0-	(19)	Hot plug detection
	(10)	T.M.D.S clock+		

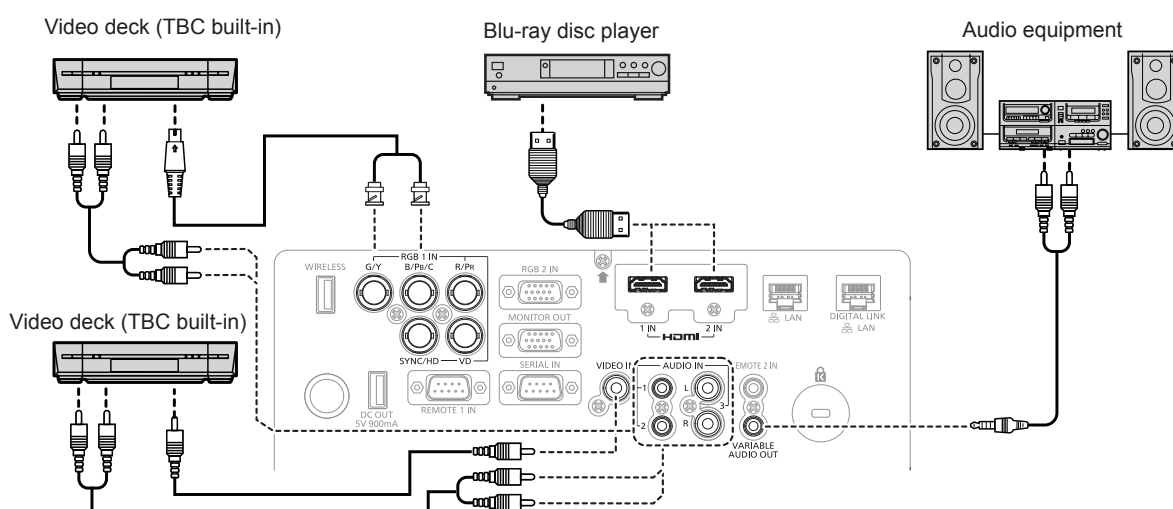
**Connecting example: AV equipment**

**Attention**

- Always use one of the following when connecting a VCR.
  - A VCR with built-in time base corrector (TBC)
  - A time base corrector (TBC) between the projector and the VCR
- If nonstandard burst signals are connected, the image may be distorted. In such case, connect the time base corrector (TBC) between the projector and the external devices.

**Note**

- For an HDMI cable, use an HDMI High Speed cable that conforms to HDMI standards. If a cable that does not conform to HDMI standards is used, images may be interrupted or may not be displayed.
- The <HDMI 1 IN> terminal/<HDMI 2 IN> terminal of the projector can be connected to an external device with a DVI-D terminal by using an HDMI/DVI conversion cable, but some devices may not project the image properly or function properly.
- The projector does not support VIERA Link (HDMI).
- If the [AUDIO IN SELECT] settings are incorrect, the projector may have malfunctions such as the absence of audio.
- When Y/C signals are input to the <RGB 1 IN> terminal, switch the setting by using the [DISPLAY OPTION] menu → [RGB IN] → [RGB1 INPUT SETTING]. (➔ page 83)

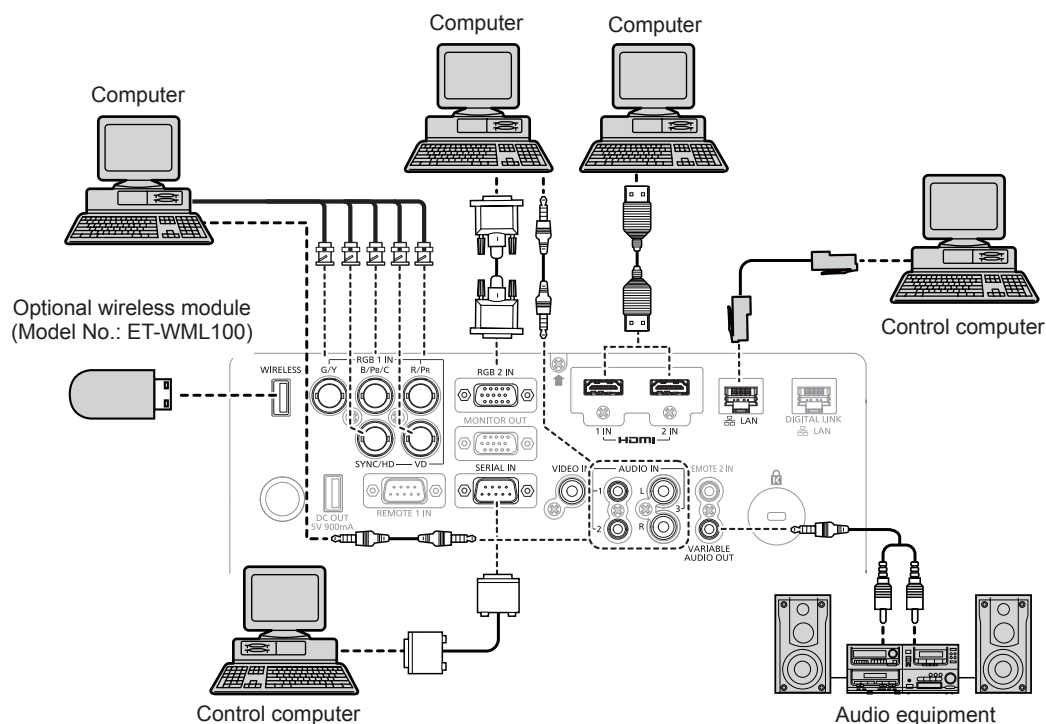
## Connecting example: Computers



### Attention

- When connecting the projector to a computer or an external device, use the power cord supplied with each device and commercially available shielded cables.

### Note

- For an HDMI cable, use an HDMI High Speed cable that conforms to HDMI standards. If a cable that does not conform to HDMI standards is used, images may be interrupted or may not be displayed.
- The <HDMI 1 IN> terminal/<HDMI 2 IN> terminal of the projector can be connected to an external device with a DVI-D terminal by using an HDMI/DVI conversion cable, but some devices may not project the image properly or function properly.
- When inputting the SYNC ON GREEN signal, do not input sync signals to the <SYNC/HD> terminal or the <VD> terminal.
- If you operate the projector using the computer with the resume feature (last memory), you may have to reset the resume feature to operate the projector.
- If the [AUDIO IN SELECT] settings are incorrect, the projector may have malfunctions such as the absence of audio.

## Connecting example using DIGITAL LINK

(Only for PT-EZ590, PT-EW650 and PT-EX620)

Twisted-pair-cable transmitters based on the communication standard HDBaseT™ such as the optional DIGITAL LINK output supported device (Model No.: ET-YFB100G, ET-YFB200G) use twisted pair cables to transmit input images, Ethernet, and serial control signals, and the projector can input those digital signals to the <DIGITAL LINK/LAN> terminal.

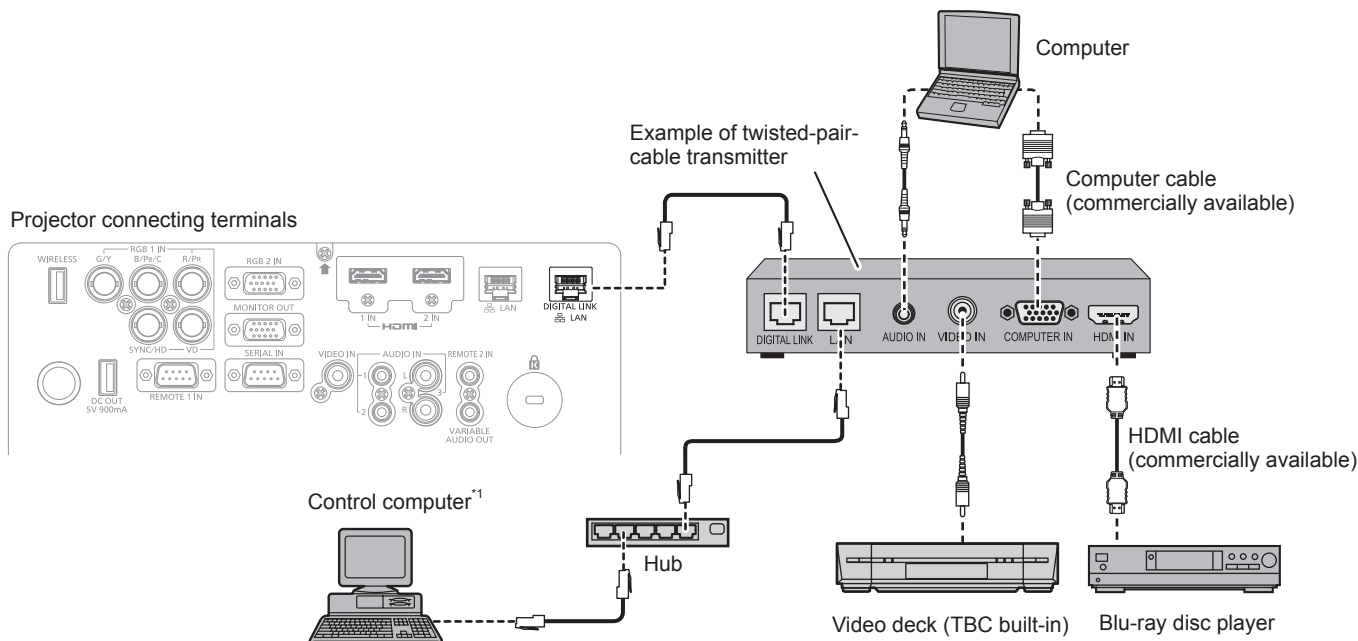

\*1 The control target will be the projector or the twisted-pair-cable transmitter. The control itself may not be possible depending on the twisted-pair-cable transmitter. Check the operating instructions of the device to be connected.

### Attention

- Always use one of the following when connecting a VCR.
  - A VCR with built-in time base corrector (TBC)
  - A time base corrector (TBC) between the projector and the VCR
- If nonstandard burst signals are connected, the image may be distorted. In such a case, connect the time base corrector (TBC) between the projector and the external devices.
- Ask a qualified technician or your dealer to install the cable wiring for a twisted-pair-cable transmitter and the projector. Image and sound may be disrupted if cable transmission characteristics cannot be obtained due to inadequate installation.
- For the LAN cable between the twisted-pair-cable transmitter and the projector, use a cable that meets the following criteria:
  - Compatible with CAT5e or higher
  - Shielded type (including connectors)
  - Straight-through
  - Single wire
- When laying cables between the twisted-pair-cable transmitter and the projector, check that cable characteristics are compatible with CAT5e or higher using tools such as a cable tester or cable analyzer. When a relay connector is used, include it in the measurement.
- Do not use a hub between the twisted-pair-cable transmitter and the projector.
- When connecting to the projector using a twisted-pair-cable transmitter (receiver) of other manufacturer, do not place another twisted-pair-cable transmitter between the twisted-pair-cable transmitter of other manufacturer and the projector. This may cause image and sound to be disrupted.
- Do not pull cables forcefully. In addition, do not bend or fold cables unnecessarily.
- To reduce the effects of noise as much as possible, stretch out the cables between the twisted-pair-cable transmitter and the projector without any loops.
- Lay the cables between a twisted-pair-cable transmitter and the projector away from other cables, particularly power cables.
- When laying multiple cables, run them side by side along the shortest distance possible without bundling them together.
- After laying the cables, confirm that the value of [SIGNAL QUALITY] in the [NETWORK] menu → [DIGITAL LINK STATUS] is displayed in green to indicate normal quality. (➡ page 108)

### Note

- For an HDMI cable, use an HDMI High Speed cable that conforms to HDMI standards. If a cable that does not conform to HDMI standards is used, images may be interrupted or may not be displayed.
- The projector does not support VIERA Link (HDMI).
- The maximum transmission distance between the twisted-pair-cable transmitter and the projector is 100 m (328'1"). It is possible to transmit up to 150 m (492'2") if the twisted-pair-cable transmitter supports the long-reach communication method. If this distance is exceeded, image may be disrupted or a malfunction may occur in LAN communication. Please note that we do not support the use of the projector outside the maximum transmission distance. When connecting with the long reach, there may be a limitation to the video signal that can be transmitted or the distance depending on the specification of the twisted-pair-cable transmitter.
- For twisted-pair-cable transmitters of other manufacturers of which the operation has been verified with the projector, refer to the Panasonic website (<https://panasonic.net/cns/projector/>). Note that the verification for devices of other manufacturers has been made for the items set by Panasonic Corporation, and not all the operations have been verified. For operation or performance problems caused by the devices of other manufacturers, contact the respective manufacturers.

# Chapter 3 Basic Operations

---

This chapter describes basic operations to start with.

# Switching on/off the projector

## Connecting the power cord

Make sure that the supplied power cord is securely fixed to the projector body to prevent it from being removed easily.

Confirm that the <MAIN POWER> switch is on the <OFF> side before connecting the power cord.

Use the power cord matching with the power supply voltage and the shape of the outlet.

For details of power cord handling, refer to “Read this first!” (➔ page 4).

## Attaching the power cord

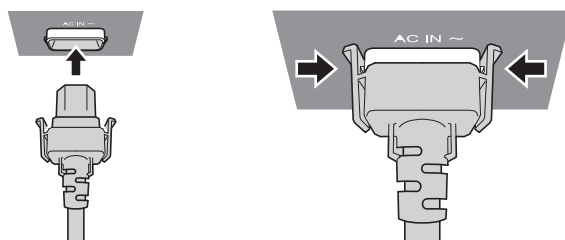

- 1) Check the shapes of the <AC IN> terminal on the rear of the projector body and the power cord connector, and insert the plug completely in the correct direction (until you hear the side tabs click in place).

## Removing the power cord

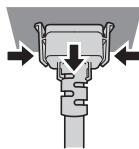

- 1) Confirm that the <MAIN POWER> switch on the rear of the projector body is on the <OFF> side, and remove the power plug from the outlet.
- 2) Remove the power cord connector from the <AC IN> terminal of the projector body while pressing the side tabs.

## Power indicator

Displays the status of the power. Check the status of the power indicator <ON (G)/STANDBY(R)> before operating the projector.

Power indicator <ON (G)/STANDBY(R)>

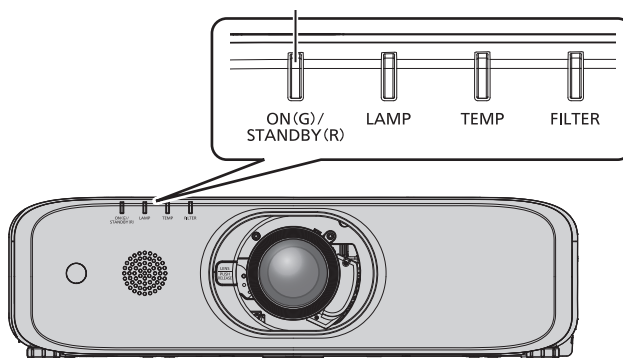

Indicator status		Projector status	
Off		The main power is switched off.	
Red	Lit	The power is switched off (Standby mode). The [PROJECTOR SETUP] menu → [ECO MANAGEMENT] → [STANDBY MODE] is set to [ECO]. Projection will start when the power button <⏻/> is pressed.	<ul style="list-style-type: none"> <li>• The projector may not operate when the lamp indicator &lt;LAMP&gt; or the temperature indicator &lt;TEMP&gt; is blinking. (➔ page 138)</li> </ul>
	Blinking <sup>*1</sup>	The power is switched off (Standby mode). The [PROJECTOR SETUP] menu → [ECO MANAGEMENT] → [STANDBY MODE] is set to [NORMAL]. Projection will start when the power button <⏻/> is pressed.	

Indicator status		Projector status
Green	Lit	Projecting.
	Blinking	The power is still on while the lamp is turned off. The [PROJECTOR SETUP] menu → [ECO MANAGEMENT] → [POWER MANAGEMENT] is set to [READY]. <sup>*2</sup>
		The shutter function is in use (shutter: closed). <sup>*3</sup>
		The lamp starts work. The projector will project image after a while. <sup>*4</sup>
Orange	Lit	The projector is preparing to be switched off. The power is switched off after a while. (Changes to the standby mode.)

\*1 The indicator flashes in the cycle: 2.75 seconds (light) → 0.25 seconds (off).

\*2 The indicator flashes in the cycle: 2.0 seconds (light) → 2.0 seconds (off).

\*3 The indicator flashes in the cycle: 0.8 seconds (light) → 0.8 seconds (off). (Only for PT-EZ590, PT-EW650 and PT-EX620)

\*4 The indicator flashes in the cycle: 0.5 seconds (light) → 0.5 seconds (off).

### Note

- While the power indicator <ON (G)/STANDBY(R)> is lit in orange, the fan is running to cool the projector.
- For about 90 seconds after the projector is switched off and the luminous lamp cooling is started, the luminous lamp does not light up even if the power is switched on. After the power indicator <ON (G)/STANDBY(R)> lights or blinks in red, turn on the power again.
- The projector consumes power even in standby mode (power indicator <ON (G)/STANDBY(R)> lights or blinks in red). Refer to “Power consumption” (➔ page 159) for the power consumption.
- The power indicator <ON (G)/STANDBY(R)> will blink if the projector receives a remote control signal.
- If the power indicator <ON (G)/STANDBY(R)> is blinking 3 times in red, consult your dealer.

## Switching on the projector

When using the optional projection lens, attach the projection lens before switching on the projector.

Before switching on the projector, make sure all the other devices are correctly connected (➔ page 41) and remove the lens cover first.

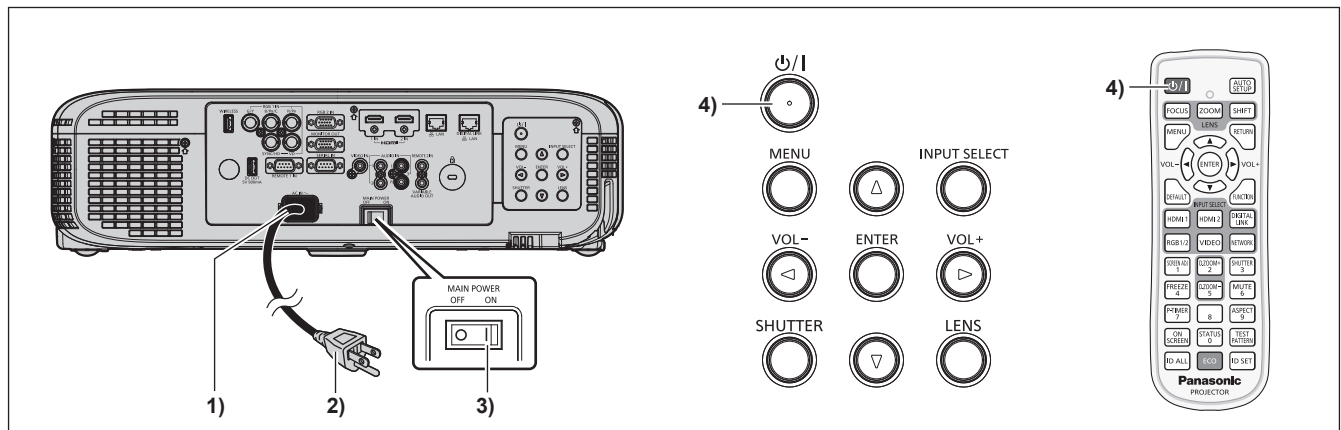

- 1) **Connect the power cord to the projector body.**
- 2) **Connect the power plug to an outlet.**
- 3) **Press the <ON> side of the <MAIN POWER> switch to turn on the power.**
  - The power indicator <ON (G)/STANDBY(R)> lights or blinks in red, and the projector enters the standby mode.
- 4) **Press the power <ON/OFF> button.**
  - The power indicator <ON (G)/STANDBY(R)> lights in green and the image is soon projected on the screen.

### Attention

- Be sure to remove the lens cover before starting projection.

### Note

- If the [PROJECTOR SETUP] menu → [ECO MANAGEMENT] → [STANDBY MODE] is set to [ECO], it may take approx. 10 seconds longer before the projector starts projecting after the power is turned on, compared with when [NORMAL] is set.
- If the [PROJECTOR SETUP] menu → [ECO MANAGEMENT] → [STANDBY MODE] is set to [NORMAL], it may take approx. 1 minute to enable the network function after connecting the power cord.
- If the [PROJECTOR SETUP] menu → [INITIAL STARTUP] is set to [LAST MEMORY] and the projector was turned off by using the circuit breaker directly while projecting during the last time of use, the power indicator <ON (G)/STANDBY(R)> will light in green a while after the circuit breaker is turned on, and then projection of the image will start.

## When the initial setting screen is displayed

When the projector is switched on for the first time after purchase as well as when [INITIALIZE ALL] in the [PROJECTOR SETUP] menu is executed, the focus adjustment screen is displayed after projection starts, then the [INITIAL SETTING] screen is displayed. Set them in accordance with circumstances.

In other occasions, you can change the settings by menu operations.

If you press the <RETURN> button or the <MENU> button while the [INITIAL SETTING] screen is displayed, you can go back to the previous screen.

### Focus adjustment

Adjust the focus to display the menu screen clearly.

You may also need to adjust the zoom and shift.

Refer to “Adjusting the focus, zoom, and shift” (➔ page 53) for details.

- 1) Press ▲▼◀▶ to adjust the focus.

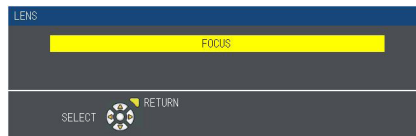

- 2) Press the <MENU> button to proceed to the initial setting.

### Initial setting (display language)

Select the language to show on the screen.

After the initial setting completed, you can change the display language from the [LANGUAGE] menu.

- 1) Press ▲▼◀▶ to select the display language.



- 2) Press the <ENTER> button to proceed to the initial setting.

### Initial setting (projector setting)

Set each item.



- 1) Press ▲▼ to select an item.

Item	Description	Page
[PROJECTION METHOD]	Set [PROJECTION METHOD] depending on the installation mode. For details, refer to “Installation mode” (➔ page 31). After the initial setting is completed, you can change the setting from the [PROJECTOR SETUP] menu → [PROJECTION METHOD].	31, 94



[SCREEN FORMAT]	Set the screen format (aspect ratio) and display position of the image. After the initial setting is completed, you can change the settings of each item from the [DISPLAY OPTION] menu → [SCREEN SETTING].	87
[SCREEN POSITION]	Set the display position of the image. After the initial setting is completed, you can change the settings of each item from the [DISPLAY OPTION] menu → [SCREEN SETTING].	87
[STANDBY MODE]	Set the operation mode during standby. The default setting is [NORMAL], you can use the network function during standby. If you want to reduce the power consumption, it can be set to [ECO]. After the initial setting is completed, you can change the setting from the [PROJECTOR SETUP] menu → [ECO MANAGEMENT] → [STANDBY MODE].	95

- 2) Press ◀▶ to switch the setting.
- 3) Press the <ENTER> button to proceed to the initial setting.

### Initial setting (time zone)

Set [TIME ZONE] according to the country or region where the projector is used. After the initial setting completed, you can change the setting from the [PROJECTOR SETUP] menu → [DATE AND TIME]. The current settings are displayed in [LOCAL DATE] and [LOCAL TIME].

- 1) Press ▲▼ to switch the setting.



- 2) Press the <ENTER> button to proceed to the initial setting.

#### Note

- By default, the time zone of the projector is set to +09:00 (Japan and Korean Standard Time). Change the setting in the [PROJECTOR SETUP] menu → [DATE AND TIME] → [TIME ZONE] to the time zone of the region where you use the projector.

### Initial setting (date and time)

Set the local date and time. After the initial setting is completed, you can change the setting from the [PROJECTOR SETUP] menu → [DATE AND TIME].

To set the date and time automatically, refer to “Setting the date and time automatically” (➔ page 103).

- 1) Press ▲▼ to select an item.

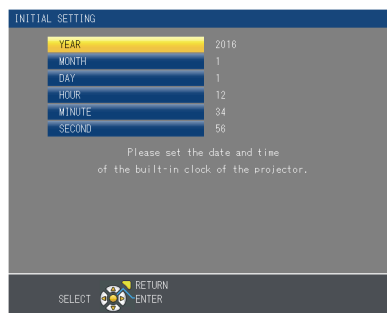

- 2) Press ◀▶ to switch the setting.

- 3) Press the <ENTER> button.
  - Confirm the setting value and complete the initial setting.

## Making adjustments and selections

It is recommended that images be projected continuously for at least 30 minutes before the focus is adjusted.

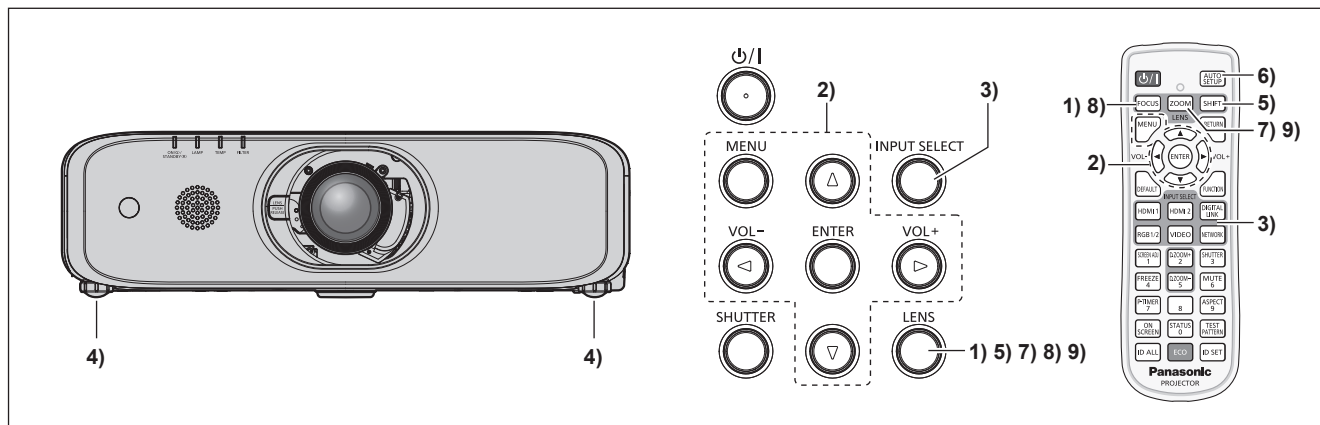

- 1) Press the <FOCUS> button to roughly adjust the focus of the image. (➡ page 53)
- 2) Change the setting of the [PROJECTOR SETUP] menu → [PROJECTION METHOD] depending on the installation mode. (➡ page 94)
  - Refer to “Navigating through the menu” (➡ page 63) for the operation of the menu screen.
- 3) Press the <INPUT SELECT> button on the control panel or the input selection (<HDMI1>, <HDMI2>, <DIGITAL LINK><sup>\*1</sup>, <RGB1/2>, <VIDEO>, <NETWORK>) buttons on the remote control to select the input signal.
  - \*1 Only for PT-EZ590, PT-EW650 and PT-EX620
- 4) Adjust the front, back and sideways tilt of the projector with the adjustable feet. (➡ page 38)
- 5) Press the <SHIFT> button to adjust the position of the image.
- 6) If the input signal is the RGB signal, press the <AUTO SETUP> button.
- 7) Press the <ZOOM> button to adjust the size of the image to match the screen.
- 8) Press the <FOCUS> button again to adjust the focus.
- 9) Press the <ZOOM> button again to adjust the zoom and the size of the image to match the screen.

### Note

- When the projector is switched on for the first time after purchase as well as when [INITIALIZE ALL] in the [PROJECTOR SETUP] menu is executed, the focus adjustment screen is displayed after projection starts, then the [INITIAL SETTING] screen is displayed. Refer to “When the initial setting screen is displayed” (➡ page 48).

## Switching off the projector

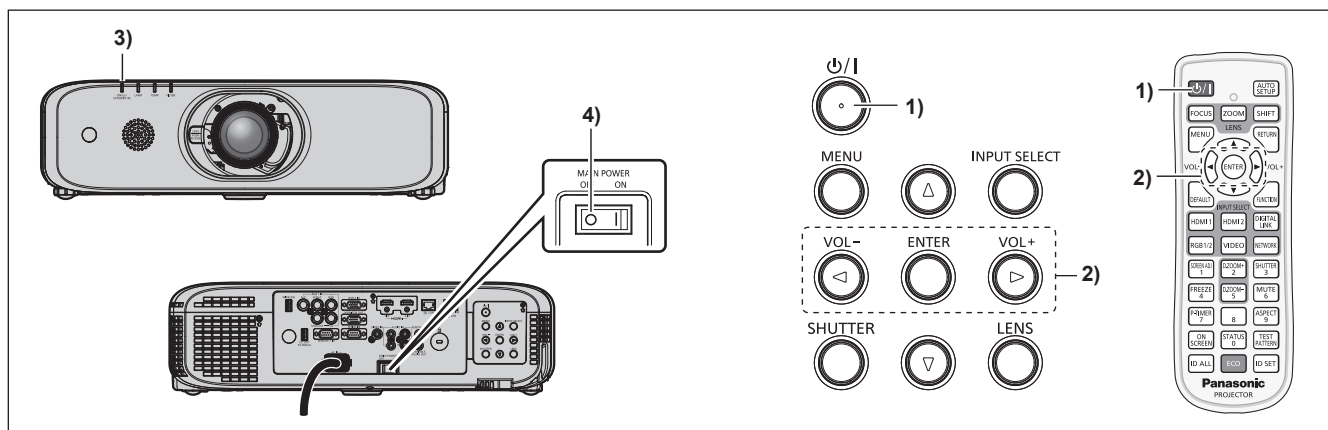

- 1) Press the power  $\langle \text{ON/OFF} \rangle$  button.
  - The [POWER OFF] confirmation screen is displayed.

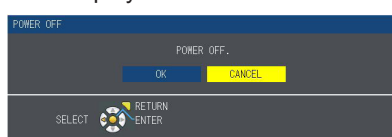

- 2) Press  $\langle \text{LEFT/RIGHT} \rangle$  to select [OK], and press the  $\langle \text{ENTER} \rangle$  button.  
(Or press the power  $\langle \text{ON/OFF} \rangle$  button again.)
  - Projection of the image will stop, and the power indicator  $\langle \text{ON (G)/STANDBY(R)} \rangle$  on the projector body lights in orange. (The fan keeps running.)
- 3) Wait until the power indicator  $\langle \text{ON(G)/STANDBY(R)} \rangle$  lights or blinks in red.
- 4) Press the  $\langle \text{OFF} \rangle$  side of the  $\langle \text{MAIN POWER} \rangle$  switch to turn off the power.

### Note

- Do not switch on the projector and project images immediately after switching off the projector. Turning on the power while the lamp is still hot may shorten the life of the lamp.
- For about 90 seconds after the projector is switched off and the luminous lamp cooling is started, the luminous lamp will not light up even if the power is switched on. In such a case, switch on the projector again after the power indicator  $\langle \text{ON (G)/STANDBY(R)} \rangle$  lights in red.
- The projector consumes power even when the power  $\langle \text{ON/OFF} \rangle$  button is pressed and the projector is switched off if the main power of the projector is on.  
When the [PROJECTOR SETUP] menu  $\rightarrow$  [ECO MANAGEMENT]  $\rightarrow$  [STANDBY MODE] is set to [ECO], use of some functions is restricted, but the power consumption during standby can be conserved.

## Direct power off function

The projector can be turned off during projection or immediately after the luminous lamp is turned off by setting the  $\langle \text{MAIN POWER} \rangle$  switch to  $\langle \text{OFF} \rangle$ . In addition, when the projector is mounted on the ceiling or installed in an environment where the  $\langle \text{MAIN POWER} \rangle$  switch of the projector cannot be easily turned  $\langle \text{OFF} \rangle$ , the power can be turned off directly using the circuit breaker. It is also safe in case a power outage occurs or the power cord is pulled out immediately after the projector is switched off.

### Attention

- Do not set the  $\langle \text{MAIN POWER} \rangle$  switch to  $\langle \text{OFF} \rangle$  or turn off the power breaker switch in a short time (about 1 minute) after the lamp is lit. Doing so may cause the lamp fail to light while you powering on the projector next time, or result in premature deterioration of the lamp.

### Note

- If the [PROJECTOR SETUP] menu  $\rightarrow$  [INITIAL STARTUP] is set to [LAST MEMORY] and the projector was turned off by using the circuit breaker directly while projecting during the last time of use, the power indicator  $\langle \text{ON (G)/STANDBY(R)} \rangle$  will light in green a while after the circuit breaker is turned on, and then projection of the image will start.
- If the projector is cooled with the direct power off function, it may take longer than usual to be ready for projection when the projector is switched on the next time.

# Projecting

Check the attachment of the projection lens (➔ page 39), external device connection (➔ page 41), power cord connection (➔ page 46), and switch on the projector (➔ page 47) to start projecting. Select the image for projection, and adjust appearance of the projected image.

## Selecting the input signal

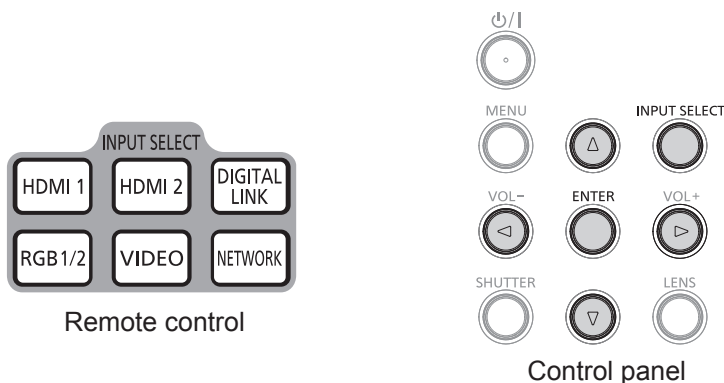

The input for projection can be switched. Method to switch the input is as follows.

- Press the input selection buttons on the remote control and directly specify the input to project.
- Press the <INPUT SELECT> button on the control panel to display the input selection screen and select the input to project from the list.

## Switching the input directly via remote control

The input for projection can be switched directly by pressing the input selection button on the remote control.

- 1) **Press the input selection (<HDMI1>, <HDMI2>, <DIGITAL LINK>\*1, <RGB1/2>, <VIDEO>, <NETWORK>) buttons.**
  - Switches the input, the input guide of the selected input terminal displayed on the top right of the projection screen.

<HDMI1>	Switches the input to HDMI1. The image of the signal being input in the <HDMI 1 IN> terminal is projected.
<HDMI2>	Switches the input to HDMI2. The image of the signal being input in the <HDMI 2 IN> terminal is projected.
<DIGITAL LINK>*1	Switches the input to DIGITAL LINK. The image of the signal being input in the <DIGITAL LINK/LAN> terminal is projected.
<RGB1/2>	Switches the input to RGB1 or RGB2. If one input is already selected, it will be switched to the other input. The image of the signal being input in the <RGB 1 IN> terminal or the <RGB 2 IN> terminal is projected.
<VIDEO>	Switches the input to VIDEO. The image of the signal being input in the <VIDEO IN> terminal is projected.
<NETWORK>	Switches the input to NETWORK.

\*1 <DIGITAL LINK> button is disabled for PT-EW550 and PT-EX520.

## Attention

- Images may not be projected properly depending on the external device, or the Blu-ray disc or DVD disc, to be played back. Set the [PICTURE] menu → [RGB/YC<sub>B</sub>C<sub>R</sub>]/[RGB/YP<sub>B</sub>P<sub>R</sub>]. (➔ page 71)
- Confirm the aspect ratio of the projection screen and the image, and switch to an optimum aspect ratio from the [POSITION] menu → [ASPECT]. (➔ page 79)

## Note

- (Only for PT-EZ590, PT-EW650 and PT-EX620)  
When the optional DIGITAL LINK output supported device (Model No.: ET-YFB100G, ET-YFB200G) is connected to the <DIGITAL LINK/LAN> terminal, the input on the DIGITAL LINK output supported device changes each time the <DIGITAL LINK> button is pressed. The input can also be changed using the RS-232C control command.  
For twisted-pair-cable transmitters of other manufacturers, switch the input on the projector to DIGITAL LINK, and then switch the input on the twisted-pair-cable transmitter.
- Configure [RGB1 INPUT SETTING] of the [DISPLAY OPTION] menu → [RGB IN] (➔ page 83) to match the signal to be input to the <RGB 1 IN> terminal.

## Switching the input by displaying the input guide

The input for projection can be selected by displaying the input guide with the control panel.

- 1) **Press the <INPUT SELECT> button on the control panel.**
  - The [DETAILED] input guide or the [SIMPLE] input guide is displayed. (➔ page 82)
- 2) **Press the <INPUT SELECT> button again.**
  - The input will switch each time you press the <INPUT SELECT> button.
  - You can also select the input source by pressing ▲▼◀▶ on the remote control or the control panel from the [DETAILED] input guide.

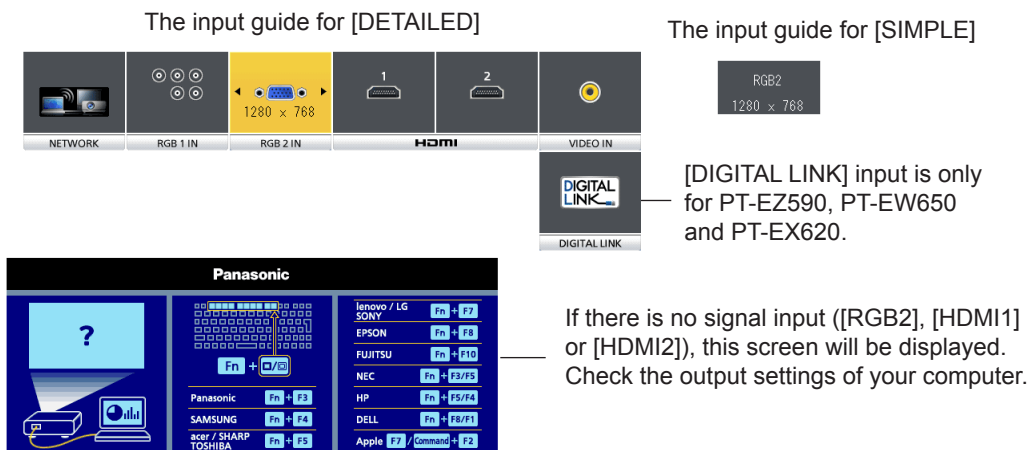

### Note

- The input guide for [DETAILED]/[SIMPLE], you can change the setting from the [DISPLAY OPTION] menu → [ON-SCREEN DISPLAY] → [INPUT GUIDE].

## Adjusting the focus, zoom and shift

If the projected image or the position is not correct when the positioning of the projector and the screen is correctly installed, adjust the focus, zoom, and shift.

### Using the control panel

- 1) **Press the <LENS> button on the control panel.**
  - Pressing the button changes the adjustment screen in the order of [FOCUS], [ZOOM] and [SHIFT].
- 2) **Select each item and press ▲▼◀▶ to adjust it.**

### Using the remote control

- 1) **Press the lens (<FOCUS>, <ZOOM>, <SHIFT>) buttons on the remote control.**
  - <FOCUS> button: Adjusts focus.
  - <ZOOM> button: Adjusts zoom.
  - <SHIFT> button: Adjusts shift.
- 2) **Select each item and press ▲▼◀▶ to adjust it.**

## CAUTION

During the lens shift operation, do not insert your hand in any opening around the lens.  
Your hand may be caught in between, resulting in injury.

### Note

- When adjust zoom or focus, the adjustment can be performed quickly by pressing and holding ▲▼◀▶ for at least three seconds.
- When adjust shift, the adjustment can be performed quickly by pressing and holding ▲▼◀▶ for at least six seconds.
- It is recommended that images be projected continuously for at least 30 minutes before the focus is adjusted.
- Only [FOCUS] is shown in yellow so that the displayed menu item can be recognized by color, even when the projector is not focused and displayed characters are unreadable. (Factory default)

## Moving the lens to the home position

To move the lens to the home position, perform the following procedure.

- 1) While the [SHIFT] adjustment screen is displayed, press the <DEFAULT> button on the remote control.

- The [HOME POSITION] screen is displayed.

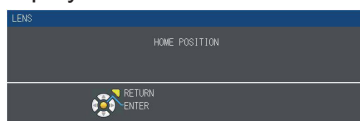

- 2) While the [HOME POSITION] screen is displayed (for approximately five seconds), press the <ENTER> button.

- [Return to HOME POSITION.] is displayed during in progress, and the lens returns to the home position.

### Note

- You can also display the [HOME POSITION] screen by pressing the <LENS> button on the control panel or the <SHIFT> button on the remote control for at least three seconds.

## Adjustment range by the lens position shift (optical axis shift)

The projection position can be adjusted in the range shown in the following figure with the optical axis shift function based on the position of the projected screen in the home position (standard projection position).

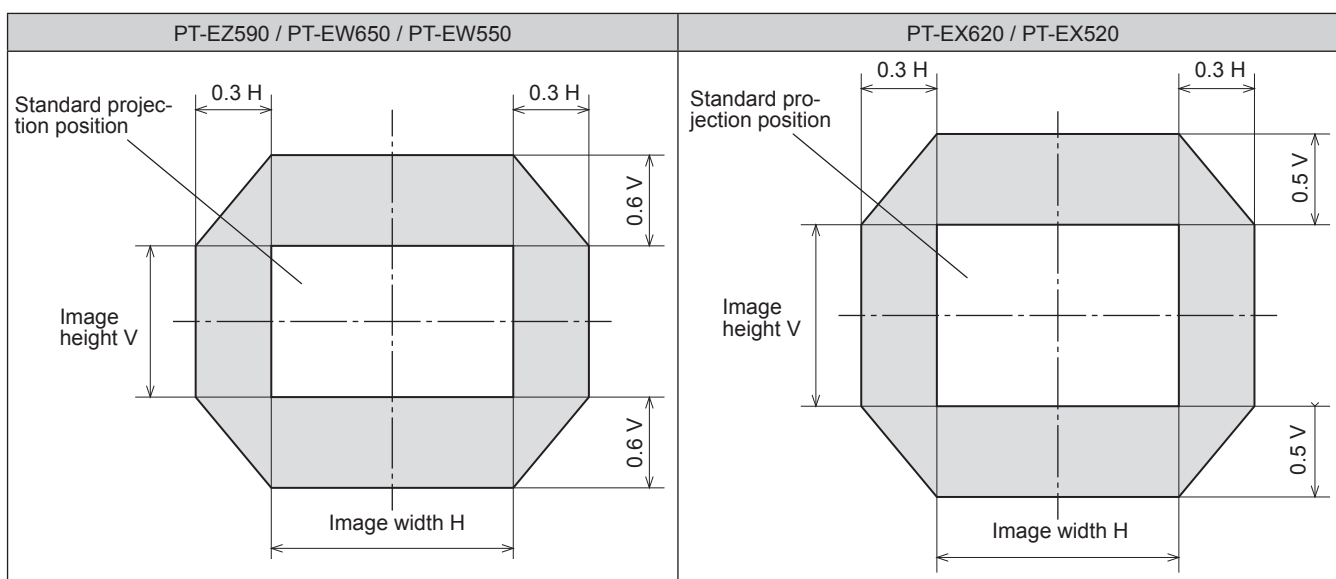

# Operating with the remote control

For PT-EZ590, PT-EW650  
and PT-EX620

For PT-EW550  
and PT-EX520



## Using the shutter/AV mute function

If the projector is not used for a certain period of time during the meeting intermission, for example, it is possible to turn off the image and the audio temporarily.

### ■ Shutter function

(Only for PT-EZ590, PT-EW650 and PT-EX620)



button

- 1) **Press the <SHUTTER> button.**
  - The image and the audio disappear.
  - This operation can be also performed by using the <SHUTTER> button on the control panel.
- 2) **Press the <SHUTTER> button again.**
  - The image and the audio reappear.

### ■ AV mute function

(Only for PT-EW550 and PT-EX520)



button

- 1) **Press the <AV MUTE> button.**
  - The image and the audio disappear.
  - This operation can be also performed by using the <AV MUTE> button on the control panel.
- 2) **Press the <AV MUTE> button again.**
  - The image and the audio reappear.

### Attention

- When the [PROJECTOR SETUP] menu → [ECO MANAGEMENT] → [SHUTTER DETECTION] or [AV MUTE DETECTION] is set to [ON], do not switch on/off in a short time.

### Note

- The power indicator <ON (G)/STANDBY(R)> will blink slowly in green while the shutter function is in use (shutter: closed).
- The shutter function is released by pressing the <RETURN> button while the shutter function is in use (shutter: closed).

## Using the mute function

Audio can be temporarily turned off.



button

- 1) **Press the <MUTE> button.**
  - The audio disappears.
- 2) **Press the <MUTE> button again.**
  - The audio reappears.

## Adjusting the volume

The volume of the built-in speaker or audio output can be adjusted.



- 1) **Press the <VOL-> button/<VOL+> button.**

<VOL->	Decreases the volume.
<VOL+>	Increases the volume.

### Note

- This operation can be also performed by using the <VOL-> button/<VOL+> button on the control panel.

## Using the freeze function

The projected image can be paused and the audio turned off regardless of the playback of the external device.



button

- 1) **Press the <FREEZE> button.**
  - The image freezes and the audio disappears.
- 2) **Press the <FREEZE> button again.**
  - Freezing of the image is canceled and the audio reappears.

### Note

- [FREEZE] is displayed on the screen when video is paused.
- When no signal input, [KEY NOT APPLICABLE] message will appear.

## Using the on-screen display function

Turn off the on-screen display function (no display) when you do not wish the viewers to see the on-screen display, such as the menu or the input terminal name.



button

- 1) **Press the <ON SCREEN> button.**
  - The on-screen display disappears.
- 2) **Press the <ON SCREEN> button again.**
  - The on-screen display appears.



**Note**

- If you press the <MENU> button on the control panel for at least three seconds while the on-screen display is off (hidden), the [OSD] individual adjustment screen is displayed. Press ◀▶ to select [ON], then the on-screen display is turned on.

**Using the automatic setup function**

The automatic setup function can be used to automatically adjust the resolution, clock phase, and image position when analog RGB signals consisting of bitmap images such as computer signals are being input. Supplying images with bright white borders at the edges and high-contrast black and white characters is recommended when the system is in automatic adjustment mode. Avoid supplying images that include halftones or gradation, such as photographs and computer graphics.



- 1) Press the <AUTO SETUP> button.

**Note**

- The clock phase may shift even if it has completed without any incident. In such cases, adjust the [POSITION] menu → [CLOCK PHASE] (➡ page 79).
- Automatic adjustment may not work depending on the model of the computer and the input signal. And, it may not work properly when the input signal is a blurred-edge image or a dark image.
- Images may be disrupted for a few seconds during automatic adjustment, but it is not a malfunction.
- Adjustment is required for each input signal.
- Automatic adjustment can be canceled by pressing the <MENU> button during the automatic adjustment operation.
- If the automatic setup function is used while moving images are being input, the adjustment may not be performed properly even for an RGB signal that can use automatic setup.

**Using the SCREEN ADJ button**

The [SCREEN ADJUSTMENT] screen can be displayed.

You can correct the distortion of the projected image that occurs when the projector is installed tilted or when the screen is tilted or curved.



- 1) Press the <SCREEN ADJ> button to display [KEystone] individual adjustment screen.  
Or press the <SCREEN ADJ> button again to display [CORNER CORRECTION] individual adjustment screen.  
Or press the <SCREEN ADJ> button again to display [CURVED CORRECTION] individual adjustment screen.

- If you have adjusted values in any of the individual adjustment screen, the individual adjustment screen is not switched to the next screen even if you press the <SCREEN ADJ> button.

[KEystone]	Adjusts when the trapezoid of the projected image is distorted.
[CORNER CORRECTION]	Adjusts when the four corners of the projected image are distorted.
[CURVED CORRECTION]	Adjusts when the linearity is not uniform or the projected image is curved distortion.

- 2) Press <ENTER> button to select an item.
  - The items will switch each time you press the button.
- 3) Press ▲▼◀▶ to adjust the value.

**Note**

- One of [KEystone], [CORNER CORRECTION] and [CURVED CORRECTION] setting value is valid.
- For more details, refer to the [POSITION] menu → [SCREEN ADJUSTMENT]. (➡ page 72)

## Switching the aspect ratio of the image

You can switch aspect ratios according to the input signal.



- 1) Press the <ASPECT> button.
  - The setting will change each time you press the button.

### Note

- Refer to the [POSITION] menu → [ASPECT] (➔ page 79) for details.

## Using the digital zoom function

(Only for still image-based RGB signals/still image-based HDMI signals/still image-based DIGITAL LINK signals input)

You can enlarge images. You can also change the location of the images to be enlarged.

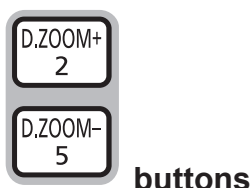

- 1) Press the <D.ZOOM -> button/<D.ZOOM +> button.
  - The moving screen is displayed when executing the remote control operation, and the [DIGITAL ZOOM] individual adjustment screen is not displayed.
  - The [DIGITAL ZOOM] individual adjustment screen is displayed when executing the menu operation. For details, refer to [DISPLAY OPTION] → [OTHER FUNCTIONS]. (➔ page 91)
- 2) Press the following buttons to move the location of the image or adjust the magnification.
  - The digital zoom function is canceled if the <D.ZOOM -> button/<D.ZOOM +> is pressed for three seconds or more.

Operation menu/Buttons	Operation	Adjustment
<p>Moving screen</p> <p>Remote control operation button</p>	Press the ▲ button.	Moves the image to the bottom.
	Press the ▼ button.	Moves the image to the top.
	Press the ◀ button.	Moves the image to the right.
	Press the ▶ button.	Moves the image to the left.
	Press the <MENU> button.	Moves the image to the upper left.
	Press the <RETURN> button.	Moves the image to the upper right.
	Press the <ENTER> button.	Moves the image to the center.
	Press the <DEFAULT> button.	Moves the image to the lower left.
	Press the <FUNCTION> button.	Moves the image to the lower right.
	Press the <D.ZOOM +> button.	Increases magnification.
Press the <D.ZOOM -> button.	Decreases magnification.	

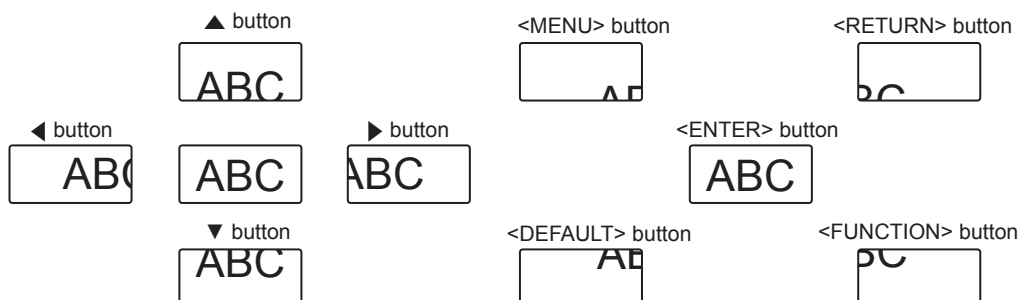

Fig. 1 Screen display position after the button operation

**Note**

- The magnification is not displayed in the moving screen.
- The digital zoom function is canceled if the input signal changes during a digital zoom.
- During a digital zoom, the freeze function is disabled.
- The digital zoom function may not work properly for some still image-based signals.

**Using the presentation timer function**

The presentation timer function can be operated.

Presentations, etc. can be performed while checking the elapsed time or time remaining in the preset time.



**button**

- 1) **Press the <P-TIMER> button.**
  - The count is started.
  - The elapsed time or the remaining time is displayed at the bottom right of the projected image.
- 2) **Press the <P-TIMER> button again.**
  - The count is stopped.
- 3) **Press the <P-TIMER> button again.**
  - The count is resumed.

**Note**

- The presentation timer is ended by holding the <P-TIMER> button down for at least three seconds.
- For details such as presentation timer function settings, refer to [DISPLAY OPTION] menu → [P-TIMER] (➡ page 91).

**Using the FUNCTION button**

Some operations in the menu can be assigned to the <FUNCTION> button on the remote control so that it can be used as an easy shortcut button.



**button**

- 1) **Press the <FUNCTION> button.**

**To assign functions to the <FUNCTION> button**

- 1) **Press the <MENU> button on the control panel or the remote control to display the menu items (main menu, sub menu, or details menu) you want to assign.**
  - Refer to “Navigating through the menu” (➡ page 63) for the operation of the on-screen menu.
- 2) **Press and hold the <FUNCTION> button for three seconds or more.**

**Note**

- After settings have been completed, the assigned menu item (main menu, sub-menu, or details menu) will be displayed in [ASSIGNED FUNCTION] of the operation guide under the menu.
- Assignment of the function is performed from the [PROJECTOR SETUP] menu → [FUNCTION BUTTON] (➡ page 97) when deallocating functions.

**Displaying internal test patterns**

The projector has ten types of internal test patterns to check the condition of the projector. To display test patterns, perform the following steps.



**button**

- 1) **Press the <TEST PATTERN> button.**

2) Press ◀▶ to select the test pattern.

### Note

- Setting is also available from the [TEST PATTERN] (➔ page 100) menu.
- Settings of position, size, and other factors will not be reflected in test patterns. Make sure to display the input signal before performing various adjustments.

## Using the status function

You can display the status of the projector.



button

1) Press the <STATUS> button.

- The [STATUS] screen is displayed.

PT-E2590	STATUS
PICTURE	SIGNAL
	NAME MUXGA60-RB
POSITION	FREQUENCY 74.28kHz/ 60.10kHz
LANGUAGE	STARTING
	PROJECTOR 12 H
DISPLAY OPTION	LAMP ECO 4 H
	(ET-LAET100) NORMAL 7 H
PROJECTOR SETUP	
SECURITY	SERIAL NUMBER
	PROJECTOR 001224567
NETWORK	
	RETURN ASSIGNED FUNCTION: DISABLE

### Note

- This can be displayed from the [PROJECTOR SETUP] menu → [STATUS] (➔ page 93).

## Using the ECO management function

You can display the setting screen relating to ECO management.



button

1) Press the <ECO> button.

### Note

- Refer to the [PROJECTOR SETUP] menu → [ECO MANAGEMENT] (➔ page 94) for details.

## Setting the ID number of the remote control

---

When you use the system with multiple projectors, you can operate all the projectors simultaneously or each projector individually by using single remote control, if unique ID number is assigned to each projector.

After setting the ID number of the projector, set the same ID number to the remote control.

**The factory default ID number of the projector is set to [ALL]. When using a single projector, press the <ID ALL> button on the remote control. Also, you can control a projector by pressing the <ID ALL> button on the remote control even if you do not know the projector ID.**



- 1) Press the <ID SET> button.
- 2) **Within five seconds, press and set the one-digit or two-digit ID number set on the projector using the number (<0> - <9>) buttons.**
  - If you press the <ID ALL> button, you can control the projectors regardless of the ID number setting of the projector.

---

### Attention

---

- Since the ID number of the remote control can be set without the projector, do not press the <ID SET> button on the remote control carelessly. If the <ID SET> button is pressed and no number (<0> - <9>) buttons are pressed within five seconds, the ID number returns to its original value before the <ID SET> button was pressed.
- The ID number set on the remote control will be stored unless it is set again. However, it will be erased if the remote control is left with dead batteries. Set the same ID number again when the batteries are replaced.

---

### Note

---

- Set the ID number of the projector from the [PROJECTOR SETUP] menu → [PROJECTOR ID]. (➡ page 93)

# Chapter 4 **Settings**

---

This chapter describes the settings and the adjustments you can make using the on-screen menu.

# Menu navigation

The on-screen menu (Menu) is used to perform various settings and adjustments of the projector.

## Navigating through the menu

### Operating procedure



button

- 1) Press the <MENU> button on the remote control or the control panel.
  - The main menu screen appears.



- 2) Press ▲▼ to select an item from the main menu.
  - The selected item is highlighted in yellow.



- 3) Press the <ENTER> button.
  - The sub-menu items of the selected main menu are displayed.



- 4) Press ▲▼ to select a sub-menu, and press ◀▶ or the <ENTER> button to change or adjust settings.
  - Some items will switch in order as follows each time you press ◀▶.

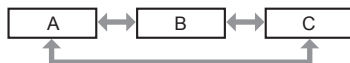

- For some items, press ◀▶ to display an individual adjustment screen with a bar scale as shown below.



### Note

- Pressing the <MENU> button while the menu screen is displayed to return the previous menu. You can operate in the same way by pressing the <RETURN> button.
- Some items may not be adjusted or used for certain signal formats to be input to the projector. The menu items that cannot be adjusted or used are shown in gray characters, and they cannot be selected. [DIGITAL CINEMA REALITY] and [FRAME LOCK] may not be displayed depending on the input signal.
- Some items can be adjusted even if signals are not input.
- Individual adjustment screen is cleared automatically if no operation is performed for approximately five seconds.
- For menu items, refer to "Main menu" (➔ page 64) and "Sub menu" (➔ page 64).

### Resetting adjustment values to the factory default

If the <DEFAULT> button on the remote control is pressed, the values adjusted in the menu items are restored to the factory default settings.



**button**

- 1) Press the <DEFAULT> button on the remote control.







### Note

- You cannot reset all the settings to the factory default at a time.
- To reset all the settings adjusted in the sub-menu item to the factory default at a time, execute the [PROJECTOR SETUP] menu → [INITIALIZE ALL]. (➔ page 104)
- Some items cannot be reset by pressing the <DEFAULT> button. Adjust each item manually.

### Main menu

The following items are in the main menu.

When a main menu item is selected, the screen changes to a sub-menu selection screen.

	Main menu item	Page
	[PICTURE]	67
	[POSITION]	72
	[LANGUAGE]	81
	[DISPLAY OPTION]	82
	[PROJECTOR SETUP]	93
	[SECURITY]	105
	[NETWORK]	108

### Sub-menu

The sub-menu of the selected main menu item is displayed, and you can set and adjust items in the sub-menu.



**[PICTURE]** 

Sub-menu item	Factory default	Page
[PICTURE MODE]	[STANDARD]	67
[CONTRAST]	[0]	67
[BRIGHTNESS]	[0]	67
[COLOR]*2	[0]	68
[TINT]*2	[0]	68
[SHARPNESS]	[+8]	68
[COLOR TEMPERATURE]	[DEFAULT]	68
[GAMMA]	[0]	69
[IRIS]*3	[OFF]*1	69
[ADVANCED MENU]	-	69
[DAYLIGHT VIEW]	[AUTO]*1*4	70
[DIGITAL CINEMA REALITY]*2	[ON]	70
[NOISE REDUCTION]*5	[1]	70
[TV-SYSTEM]*5	[AUTO]	71
[RGB/Y <sub>B</sub> P <sub>R</sub> ]/[RGB/Y <sub>B</sub> C <sub>R</sub> ]*6	[AUTO]	71

\*1 Depends on the [PICTURE MODE].

\*2 Only for movie-based signals

\*3 Only for PT-EZ590, PT-EW650 and PT-EX620

\*4 Depends on the [PROJECTION METHOD].

\*5 Only when the <VIDEO IN> terminal is selected

\*6 Only when the <RGB 1 IN> terminal/<RGB 2 IN> terminal/<HDMI 1 IN> terminal/<HDMI 2 IN> terminal/<DIGITAL LINK/LAN> terminal is selected

**Note**

- The factory default settings may vary depending on the picture mode.

**[POSITION]** 

Sub-menu item	Factory default	Page
[REALTIME KEYSTONE]	[OFF]	72
[SCREEN ADJUSTMENT]	-	72
[SHIFT]	-	78
[DOT CLOCK]*1	[0]	78
[CLOCK PHASE]*1	[0]	79
[OVER SCAN]	-	79
[ASPECT]	[NORMAL]*2	79
[FRAME LOCK]*1	[ON]	80
[CLAMP POSITION]	[24]*2	80

\*1 Only for still image signals

\*2 Depends on the signal input.

**[LANGUAGE]** 

Details (➔ page 81)

**[DISPLAY OPTION]** 

Sub-menu item	Factory default	Page
[ON-SCREEN DISPLAY]	-	82
[RGB IN]	-	83
[HDMI IN]	-	84
[DIGITAL LINK IN]*1	-	85
[CLOSED CAPTION SETTING]	-	86
[SCREEN SETTING]	-	87
[STARTUP LOGO]	[DEFAULT LOGO]	88
[SHUTTER SETTING]*1	-	88
[AUTO SETUP SETTING]	[AUTO]	89
[SIGNAL SEARCH]	[ON]	89
[STARTUP INPUT SELECT]	[LAST USED]	89

Sub-menu item	Factory default	Page
[BACK COLOR]	[BLUE]	90
[WIDE MODE]	[AUTO]	90
[\$XGA MODE]	[AUTO]	90
[P-TIMER]	-	90
[OTHER FUNCTIONS]	-	91

\*1 Only for PT-EZ590, PT-EW650 and PT-EX620

## [PROJECTOR SETUP]

Sub-menu item	Factory default	Page
[STATUS]	-	93
[PROJECTOR ID]	[ALL]	93
[INITIAL START UP]	[LAST MEMORY]	93
[PROJECTION METHOD]	[AUTO]	94
[LAMP POWER]	[NORMAL]	94
[ECO MANAGEMENT]	-	94
[RS-232C]	-	96
[REMOTE1 MODE]	[DEFAULT]	97
[FUNCTION BUTTON]	-	97
[AUDIO SETTING]	-	98
[TEST PATTERN]	-	100
[FILTER COUNTER]	-	100
[SCHEDULE]	[OFF]	101
[DATE AND TIME]	-	103
[LENS CALIBRATION]	-	103
[INITIALIZE ALL]	-	104
[SERVICE PASSWORD]	-	104

## [SECURITY]

Sub-menu item	Factory Default	Page
[PASSWORD]	[OFF]	105
[PASSWORD CHANGE]	-	105
[DISPLAY SETTING]	[OFF]	105
[TEXT CHANGE]	-	106
[MENU LOCK]	[OFF]	106
[MENU LOCK PASSWORD]	-	106
[CONTROL DEVICE SETUP]	-	106

## [NETWORK]

Sub-menu item	Factory default	Page
[DIGITAL LINK MODE] <sup>*1</sup>	[AUTO]	108
[DIGITAL LINK STATUS] <sup>*1</sup>	-	108
[DIGITAL LINK MENU] <sup>*1</sup>	-	109
[WIRED LAN]	-	109
[PROJECTOR NAME]	[Name 1234] <sup>*2</sup>	109
[NETWORK CONTROL]	-	110
[NETWORK STATUS]	-	110
[INITIALIZE]	-	111

\*1 Only for PT-EZ590, PT-EW650 and PT-EX620

\*2 It will be different for each product.

### Note

- Some items may not be adjusted or used for certain signal formats to be input to the projector.  
The menu items that cannot be adjusted or used are shown in gray characters, and they cannot be selected.
- Sub-menu items and factory default settings vary depending on the selected input terminal.

## [PICTURE] menu

On the menu screen, select [PICTURE] from the main menu, and select an item from the sub-menu. Refer to “Navigating through the menu” (➔ page 63) for the operation of the menu screen.

### [PICTURE MODE]

You can switch to the desired picture mode suitable for the image source and the environment in which the projector is used.

- 1) Press ▲▼ to select [PICTURE MODE].
- 2) Press ◀▶ or the <ENTER> button.
  - The [PICTURE MODE] individual adjustment screen is displayed.
- 3) Press ◀▶ to switch the item.
  - The items will switch each time you press the button.

[STANDARD]	The image becomes suitable for moving images in general.
[DYNAMIC]	The light output is maximized for use in bright areas.
[DICOM SIM.]	The image becomes similar to that of DICOM Part 14 Grayscale Standard.
[BLACKBOARD]	The image becomes suitable for projecting on a blackboard.
[WHITE BOARD]	The image becomes suitable for projecting on a white board.
[CINEMA] <sup>*1</sup>	The image becomes suitable for movie contents.
[NATURAL] <sup>*2</sup>	The image becomes suitable for using in low-light areas.

\*1 Only for movie-based input signals

\*2 Only for still image input signals

#### Note

- DICOM is an abbreviation of “Digital Imaging and COmmunication in Medicine” and is a standard for medical imaging devices. Although the DICOM name is used, the projector is not a medical device, and should not be used for purposes such as diagnosis of display images.
- When [PICTURE MODE] is set to [DICOM SIM.], the [DAYLIGHT VIEW] is fixed to [OFF].
- When [PICTURE MODE] is set to [DICOM SIM.], the [LAMP POWER] in the [PROJECTOR SETUP] menu is fixed to [ECO].

### [CONTRAST]

You can adjust the contrast of the colors.

- 1) Press ▲▼ to select [CONTRAST].
- 2) Press ◀▶ or the <ENTER> button.
  - The [CONTRAST] individual adjustment screen is displayed.
- 3) Press ◀▶ to adjust the level.

Operation	Adjustment	Range of adjustment
Press the ▶ button.	Brightens the screen and makes the color of image deeper.	-32 ~ +32
Press the ◀ button.	Darkens the screen and makes the color of image lighter.	

#### Attention

- Adjust [BRIGHTNESS] first when you need to adjust [BRIGHTNESS] and [CONTRAST].

### [BRIGHTNESS]

You can adjust the dark (black) part of the projected image.

- 1) Press ▲▼ to select [BRIGHTNESS].
- 2) Press ◀▶ or the <ENTER> button.
  - The [BRIGHTNESS] individual adjustment screen is displayed.
- 3) Press ◀▶ to adjust the level.

Operation	Adjustment	Range of adjustment
Press the ► button.	Increases the brightness of the dark (black) parts of the screen.	-32 ~ +32
Press the ◀ button.	Reduces the brightness of the dark (black) parts of the screen.	

## [COLOR]

(Only for movie-based signal input)

You can adjust the color saturation of the projected image.

- 1) Press ▲▼ to select [COLOR].
- 2) Press ◀▶ or the <ENTER> button.
  - The [COLOR] individual adjustment screen is displayed.
- 3) Press ◀▶ to adjust the level.

Operation	Adjustment	Range of adjustment
Press the ► button.	Deepens colors.	-32 ~ +32
Press the ◀ button.	Weakens colors.	

## [TINT]

(Only for NTSC/NTSC4.43 signal when input movie-based signal and the <VIDEO IN> terminal or the <RGB 1 IN><sup>\*1</sup> terminal is selected)

You can adjust the skin tone in the projected image.

- 1) Press ▲▼ to select [TINT].
- 2) Press ◀▶ or the <ENTER> button.
  - The [TINT] individual adjustment screen is displayed.
- 3) Press ◀▶ to adjust the level.

Operation	Adjustment	Range of adjustment
Press the ► button.	Adjusts skin tone toward greenish color.	-32 ~ +32
Press the ◀ button.	Adjusts skin tone toward reddish purple.	

\*1 When [RGB1 INPUT SETTING] is set to [Y/C] (➔page 83)

## [SHARPNESS]

You can adjust the sharpness of the projected image.

- 1) Press ▲▼ to select [SHARPNESS].
- 2) Press ◀▶ or the <ENTER> button.
  - The [SHARPNESS] individual adjustment screen is displayed.
- 3) Press ◀▶ to adjust the level.

Operation	Adjustment	Range of adjustment
Press the ► button.	Contours become sharper.	0 ~ +15
Press the ◀ button.	Contours become softer.	

### Note

- [SHARPNESS] will be invalid when [DAYLIGHT VIEW] is set to [AUTO]/[1]/[2]/[3].

## [COLOR TEMPERATURE]

You can switch the color temperature if the white areas of the projected image are bluish or reddish.

- 1) Press ▲▼ to select [COLOR TEMPERATURE].
- 2) Press ◀▶ or the <ENTER> button.
  - The [COLOR TEMPERATURE] individual adjustment screen is displayed.

- 3) Press ◀▶ to switch the item.
- The items will switch each time you press the button.

[DEFAULT]	Factory default setting.
[HIGH]	Select so that images become natural.
[LOW]	

## [GAMMA]

You can adjust contrast balance.

- Press ▲▼ to select [GAMMA].
- Press ◀▶ or the <ENTER> button.
  - The [GAMMA] individual adjustment screen is displayed.
- Press ◀▶ to adjust the level.

Operation	Adjustment	Range of adjustment
Press the ▶ button.	The midtones become brighter.	-8 ~ +7
Press the ◀ button.	The midtones become darker.	

## [IRIS]

(Only for PT-EZ590, PT-EW650 and PT-EX620)

Aperture correction is performed automatically based on the image to result in an image of optimum contrast.

- Press ▲▼ to select [IRIS].
- Press ◀▶ or the <ENTER> button.
  - The [IRIS] individual adjustment screen is displayed.
- Press ◀▶ to switch the item.
  - The items will switch each time you press the button.

[OFF]	No correction.
[ON]	Automatically corrects the aperture.

## [ADVANCED MENU]

You can perform more advanced image adjustment.

- Press ▲▼ to select [ADVANCED MENU].
- Press the <ENTER> button.
  - The [ADVANCED MENU] screen is displayed.
- Press ▲▼ to select one item among [CONTRAST R] ~ [BRIGHTNESS B].
- Press ◀▶ or the <ENTER> button.
  - The individual adjustment screen of items are displayed.
- Press ◀▶ to adjust the value.

Items	Operation	Adjustment	Adjustment range
[CONTRAST R]	Press the ▶ button.	Emphasizes red in highlight areas.	-32 ~ +32
	Press the ◀ button.	Deemphasizes red in highlight areas.	
[CONTRAST G]	Press the ▶ button.	Emphasizes green in highlight areas.	-32 ~ +32
	Press the ◀ button.	Deemphasizes green in highlight areas.	
[CONTRAST B]	Press the ▶ button.	Emphasizes blue in highlight areas.	-32 ~ +32
	Press the ◀ button.	Deemphasizes blue in highlight areas.	
[BRIGHTNESS R]	Press the ▶ button.	Emphasizes red in shadow areas.	-32 ~ +32
	Press the ◀ button.	Deemphasizes red in shadow areas.	

Items	Operation	Adjustment	Adjustment range
[BRIGHTNESS G]	Press the ► button.	Emphasizes green in shadow areas.	-32 ~ +32
	Press the ◀ button.	Deemphasizes green in shadow areas.	
[BRIGHTNESS B]	Press the ► button.	Emphasizes blue in shadow areas.	-32 ~ +32
	Press the ◀ button.	Deemphasizes blue in shadow areas.	

## [DAYLIGHT VIEW]

You can correct the image to the optimal vividness even if it is projected under a bright light.

- 1) Press ▲▼ to select [DAYLIGHT VIEW].
- 2) Press ◀▶ or the <ENTER> button.
  - The [DAYLIGHT VIEW] individual adjustment screen is displayed.
- 3) Press ◀▶ to switch the item.
  - The items will switch each time you press the button.

[AUTO]	The brightness of the installation environment is detected by the luminance sensor, and the vividness of the image is automatically corrected.
[OFF]	No correction.
[1]	Corrects the image to weaken vividness.
[2]	Corrects the image to medium vividness.
[3]	Corrects the image to high vividness.

### Note

- When [PROJECTION METHOD] (▶ page 94) is set to [REAR/DESK] or [REAR/CEILING], [AUTO] cannot be selected.
- When objects, etc. are placed on the top of the projector, the illuminance sensor enters the shadow and the [AUTO] mode may not function properly.
- When [PICTURE MODE] is set to [DICOM SIM.], the factory default setting of the [DAYLIGHT VIEW] is [OFF] and the setting values in the menu screen display in gray.
- When [DAYLIGHT VIEW] is set to [AUTO], [1], [2] or [3], the [SHARPNESS] cannot be adjusted.

## [DIGITAL CINEMA REALITY]

You can increase the vertical resolution and enhance the image quality by performing cinema processing when the PAL (or SECAM) 576i signal, the NTSC 480i signal, and 1080/50i, 1080/60i are input.

- 1) Press ▲▼ to select [DIGITAL CINEMA REALITY].
- 2) Press ◀▶ or the <ENTER> button.
  - The [DIGITAL CINEMA REALITY] individual adjustment screen is displayed.
- 3) Press ◀▶ to switch the item.
  - The items will switch each time you press the button.

[ON]	Performs cinema processing.
[OFF]	Does not perform cinema processing.

## [NOISE REDUCTION]

(Only when the <VIDEO IN> terminal or <RGB 1 IN><sup>\*1</sup> terminal is selected)

You can reduce noises when the input image is degraded and noise is occurring in the image signal.

- 1) Press ▲▼ to select [NOISE REDUCTION].
- 2) Press ◀▶ or the <ENTER> button.
  - The [NOISE REDUCTION] individual adjustment screen is displayed.
- 3) Press ◀▶ to switch the item.
  - The items will switch each time you press the button.

[OFF]	No correction.
[1]	Slightly corrects the noise.
[2]	Moderately corrects the noise.
[3]	Strongly corrects the noise.

\*1 When [RGB1 INPUT SETTING] is set to [Y/C] (➔ page 83)

**Attention**

- When this is set for an input signal with less noise, the image may look different from what it originally was. In such a case, set it to [OFF].

**[TV-SYSTEM]**

(Only when the <VIDEO IN> terminal or <RGB 1 IN>\*1 terminal is selected)

The projector will automatically detect the input signal, but you can set the color system manually when an unstable signal is input. Set the color system to match the input signal.

\*1 When [RGB1 INPUT SETTING] is set to [Y/C] (➔ page 83)

- 1) Press ▲▼ to select [TV-SYSTEM].
- 2) Press ◀▶ or the <ENTER> button.
  - The [TV-SYSTEM] individual adjustment screen is displayed.
- 3) Press ◀▶ to select the color system.
  - The items will switch each time you press the button.
  - Select among [AUTO], [NTSC], [NTSC4.43], [PAL], [PAL-M], [PAL-N], [PAL60] and [SECAM].
  - Set it to [AUTO] normally. (Setting [AUTO] will automatically select [NTSC], [NTSC4.43], [PAL], [PAL-M], [PAL-N], [SECAM], or [PAL60].)

**[RGB/YP<sub>B</sub>P<sub>R</sub>]/[RGB/YC<sub>B</sub>C<sub>R</sub>]**

Set it to [AUTO] normally. If images are not displayed correctly when this is set to [AUTO], set either [RGB], [YC<sub>B</sub>C<sub>R</sub>] or [YP<sub>B</sub>P<sub>R</sub>] in accordance with the input signal.

- 1) Press ▲▼ to select [RGB/YP<sub>B</sub>P<sub>R</sub>] or [RGB/YC<sub>B</sub>C<sub>R</sub>].
- 2) Press ◀▶ or the <ENTER> button.
  - The [RGB/YP<sub>B</sub>P<sub>R</sub>] or [RGB/YC<sub>B</sub>C<sub>R</sub>] individual adjustment screen is displayed.
- 3) Press ◀▶ to switch the item.
  - The items will switch each time you press the button.

[AUTO]	The sync signal automatically selects the signal [RGB]/[YP <sub>B</sub> P <sub>R</sub> ]/[YC <sub>B</sub> C <sub>R</sub> ].
[RGB]	Select it for RGB signal input.
[YP <sub>B</sub> P <sub>R</sub> ]	Select it for YP <sub>B</sub> P <sub>R</sub> signal input.
[YC <sub>B</sub> C <sub>R</sub> ]	Select it for YC <sub>B</sub> C <sub>R</sub> signal input.

**When the <RGB 1 IN>/<RGB 2 IN> terminal is selected**

- For 525(480)/60i, 625(576)/50i, 525(480)/60p and 625(576)/50p input  
Select [AUTO], [RGB] or [YC<sub>B</sub>C<sub>R</sub>].
- For other movie-based signal input  
Select [AUTO], [RGB] or [YP<sub>B</sub>P<sub>R</sub>].

**When the <HDMI 1 IN>/<HDMI 2 IN>/<DIGITAL LINK>\*1 terminal is selected**

- For 525(480)/60i, 625(576)/50i, 525(480)/60p and 625(576)/50p input  
Select [AUTO], [RGB] or [YC<sub>B</sub>C<sub>R</sub>].
- For other movie-based signal input  
Select [AUTO], [RGB] or [YP<sub>B</sub>P<sub>R</sub>].

\*1 Only for PT-EZ590, PT-EW650 and PT-EX620

**Note**

- Refer to “List of compatible signals” (➔ page 157) for the types of video signals that can be used with the projector.
- The signal selection may not function properly depending on connected devices.

## [POSITION] menu

On the menu screen, select [POSITION] from the main menu, and select an item from the sub-menu. Refer to “Navigating through the menu” (➔ page 63) for the operation of the menu screen.

### [REALTIME KEYSTONE]

The projector can correct the distortion of the projected image automatically when the projector is installed tilted.

- 1) Press ▲▼ to select [REALTIME KEYSTONE].
- 2) Press ◀▶ or the <ENTER> button.
  - The [REALTIME KEYSTONE] individual adjustment screen is displayed.
- 3) Press ◀▶ to switch the item.
  - The items will switch each time you press the button.

[OFF]	Does not execute the realtime keystone function automatically.
[ON]	Executes the realtime keystone function automatically.

#### Note

- Sometimes the realtime keystone function may not correct the image properly, the operation of the [SCREEN ADJUSTMENT] is required.
- The [REALTIME KEYSTONE] function cannot work when the [FRONT/CEILING] or the [REAR/CEILING] feature is selected in [PROJECTION METHOD] in the [PROJECTOR SETUP] menu.

### [SCREEN ADJUSTMENT] (For PT-EZ590)

You can correct the distortion of the projected image that occurs when the projector is installed tilted or when the screen is tilted or curved.

- 1) Press ▲▼ to select [SCREEN ADJUSTMENT].
- 2) Press the <ENTER> button.
  - The [SCREEN ADJUSTMENT] screen is displayed.
- 3) Press ▲▼ to select one item to adjust.

[KEYSTONE]	Adjusts when the trapezoid of the projected image is distorted.
[CORNER CORRECTION]	Adjusts when the four corners of the projected image are distorted.
[CURVED CORRECTION]	Adjusts when the linearity is not uniform or the projected image is curved distortion.

#### Setting [KEYSTONE]

- 1) Press ▲▼ to select [SCREEN ADJUSTMENT].
- 2) Press the <ENTER> button.
  - The [SCREEN ADJUSTMENT] screen is displayed.
- 3) Press ▲▼ to select [KEYSTONE].
- 4) Press the <ENTER> button.
  - The [KEYSTONE] individual adjustment screen is displayed.
- 5) Press ▲▼ to select one item to adjust.

[LENS THROW RATIO]	Set the throw ratio for the lens used.
[KEYSTONE]	Adjusts when the trapezoid of the projected image is distorted.
[BALANCE]	Adjusts according to the lens shift range in the horizontal or vertical direction.



**Adjusting [LENS THROW RATIO]**

- 1) Press ▲▼ to select [SCREEN ADJUSTMENT].
- 2) Press the <ENTER> button.
  - The [SCREEN ADJUSTMENT] screen is displayed.
- 3) Press ▲▼ to select [KEYSTONE].
- 4) Press the <ENTER> button.
  - The [KEYSTONE] screen is displayed.
- 5) Press ▲▼ to select [LENS THROW RATIO].
- 6) Press the <ENTER> button.
  - The [LENS THROW RATIO] individual adjustment screen is displayed.
- 7) Press ◀▶ to adjust the item.
  - The adjustment values are [0.5] to [10.5].

**Adjusting [KEYSTONE]**

- 1) Press ▲▼ to select [SCREEN ADJUSTMENT].
- 2) Press the <ENTER> button.
  - The [SCREEN ADJUSTMENT] screen is displayed.
- 3) Press ▲▼ to select [KEYSTONE].
- 4) Press the <ENTER> button.
  - The [KEYSTONE] screen is displayed.
- 5) Press ▲▼ to select [KEYSTONE].
- 6) Press the <ENTER> button.
  - The [KEYSTONE] individual adjustment screen is displayed.
- 7) Press ▲▼◀▶ to adjust the item.

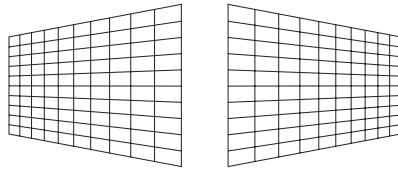
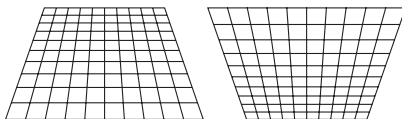
Items	Operation	Adjustment	
[H]	Press the ◀ button.	Left side will be smaller.	
	Press the ▶ button.	Right side will be smaller.	
[V]	Press the ▲ button.	Upper will be smaller.	
	Press the ▼ button.	Lower will be smaller.	

**Adjusting [BALANCE]**

- 1) Press ▲▼ to select [SCREEN ADJUSTMENT].
- 2) Press the <ENTER> button.
  - The [SCREEN ADJUSTMENT] screen is displayed.

- 3) Press ▲▼ to select [KEystone].
- 4) Press the <ENTER> button.
  - The [KEystone] screen is displayed.
- 5) Press ▲▼ to select [BALANCE].
- 6) Press the <ENTER> button.
  - The [BALANCE] individual adjustment screen is displayed.
- 7) Press ▲▼◀▶ to adjust the balance.

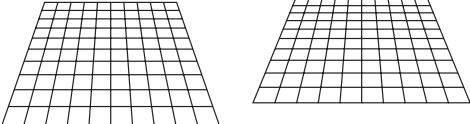
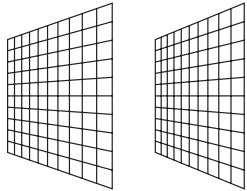
Adjustment	
<p><b>[VERTICAL BALANCE]</b></p> <div style="text-align: center;">  </div> <p>Adjust the setting according to the lens shift range in the vertical direction.</p>	<p><b>[HORIZONTAL BALANCE]</b></p> <div style="text-align: center;">  </div> <p>Adjust the setting according to the lens shift range in the horizontal direction.</p>

### Setting [CORNER CORRECTION]

- 1) Press ▲▼ to select [SCREEN ADJUSTMENT].
- 2) Press the <ENTER> button.
  - The [SCREEN ADJUSTMENT] screen is displayed.
- 3) Press ▲▼ to select [CORNER CORRECTION].
- 4) Press the <ENTER> button.
  - The [CORNER CORRECTION] screen is displayed.
- 5) Press ▲▼ to select the item to adjust, then press the <ENTER> button.
  - The [CORNER CORRECTION] individual adjustment screen is displayed.
- 6) Press ▲▼◀▶ to adjust.

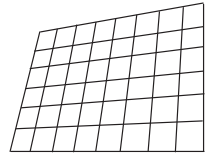
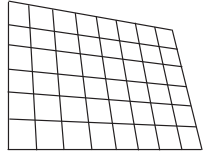
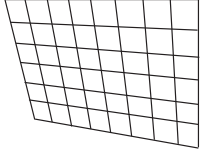
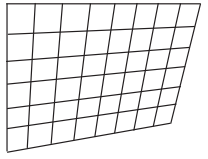
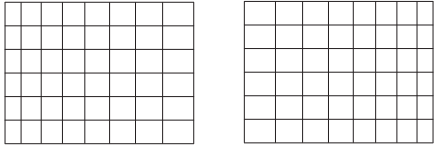
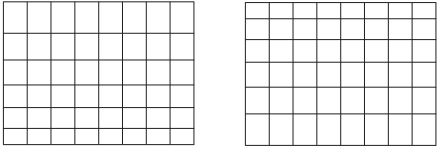
[CORNER CORRECTION]			
<p><b>[UPPER LEFT]</b></p> <div style="text-align: center;">  </div>	<p><b>[UPPER RIGHT]</b></p> <div style="text-align: center;">  </div>	<p><b>[LOWER LEFT]</b></p> <div style="text-align: center;">  </div>	<p><b>[LOWER RIGHT]</b></p> <div style="text-align: center;">  </div>
<p><b>[LINEARITY]</b> Horizontal direction</p> <div style="text-align: center;">  </div>	<p><b>[LINEARITY]</b> Vertical direction</p> <div style="text-align: center;">  </div>		

### Setting [CURVED CORRECTION]

- 1) Press ▲▼ to select [SCREEN ADJUSTMENT].
- 2) Press the <ENTER> button.

- The [SCREEN ADJUSTMENT] screen is displayed.

3) Press ▲▼ to select [CURVED CORRECTION].

4) Press the <ENTER> button.

- The [CURVED CORRECTION] screen is displayed.

5) Press ▲▼ to select one item to adjust.

[LENS THROW RATIO]	Adjusts when the throw ratio of projector lens is changed.
[KEystone]	Adjusts when the trapezoid of the projected image is distorted.
[ARC]	Adjusts when the radian of the projected image is distorted.
[BALANCE]	Adjusts according to the lens shift range in the horizontal or vertical direction.
[MAINTAIN ASPECT RATIO]	Set to [ON], maintain the aspect ratio when correct the curved distortion of the projected image.

6) Press the <ENTER> button.

- The individual adjustment screen of the selected function is displayed.

### Adjusting [LENS THROW RATIO]

1) Press ◀▶ to adjust.

- For details, please refer to “Setting [KEYSTONE]” → “Adjusting [LENS THROW RATIO]” (➡ page 73).



### Adjusting [KEYSTONE]

1) Press ▲▼◀▶ to adjust.

- For details, please refer to “Setting [KEYSTONE]” → “Adjusting [KEYSTONE]” (➡ page 73).

### Adjusting [ARC]

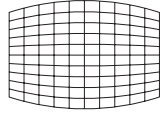
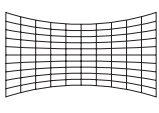
1) Press ▲▼◀▶ to adjust.

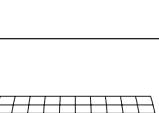
Items	Operation	Adjustment		
[H]	Press the ◀ button.	The top and the bottom of horizontal line will be bulge.		
	Press the ▶ button.	The top and the bottom of horizontal line will be dent.		
[V]	Press the ▲ button.	The left and the right of vertical line will be dent.		
	Press the ▼ button.	The left and the right of vertical line will be bulge.		

### Adjusting [BALANCE]

1) Press ◀▶ to adjust.

- For details, please refer to “Setting [KEYSTONE]” → “Adjusting [BALANCE]” (➡ page 73).

#### Note

- One of [KEYSTONE], [CORNER CORRECTION] and [CURVED CORRECTION] setting value is valid. When [KEYSTONE], [CORNER CORRECTION] or [CURVED CORRECTION] adjustment is finished, you adjust the others, the adjusted value will be reset.
- Press the <SCREEN ADJ> button on the remote control when the [KEYSTONE], [CORNER CORRECTION] or [CURVED CORRECTION] screen is displaying, it will switch to the next adjustment screen.
- When the [CORNER CORRECTION] individual adjustment screen is displaying, the individual adjustment screen of the next corner can also be displayed by pressing the <ENTER> button.

- Correcting up to  $\pm 25^\circ$  for the tilt in the vertical direction and  $\pm 30^\circ$  for the tilt in the horizontal direction are available for adjustments with [KEYSTONE]. However, the image quality will degrade and it will get harder to focus with more correction. Install the projector so that the correction will be as small as possible.
- Screen size will also change when [KEYSTONE] is used to perform various adjustments.
- Aspect ratio of the image size may shift depending on the correction.

### [SCREEN ADJUSTMENT] (For PT-EW650, PT-EW550, PT-EX620 and PT-EX520)

You can correct the distortion of the projected image that occurs when the projector is installed tilted or when the screen is tilted or curved.

- 1) Press **▲▼** to select [SCREEN ADJUSTMENT].
- 2) Press the **<ENTER>** button.
  - The [SCREEN ADJUSTMENT] screen is displayed.
- 3) Press **▲▼** to select one item to adjust.

[KEYSTONE]	Adjusts when the trapezoid of the projected image is distorted.
[CORNER CORRECTION]	Adjusts when the four corners of the projected image are distorted.
[CURVED CORRECTION]	Adjusts when the linearity is not uniform or the projected image is curved distortion.

#### Setting [KEYSTONE]

- 1) Press **▲▼** to select [SCREEN ADJUSTMENT].
- 2) Press the **<ENTER>** button.
  - The [SCREEN ADJUSTMENT] screen is displayed.
- 3) Press **▲▼** to select [KEYSTONE].
- 4) Press the **<ENTER>** button.
  - The [KEYSTONE] individual adjustment screen is displayed.
- 5) Press **▲▼◀▶** to adjust the item.

Items	Operation	Adjustment
[H]	Press the <b>◀</b> button.	Left side will be smaller.
	Press the <b>▶</b> button.	Right side will be smaller.
[V]	Press the <b>▲</b> button.	Upper will be smaller.
	Press the <b>▼</b> button.	Lower will be smaller.

#### Setting [CORNER CORRECTION]

- 1) Press **▲▼** to select [SCREEN ADJUSTMENT].
- 2) Press the **<ENTER>** button.
  - The [SCREEN ADJUSTMENT] screen is displayed.
- 3) Press **▲▼** to select [CORNER CORRECTION].
- 4) Press the **<ENTER>** button.
  - The [CORNER CORRECTION] screen is displayed.

- 5) Press ▲▼ to select the item to adjust, then press the <ENTER> button.
  - The [CORNER CORRECTION] individual adjustment screen is displayed.
- 6) Press ▲▼◀▶ to adjust.

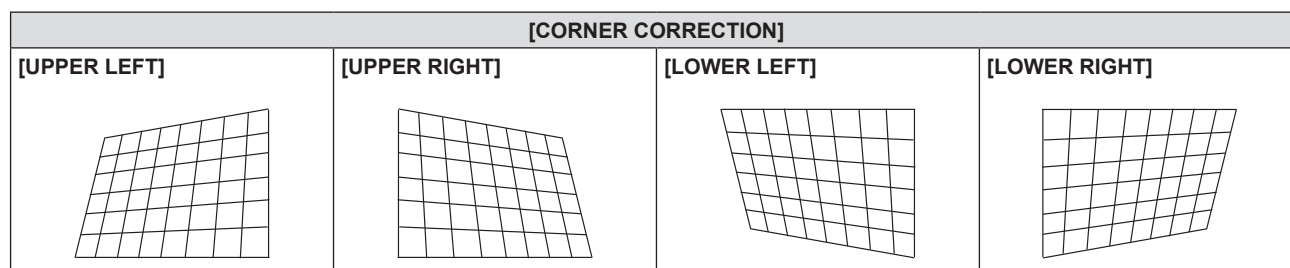

### Setting [CURVED CORRECTION]

- 1) Press ▲▼ to select [SCREEN ADJUSTMENT].
- 2) Press the <ENTER> button.
  - The [SCREEN ADJUSTMENT] screen is displayed.
- 3) Press ▲▼ to select [CURVED CORRECTION].
- 4) Press the <ENTER> button.
  - The [CURVED CORRECTION] screen is displayed.
- 5) Press ▲▼ to select one item to adjust.

[KEYSTONE]	Adjusts when the trapezoid of the projected image is distorted.
[ARC]	Adjusts when the radian of the projected image is distorted.

- 6) Press the <ENTER> button.
  - The [KEYSTONE] or the [ARC] individual adjustment screen is displayed.

### Adjusting [KEYSTONE]

- 1) Press ▲▼◀▶ to adjust.
  - For details, please refer to [KEYSTONE] in [SCREEN ADJUSTMENT] menu. (➡ page 76)

### Adjusting [ARC]

- 1) Press ▲▼◀▶ to adjust.

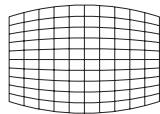
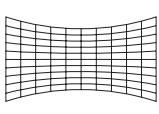
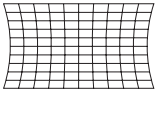
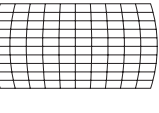
Items	Operation	Adjustment		
[H]	Press the ◀ button.	The top and the bottom of horizontal line will be bulge.		
	Press the ▶ button.	The top and the bottom of horizontal line will be dent.		
[V]	Press the ▲ button.	The left and the right of vertical line will be dent.		
	Press the ▼ button.	The left and the right of vertical line will be bulge.		

### Note

- One of [KEYSTONE], [CORNER CORRECTION] and [CURVED CORRECTION] setting value is valid. When [KEYSTONE], [CORNER CORRECTION] or [CURVED CORRECTION] adjustment is finished, you adjust the others, the adjusted value will be reset.
- Press the <SCREEN ADJ> button on the remote control when the [KEYSTONE], [CORNER CORRECTION] or [CURVED CORRECTION] screen is displaying, it will switch to the next adjustment screen.

- When the [CORNER CORRECTION] individual adjustment screen is displaying, the individual adjustment screen of the next corner can also be displayed by pressing the <ENTER> button.
- Correcting up to  $\pm 35^\circ$  for the tilt in the vertical direction and  $\pm 35^\circ$  for the tilt in the horizontal direction are available for adjustments with [KEYSTONE]. However, the image quality will degrade and it will get harder to focus with more correction. Install the projector so that the correction will be as small as possible.
- Screen size will also change when [KEYSTONE] is used to perform various adjustments.
- Aspect ratio of the image size may shift depending on the correction.

## [SHIFT]

(Only for RGB signals and YC<sub>B</sub>C<sub>R</sub>/YP<sub>B</sub>P<sub>R</sub> signals input)

Move the image position vertically or horizontally if the image position projected on the screen is shifted even when the relative position of the projector and the screen is installed correctly.

- 1) Press ▲▼ to select [SHIFT].
- 2) Press the <ENTER> button.
  - The [SHIFT] screen is displayed.
- 3) Press ▲▼◀▶ to adjust the position.

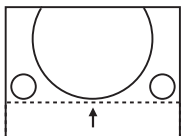
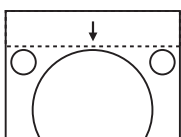
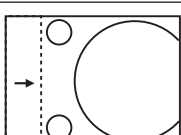
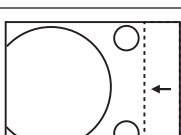
Orientation	Operation	Adjustment	
Vertical (up and down) adjustment	Press the ▲ button.	The image position moves up.	
	Press the ▼ button.	The image position moves down.	
Horizontal (right and left) adjustment	Press the ▶ button.	The image position moves to the right.	
	Press the ◀ button.	The image position moves to the left.	

### Note

- Depending on the input signal, if the adjustment of [SHIFT] exceeds the effective adjustment range of the input signal, the position of the image cannot be changed. Please adjust [SHIFT] within an effective adjustment range.

## [DOT CLOCK]

(Only for RGB signals and YC<sub>B</sub>C<sub>R</sub>/YP<sub>B</sub>P<sub>R</sub> signals (except for SYNC ON GREEN) input)

Use this function to adjust and minimize the effect of interference caused by projection of patterns consisting of vertical stripes.

The projection of the striped pattern may cause cyclic patterns (noise). Adjust so that the amount of interference is at a minimum. You can adjust the dot clock of image.

- 1) Press ▲▼ to select [DOT CLOCK].
- 2) Press ◀▶ or the <ENTER> button.
  - The [DOT CLOCK] individual adjustment screen is displayed.
- 3) Press ◀▶ to adjust the value.
  - The adjustment values are [-32] to [+32].

### Attention

- Set it before adjusting [CLOCK PHASE].

**Note**

- Depending on the input signal, if the adjustment of [DOT CLOCK] exceeds the effective adjustment range of the input signal, the position of the image cannot be changed. Please adjust [DOT CLOCK] within an effective adjustment range.

**[CLOCK PHASE]**

(Only for RGB signals and YC<sub>B</sub>C<sub>R</sub>/YP<sub>B</sub>P<sub>R</sub> signals input)

You can adjust to achieve an optimal image when there is a flickering image or smeared outlines.

- Press ▲▼ to select [CLOCK PHASE].
- Press ◀▶ or the <ENTER> button.
  - The [CLOCK PHASE] individual adjustment screen is displayed.
- Press ◀▶ to adjust.
  - Adjustment value will change between [-16] and [+16]. Adjust so that the amount of interference is at a minimum.

**Note**

- Certain signals may not be adjustable.
- Optimal value may not be achieved if the output from the input computer is unstable.
- To project a signal with dot clock frequency with 162 MHz or higher, noise may not disappear even if [CLOCK PHASE] is adjusted.
- [CLOCK PHASE] cannot be adjusted when a digital signal is input.

**[OVER SCAN]**

(Only for movie-based RGB signals, YC<sub>B</sub>C<sub>R</sub>/YP<sub>B</sub>P<sub>R</sub> signals, movie-based HDMI signals, movie-based DIGITAL LINK signals, VIDEO signals and Y/C signals input)

Use this function when characters or pictures are cropped near the periphery of the projected image.

- Press ▲▼ to select [OVER SCAN].
- Press ◀▶ or the <ENTER> button.
  - The [OVER SCAN] individual adjustment screen is displayed.
- Press ◀▶ to adjust the level.
  - The adjustment values are [0] to [+3].

**[ASPECT]**

You can switch the aspect ratio of the image.

The aspect ratio is switched within the screen range selected in [SCREEN FORMAT] of [DISPLAY OPTION] menu → [SCREEN SETTING]. Set [SCREEN FORMAT] first. (➡ page 87)

- Press ▲▼ to select [ASPECT].
- Press ◀▶ or the <ENTER> button.
  - The [ASPECT] individual adjustment screen is displayed.
- Press ◀▶ to switch the item.
  - The items will switch each time you press the button.

[NORMAL]	Displays images without changing the aspect ratio of the input signals.
[AUTO] <sup>*1</sup>	The aspect ratio is automatically switched to the optimum aspect ratio when an aspect ratio identifier is included in the input signal.
[WIDE]	Displays images with the aspect ratio converted to 16:9 when standard signals <sup>*2</sup> are input. Display images without changing the aspect ratio when wide-screen signals <sup>*3</sup> are input.
[H FIT]	Displays images using the entire width of the screen. When signals have the aspect ratio vertically longer than the aspect ratio of the screen selected in [SCREEN FORMAT], the images are displayed with the top and the bottom parts cut off.
[V FIT]	Displays the height of the panel pixels vertically without changing the aspect ratio when wide-screen signals are input. When signals have the aspect ratio horizontally longer than the aspect ratio of the screen, the images are displayed with the right and the left parts cut off.
[FULL]	The image is projected using all the panel (screen) pixels. The input signals are converted to the aspect ratio of the panel (screen).
[NATIVE]	Displays images without changing the resolution of the input signals.

- \*1 Only for video signal (NTSC) input
- \*2 Standard signals are input signals with an aspect ratio of 4:3 or 5:4.
- \*3 Wide-screen signals are input signals with an aspect ratio of 16:10, 16:9 or 15:9.

### Note

- The image size may be switched abnormally when [AUTO] is selected, please set to [NORMAL] or [WIDE] according to the input signal.
- Some size modes are not available for certain types of input signals.
- If an aspect ratio which is different from the aspect ratio for the input signals is selected, the images will appear differently from the originals. Be careful of this when selecting the aspect ratio.
- If using the projector in places such as cafes or hotels to display programs for a commercial purpose or for public presentation, note that adjusting the aspect ratio or using the zoom function to change the screen images may be an infringement of the rights of the original copyright owner for that program under copyright protection laws. Take care when using a function of the projector such as the aspect ratio adjustment and the zoom function.
- If conventional (normal) 4:3 images which are not wide-screen images are displayed on a wide screen, the edges of the images may not be visible or they may become distorted. Such images should be viewed as with an aspect ratio of 4:3 in the original format intended by the creator of the images.

### [FRAME LOCK]

(Only for still image RGB signals input)

This setting is available for specific computer signals. Set when the movie is distorted.

- 1) Press ▲▼ to select [FRAME LOCK].
- 2) Press ◀▶ or the <ENTER> button.
  - The [FRAME LOCK] individual adjustment screen is displayed.
- 3) Press ◀▶ to switch the [FRAME LOCK].
  - The items will switch each time you press the button.

[ON]	Enables the frame lock.
[OFF]	Disables the frame lock.

### [CLAMP POSITION]

You can adjust the optimal point when the black part of the image is blunt or it has turned green.

- 1) Press ▲▼ to select [CLAMP POSITION].
- 2) Press ◀▶ to adjust.

Status	Rough guide for optimal value	Range of adjustment
The black part is blunt.	The point where bluntness of the black part improves the most is the optimal value.	1 ~ 255
The black part is green.	The point where the green part becomes black, and the bluntness has improved is the optimal value.	

### Note

- [CLAMP POSITION] can be adjusted only when a signal is input to the <RGB 1 IN> terminal or the <RGB 2 IN> terminal.
- Some signals may not be adjusted.



## [LANGUAGE] menu

On the menu screen, select [LANGUAGE] from the main menu, and display the sub-menu. Refer to “Navigating through the menu” (➔ page 63) for the operation of the menu screen.

### Changing the display language

You can select the language of the on-screen display.

1) Press ▲▼ to select the display language and press the <ENTER> button.

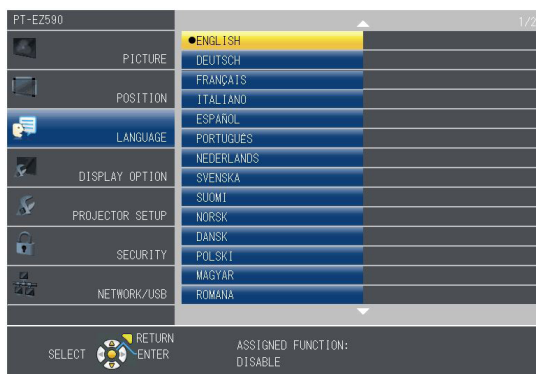

- Various menus, settings, adjustment screens, control button names, etc., are displayed in the selected language.
- The language can be changed to English, German, French, Italian, Spanish, Portuguese, Dutch, Swedish, Finnish, Norwegian, Danish, Polish, Hungarian, Romanian, Czech, Russian, Turkish, Arabic, Kazakh, Vietnamese, Chinese, Korean, Japanese and Thai.

#### Note

- The on-screen display language of the projector is set to English by default and when [INITIALIZE ALL] (➔ page 104) in [PROJECTOR SETUP] is executed.

## [DISPLAY OPTION] menu

On the menu screen, select [DISPLAY OPTION] from the main menu, and select an item from the sub-menu.

Refer to “Navigating through the menu” (➔ page 63) for the operation of the menu screen.

### [ON-SCREEN DISPLAY]

Set the on-screen display.

#### Setting [INPUT GUIDE]

You can set the display method of the name of the input terminal displayed on the top right of the projection screen.

- 1) Press ▲▼ to select [ON-SCREEN DISPLAY].
- 2) Press the <ENTER> button.
  - The [ON-SCREEN DISPLAY] screen is displayed.
- 3) Press ▲▼ to select [INPUT GUIDE].
- 4) Press ◀▶ to switch the item.
  - The items will switch each time you press the button.

[DETAILED]	Displays the name of input terminal and input signal graphically.
[OFF]	Disables the input guide.
[SIMPLE]	Displays the name of input terminal and input signal.

### [OSD POSITION]

Set the position of the menu screen (OSD).

- 1) Press ▲▼ to select [ON-SCREEN DISPLAY].
- 2) Press the <ENTER> button.
  - The [ON-SCREEN DISPLAY] screen is displayed.
- 3) Press ▲▼ to select [OSD POSITION].
- 4) Press ◀▶ to switch the item.
  - The items will switch each time you press the button as following:  
[CENTER] → [UPPER LEFT] → [UPPER RIGHT] → [LOWER LEFT] → [LOWER RIGHT] → [CENTER] → ...

### [OSD SIZE]

(Only for PT-EZ590)

Set the size of the menu screen (OSD).

- 1) Press ▲▼ to select [ON-SCREEN DISPLAY].
- 2) Press the <ENTER> button.
  - The [ON-SCREEN DISPLAY] screen is displayed.
- 3) Press ▲▼ to select [OSD SIZE].
- 4) Press ◀▶ to switch the item.

[NORMAL]	Use this setting normally.
[DOUBLE]	Double angle size (height and width will become two times) of [NORMAL].

### [WARNING MESSAGE]

Set the display/hide of the warning message.

- 1) Press ▲▼ to select [ON-SCREEN DISPLAY].
- 2) Press the <ENTER> button.
  - The [ON-SCREEN DISPLAY] screen is displayed.
- 3) Press ▲▼ to select [WARNING MESSAGE].
- 4) Press ◀▶ to switch the item.
  - The items will switch each time you press the button.

[OFF]	Hides the warning message.
[ON]	Displays the warning message.

### Note

- When [WARNING MESSAGE] is set to [OFF], the warning message will not be displayed on the projected image even if a warning status such as lamp replacement, temperature warning or air filter replacement is detected.

## [RGB IN]

Set to match the signal to input to the <RGB 1 IN> terminal and the <RGB 2 IN> terminal.

### Setting [RGB1 INPUT SETTING]

Switches the input for the <RGB 1 IN> terminal.

- 1) Press ▲▼ to select [RGB IN].
- 2) Press the <ENTER> button.
  - The [RGB IN] screen is displayed.
- 3) Press ▲▼ to select [RGB1 INPUT SETTING].
- 4) Press ◀▶ to switch the item.
  - The items will switch each time you press the button.

[RGB/YP <sub>B</sub> P <sub>R</sub> ]	Select when you want to input the RGB signal or YP <sub>B</sub> P <sub>R</sub> (YC <sub>B</sub> C <sub>R</sub> ) signal to the <RGB 1 IN> terminal.
[Y/C]	Select when you want to input a luminance signal and a color signal to the <RGB 1 IN> terminal.

### Setting [RGB2 EDID MODE]

- 1) Press ▲▼ to select [RGB IN].
- 2) Press the <ENTER> button.
  - The [RGB IN] screen is displayed.
- 3) Press ▲▼ to select [RGB2 EDID MODE].
- 4) Press the <ENTER> button.
  - The [RGB2 EDID MODE] screen is displayed.
- 5) Press ◀▶ to switch [EDID MODE].
  - The items will switch each time you press the button.

[DEFAULT]	Standard setting.
[SCREEN FIT]	Changes EDID data according to the [SCREEN FORMAT] setting.
[USER]	Sets the [RESOLUTION] and [VERTICAL SCAN FREQUENCY] items to EDID.

- When [DEFAULT] or [SCREEN FIT] is selected, proceed to Step 10).

- 6) Press the <ENTER> button.
  - The [RESOLUTION] screen is displayed.
- 7) Press ▲▼ to select [RESOLUTION].
  - Select [1024x768p], [1280x720p], [1280x800p], [1280x1024p], [1366x768p], [1400x1050p], [1440x900p], [1600x900p], [1600x1200p], [1680x1050p], [1920x1080p], [1920x1080i] or [1920x1200p].
- 8) Press the <ENTER> button.

- The [VERTICAL SCAN FREQUENCY] screen is displayed.

9) Press ◀▶ to select [VERTICAL SCAN FREQUENCY].

- Select [60Hz], [50Hz], [30Hz], [25Hz] or [24Hz] when [1920x1080p] is selected for [RESOLUTION].
- Select [60Hz], [50Hz] or [48Hz] when [1920x1080i] is selected for [RESOLUTION].
- The value is fixed to [60Hz] when [1280x1024p], [1400x1050p], [1440x900p] or [1600x1200p] is selected for [RESOLUTION].
- Select [60Hz] or [50Hz] when anything other than the above signals are selected for [RESOLUTION].

10) Press the <ENTER> button.

- The confirmation screen is displayed.

11) Press ◀▶ to select [OK], and press the <ENTER> button.

### Note

- The setting details are displayed in [RESOLUTION] and [VERTICAL SCAN FREQUENCY] below [EDID MODE].
- The resolution and vertical scanning frequency settings may be required on your computer or video device.
- After configuring settings, your computer or video device or the projector may be required to be restarted.
- Output with resolution and vertical scanning frequency that have been set may not be performed depending on your computer or video device.
- When the image is displayed incorrectly even if the format is selected in [EDID MODE], please check the settings of [WIDE MODE] (▶ page 90) or [SXGA MODE] (▶ page 90).

## [HDMI IN]

Switch the setting when the external device is connected to the <HDMI 1 IN> terminal or the <HDMI 2 IN> terminal of the projector and the image is not projected correctly.

1) Press ▲▼ to select [HDMI IN].

2) Press the <ENTER> button.

- The [HDMI IN] screen is displayed.

3) Press ▲▼ to select [SIGNAL LEVEL].

4) Press ◀▶ to switch the item.

- The items will switch each time you press the button.

[AUTO]	Sets the signal level automatically.
[64-940]	Select when the HDMI terminal of an external device (such as a blu-ray player) is connected to the <HDMI 1 IN> terminal or the <HDMI 2 IN> terminal.
[0-1023]	Select when the DVI terminal output of an external device (such as a computer) is connected to the <HDMI 1 IN> terminal or the <HDMI 2 IN> terminal via a conversion cable or similar cable. Select also when the HDMI terminal output of a computer or other device is connected to the <HDMI 1 IN> terminal or the <HDMI 2 IN> terminal.

### Note

- The same setting of the [SIGNAL LEVEL] is set to the <HDMI 1 IN> terminal and <HDMI 2 IN> terminal.
- The optimal setting varies depending on the output setting of the connected external device. Refer to the operation instruction of the external device regarding the output of the external device.
- The displayed signal level is assumed when the input is 30 bits.

## Setting [EDID MODE]

1) Press ▲▼ to select [HDMI IN].

2) Press the <ENTER> button.

- The [HDMI IN] screen is displayed.

3) Press ▲▼ to select [EDID MODE].

4) Press the <ENTER> button.

- The [HDMI EDID MODE] screen is displayed.

5) Press ◀▶ to switch [EDID MODE].

- The items will switch each time you press the button.

[DEFAULT]	Standard setting.
[SCREEN FIT]	Changes EDID data according to the [SCREEN FORMAT] setting.
[USER]	Sets the [RESOLUTION] and [VERTICAL SCAN FREQUENCY] items to EDID.

- When [DEFAULT] or [SCREEN FIT] is selected, proceed to Step 10).

6) Press the <ENTER> button.

- The [RESOLUTION] screen is displayed.

7) Press ▲▼ to select [RESOLUTION].

- Select [1024x768p], [1280x720p], [1280x800p], [1280x1024p], [1366x768p], [1400x1050p], [1440x900p], [1600x900p], [1600x1200p], [1680x1050p], [1920x1080p], [1920x1080i] or [1920x1200p].

8) Press the <ENTER> button.

- The [VERTICAL SCAN FREQUENCY] screen is displayed.

9) Press ◀▶ to select [VERTICAL SCAN FREQUENCY].

- Select [60Hz], [50Hz], [30Hz], [25Hz] or [24Hz] when [1920x1080p] is selected for [RESOLUTION].
- Select [60Hz], [50Hz] or [48Hz] when [1920x1080i] is selected for [RESOLUTION].
- The value is fixed to [60Hz] when [1280x1024p], [1400x1050p], [1440x900p] or [1600x1200p] is selected for [RESOLUTION].
- Select [60Hz] or [50Hz] when anything other than the above signals are selected for [RESOLUTION].

10) Press the <ENTER> button.

- The confirmation screen is displayed.

11) Press ◀▶ to select [OK], and press the <ENTER> button.

**Note**

- The same setting of the [EDID MODE] is set to the <HDMI 1 IN> terminal and the <HDMI 2 IN> terminal.
- The setting details are displayed in [RESOLUTION] and [VERTICAL SCAN FREQUENCY] below [EDID MODE].
- The resolution and vertical scanning frequency settings may be required on your computer or video device.
- After configuring settings, your computer or video device or the projector may be required to be restarted.
- Output with resolution and vertical scanning frequency that have been set may not be performed depending on your computer or video device.

**[DIGITAL LINK IN]**

(Only for PT-EZ590, PT-EW650 and PT-EX620)

Set the signal level when DIGITAL LINK input is selected.

1) Press ▲▼ to select [DIGITAL LINK IN].

2) Press the <ENTER> button.

- The [DIGITAL LINK IN] screen is displayed.

3) Press ▲▼ to select [SIGNAL LEVEL].

4) Press ◀▶ to switch the item.

- The items will switch each time you press the button.

[AUTO]	Automatically sets the signal level.
[64-940]	Select when the HDMI terminal output of an external device (such as a Blu-ray disc player) is connected to the <DIGITAL LINK/LAN> terminal via a twisted-pair-cable transmitter.
[0-1023]	Select when the DVI-D terminal output or the HDMI terminal output of an external device (such as a computer) is connected to the <DIGITAL LINK/LAN> terminal via a twisted-pair-cable transmitter.

**Note**

- The optimal setting varies depending on the output setting of the connected external device. Refer to the operation instruction of the external device regarding the output of the external device.
- The displayed signal level is assumed when the input is 30 bits.

**Setting [EDID MODE]**

1) Press ▲▼ to select [DIGITAL LINK IN].

- 2) Press the <ENTER> button.
  - The [DIGITAL LINK IN] screen is displayed.
- 3) Press ▲▼ to select [EDID MODE].
- 4) Press the <ENTER> button.
  - The [DIGITAL LINK EDID MODE] screen is displayed.
- 5) Press ◀▶ to switch [EDID MODE].
  - The items will switch each time you press the button.

[DEFAULT]	Standard setting.
[SCREEN FIT]	Changes EDID data according to the [SCREEN FORMAT] setting.
[USER]	Sets the [RESOLUTION] and [VERTICAL SCAN FREQUENCY] items to EDID.

- When [DEFAULT] or [SCREEN FIT] is selected, proceed to Step 10).

- 6) Press the <ENTER> button.
  - The [RESOLUTION] screen is displayed.
- 7) Press ▲▼ to select [RESOLUTION].
  - Select [1024x768p], [1280x720p], [1280x800p], [1280x1024p], [1366x768p], [1400x1050p], [1440x900p], [1600x900p], [1600x1200p], [1680x1050p], [1920x1080p], [1920x1080i] or [1920x1200p].
- 8) Press the <ENTER> button.
  - The [VERTICAL SCAN FREQUENCY] screen is displayed.
- 9) Press ◀▶ to select [VERTICAL SCAN FREQUENCY].
  - Select [60Hz], [50Hz], [30Hz], [25Hz] or [24Hz] when [1920x1080p] is selected for [RESOLUTION].
  - Select [60Hz], [50Hz] or [48Hz] when [1920x1080i] is selected for [RESOLUTION].
  - The value is fixed to [60Hz] when [1280x1024p], [1400x1050p], [1440x900p] or [1600x1200p] is selected for [RESOLUTION].
  - Select [60Hz] or [50Hz] when anything other than the above signals are selected for [RESOLUTION].
- 10) Press the <ENTER> button.
  - The confirmation screen is displayed.
- 11) Press ◀▶ to select [OK], and press the <ENTER> button.

#### Note

- The setting details are displayed in [RESOLUTION] and [VERTICAL SCAN FREQUENCY] below [EDID MODE].
- The resolution and vertical scanning frequency settings may be required on your computer or video device.
- After configuring settings, your computer or video device or the projector may be required to be restarted.
- Output with resolution and vertical scanning frequency that have been set may not be performed depending on your computer or video device.

### [CLOSED CAPTION SETTING] (Only for NTSC, 480i YC<sub>B</sub>C<sub>R</sub> input)

Set the closed caption.

#### Selecting the closed caption display

- 1) Press ▲▼ to select [CLOSED CAPTION SETTING].
- 2) Press the <ENTER> button.
  - The [CLOSED CAPTION SETTING] screen is displayed.
- 3) Press ▲▼ to select [CLOSED CAPTION].
- 4) Press ◀▶ to switch the item.
  - The items will switch each time you press the button.

[OFF]	Closed captions are not displayed.
[ON]	Closed captions are displayed.

- When [ON] is selected, proceed to Step 5).

- 5) When the confirmation screen is displayed, press ◀▶ to select [OK], and press the <ENTER> button.

### Setting the closed caption mode

- 1) Press ▲▼ to select [CLOSED CAPTION SETTING].
- 2) Press the <ENTER> button.
  - The [CLOSED CAPTION SETTING] screen is displayed.
- 3) Press ▲▼ to select [MODE].
  - When [CLOSED CAPTION] is set to [OFF], [MODE] cannot be selected.
- 4) Press ◀▶ to switch the item.
  - The items will switch each time you press the button.

[CC1]	Displays CC1 data.
[CC2]	Displays CC2 data.
[CC3]	Displays CC3 data.
[CC4]	Displays CC4 data.

### Note

- Closed caption is a function that displays text information of video signals mainly used in North America. Captions may not be displayed depending on the connected devices or contents being played back.
- [CLOSED CAPTION SETTING] can only be selected if an NTSC or 480i YC<sub>B</sub>C<sub>R</sub> signal is input.
- If [CLOSED CAPTION] is set to [ON], the brightness of image may be changed according to the external devices or the used content of the closed caption corresponding connection.
- If a closed caption signal of the selected mode is input, the security message set in the [SECURITY] menu → [DISPLAY SETTING] (▶ page 105) is not displayed.
- Closed captions are not displayed when the menu screen is displayed.

### [SCREEN SETTING]

Set the screen size.

Correct to the optimum image position for the set screen when changing the aspect ratio of a projected image. Set as necessary for the screen in use.

- 1) Press ▲▼ to select [SCREEN SETTING].
  - 2) Press the <ENTER> button.
    - The [SCREEN SETTING] screen is displayed.
  - 3) Press ▲▼ to select [SCREEN FORMAT].
  - 4) Press ◀▶ to switch the [SCREEN FORMAT] item.
    - The items will switch each time you press the button.
- For PT-EZ590

[SCREEN FORMAT]	Description	Range when [SCREEN POSITION] is selected
[16:10]	The projected aspect ratio is 16:10.	The vertical position cannot be adjusted.
[16:9]	The projected aspect ratio is 16:9.	Adjusts the vertical position.
[4:3]	The projected aspect ratio is 4:3.	Adjusts the horizontal position.

■ For PT-EW650, PT-EW550

[SCREEN FORMAT]	Description	Range when [SCREEN POSITION] is selected
[16:10]	The projected aspect ratio is 16:10.	The vertical position cannot be adjusted.
[16:9]	The projected aspect ratio is 16:9.	Adjusts the vertical position.

■ For PT-EX620, PT-EX520

[SCREEN FORMAT]	Description	Range when [SCREEN POSITION] is selected
[4:3]	The projected aspect ratio is 4:3	The vertical position cannot be adjusted.
[16:9]	The projected aspect ratio is 16:9.	Adjusts the vertical position.

- 5) Press ▲▼ to select [SCREEN POSITION].

- [SCREEN POSITION] cannot be selected or adjusted when [SCREEN FORMAT] is set to the following item.  
PT-EZ590, PT-EW650 and PT-EW550: [16:10]  
PT-EX620 and PT-EX520: [4:3]

6) Press ◀▶ to adjust the [SCREEN POSITION].

- The items will switch each time you press the button.

■ When [SCREEN FORMAT] is [16:9]

[CENTER]	The image which aspect ratio is 16:9 will displayed in the center.
[HIGH]	The image which aspect ratio is 16:9 will displayed at the top.
[LOW]	The image which aspect ratio is 16:9 will displayed at the bottom.

■ When [SCREEN FORMAT] is [4:3]  
(Only for PT-EZ590)

[CENTER]	The image which aspect ratio is 4:3 will displayed at the center.
[LEFT]	The image which aspect ratio is 4:3 will displayed in the left.
[RIGHT]	The image which aspect ratio is 4:3 will displayed at the right.

## [STARTUP LOGO]

Set the logo display when the power is turned on.

1) Press ▲▼ to select [STARTUP LOGO].

2) Press ◀▶ to switch the item.

- The items will switch each time you press the button.

[DEFAULT LOGO]	Displays the Panasonic logo.
[USER LOGO]	Displays the image registered by the user.
[OFF]	Disables the startup logo display.

### Note

- The startup logo will disappear in approximately 30 seconds.
- To create/register the [USER LOGO] image, use "Logo Transfer Software" included in the supplied CD-ROM.

## [SHUTTER SETTING]

(Only for PT-EZ590, PT-EW650 and PT-EX620)

Enable/disable the shutter function automatically (shutter: closed/open) when the power is turned on.

### Setting [STARTUP]

1) Press ▲▼ to select [SHUTTER SETTING].

2) Press the <ENTER> button.

- The [SHUTTER SETTING] screen is displayed.

3) Press ▲▼ to select [STARTUP].

4) Press ◀▶ to switch the item.

[OPEN]	Starts projection with the shutter function disabled (shutter: open) when the power is turned on.
[CLOSE]	Starts projection with the shutter function enabled (shutter: closed) when the power is turned on.

### Setting [SHUT-OFF]

1) Press ▲▼ to select [SHUTTER SETTING].

2) Press the <ENTER> button.

- The [SHUTTER SETTING] screen is displayed.

3) Press ▲▼ to select [SHUT-OFF].



## 4) Press ◀▶ to switch the item.

[KEEP CURRENT STATE]	When the projector is switched off, the projector turns into standby with the shutter status left as is.
[OPEN]	When the projector is switched off, the projector turns into standby with the shutter left opened.
[CLOSE]	When the projector is switched off, the projector turns into standby with the shutter left closed.

**[AUTO SETUP SETTING]**

Set the automatic execution of AUTO SETUP.

The screen display position or signal level can be adjusted automatically without pressing the <AUTO SETUP> button on the remote control on each occasion if you input unregistered signals frequently at meetings, etc.

## 1) Press ▲▼ to select [AUTO SETUP SETTING].

## 2) Press ◀▶ to switch the item.

- The items will switch each time you press the button.

[AUTO]	Enables the auto setup function when switching signals.
[BUTTON]	Enables the auto setup function only when the <AUTO SETUP> button is pressed.

**[SIGNAL SEARCH]**

When the power is turned on, this function automatically detects the terminal which signals are input and sets the function to switch.

## 1) Press ▲▼ to select [SIGNAL SEARCH].

## 2) Press ◀▶ to switch the item.

- The items will switch each time you press the button.

[ON]	Enables input detection automatically.
[OFF]	Disables input detection automatically.

**Note**

- If the [SIGNAL SEARCH] is set to [ON] when there is no signal input, press the <AUTO SETUP> button on the remote control, this function automatically detects the terminal to which signals are input and then switches.

**[STARTUP INPUT SELECT]**

Set the input when the projector is switched on to start projection.

## 1) Press ▲▼ to select [STARTUP INPUT SELECT].

## 2) Press the &lt;ENTER&gt; button.

- The [STARTUP INPUT SELECT] screen is displayed.

## 3) Press ▲▼ to select an item.

- The items will switch each time you press the button.

[LAST USED]	Keeps the input selected last.
[NETWORK]	Sets the input to NETWORK.
[RGB1]	Sets the input to RGB1.
[RGB2]	Sets the input to RGB2.
[HDMI1]	Sets the input to HDMI1.
[HDMI2]	Sets the input to HDMI2.
[VIDEO]	Sets the input to VIDEO.
[DIGITAL LINK] <sup>*1</sup>	Sets the input to DIGITAL LINK.
[INPUT1] ~ [INPUT10] <sup>*1*2</sup>	Sets the input to DIGITAL LINK, and switches the input of Panasonic twisted-pair-cable transmitter to the specified input.

\*1 Only for PT-EZ590, PT-EW650 and PT-EX620

\*2 When the optional DIGITAL LINK output supported device (Model No.: ET-YFB100G, ET-YFB200G) is connected to the projector, its input name is automatically reflected from [INPUT1] to [INPUT10]. If an item where the input name is not reflected is selected, it is disabled.

**Note**

- When [SIGNAL SEARCH] is set to [ON], the [STARTUP INPUT SELECT] cannot be set.

**[BACK COLOR]**

Set the display of the projected screen when there is no signal input.

- 1) Press ▲▼ to select [BACK COLOR].
- 2) Press ◀▶ to switch the item.
  - The items will switch each time you press the button.

[BLUE]	Displays the entire projection area in blue.
[BLACK]	Displays the entire projection area in black.
[DEFAULT LOGO]	Displays the Panasonic logo.
[USER LOGO]	Displays the image registered by the user.

**Note**

- To create/register the [USER LOGO] image, use “Logo Transfer Software” included in the supplied CD-ROM.

**[WIDE MODE]**

Using this function when the image is displayed incorrectly for the input signals.

- 1) Press ▲▼ to select [WIDE MODE].
- 2) Press ◀▶ to switch the item.
  - The items will switch each time you press the button.

[AUTO]	Displays by judging the signal automatically. Set to this mode normally.
[ON]	When input the wide signal.
[OFF]	When input the 4:3 signal.

**[SXGA MODE]**

This function is used if the whole projected image is not displayed when the resolution 1 280 x 1 024 dots of the SXGA signal is input.

- 1) Press ▲▼ to select [SXGA MODE].
- 2) Press ◀▶ to switch the item.
  - The items will switch each time you press the button.

[AUTO]	Displays by judging the signal automatically. Set to this mode normally.
[1280x1024]	Switches the item to [1280x1024] or [1400x1050] manually if the whole projected image is not displayed when SXGA signal is input.
[1400x1050]	

**[P-TIMER]**

Set and operate the presentation timer function.

**Setting the mode**

- 1) Press ▲▼ to select [P-TIMER].
- 2) Press the <ENTER> button.
  - The [P-TIMER] screen is displayed.
- 3) Press ▲▼ to select [MODE].
- 4) Press ◀▶ to switch the item.
  - The items will switch each time you press the button.

[COUNT UP]	Displays the elapsed time since the count was started.
[COUNT DOWN]	Displays the remaining time of the time set by [TIMER].

## Setting the countdown timer

- 1) Press ▲▼ to select [P-TIMER].
- 2) Press the <ENTER> button.
  - The [P-TIMER] screen is displayed.
- 3) Press ▲▼ to select [TIMER].
- 4) Press ◀▶ to set the time.
  - The time can be set in 1-minute increments from 1 to 180 minutes.
  - The factory default value is 10 minutes.

### Note

- [TIMER] is enabled when [MODE] is set to [COUNT DOWN].

## Using the presentation timer

- 1) Press ▲▼ to select [P-TIMER].
- 2) Press the <ENTER> button.
  - The [P-TIMER] screen is displayed.
- 3) Press ▲▼ to select the item, and press the <ENTER> button.

[START]	The count is started.
[STOP]	The count is stopped.
[RESTART]	The count is resumed.
[RESET]	The count is reset.

- When [START] or [RESTART] is selected, the elapsed time or the remaining time is displayed at the bottom right of the projected image.
  - When [STOP] is selected, the elapsed time or the remaining time when the count was stopped is displayed at the bottom right of the projected image.
  - When [RESET] is selected, proceed to Step 4).
- 4) Press the <MENU> button three times, then menu screen will disappear.
    - The P-TIMER function is cancelled.

### Note

- Presentation timer operations are also possible by the <P-TIMER> button on the remote control. (➔ page 58)
- The security message set in the [SECURITY] menu → [DISPLAY SETTING] (➔ page 105) is not displayed when the elapsed time or remaining time is displayed.
- The elapsed time or remaining time are not displayed when the menu screen is displayed.
- The start time becomes "000:00" when [MODE] is set to [COUNT UP].
- When [MODE] is set to [COUNT DOWN], the start time becomes the value set at [TIMER].
- The time gauge turns clockwise when [COUNT UP] is set, and turns counterclockwise when [COUNT DOWN] is set.

## Ending the presentation timer

- 1) Press ▲▼ to select [P-TIMER].
- 2) Press the <ENTER> button.
  - The [P-TIMER] screen is displayed.
- 3) Press ▲▼ to select [EXIT].
- 4) Press the <ENTER> button.

## [OTHER FUNCTIONS]

You can perform some of the remote control button operations by using the sub-menu.

- 1) Press ▲▼ to select [OTHER FUNCTIONS].

- 2) Press the <ENTER> button.
  - The [OTHER FUNCTIONS] screen is displayed.
- 3) Press ▲▼ to select the item.

[AUTO SETUP]	Automatically adjust the resolution, the clock phase and the image position when analog RGB signals consisting of bitmap images such as computer signals are being input, or to automatically adjust the image position when HDMI signals are input. For details, refer to "Using the automatic setup function". (➡ page 56)
[FREEZE]	The projected image is paused temporarily and the sound stopped regardless of the playback of the external equipment. Press the <MENU> button on the remote control to release this function. Also press the <RETURN> button or the <FREEZE> button on the remote control to release this function.
[SHUTTER] <sup>*1</sup>	Enable/disable the shutter function automatically (shutter: closed/open) when the power is turned on.
[AV MUTE] <sup>*2</sup>	Turn off audio and image when the projector is not used for a certain period of time. To release this function, press the <RETURN> button or the <AV MUTE> button on the remote control.
[DIGITAL ZOOM]	Enlarge images and move the image zoom position. For details, refer to "Using the digital zoom function". (➡ page 59)

\*1 Only for PT-EZ590, PT-EW650 and PT-EX620

\*2 Only for PT-EW550 and PT-EX520

- 4) Press the <ENTER> button.

### Using the digital zoom function via the menu operation

(Only for still image-based RGB signals/still image-based HDMI signals/still image-based DIGITAL LINK signals input)

- 1) Press ▲▼ to select [DIGITAL ZOOM].
- 2) Press the <ENTER> button.
  - The [DIGITAL ZOOM] individual adjustment screen is displayed.
- 3) Press ◀▶ to adjust the magnification.

Operation menu	Operation	Adjustment	Adjustment range
	Press the ▶ button.	Increases magnification.	1.0 ~ 3.0
	Press the ◀ button.	Decreases magnification.	

- 4) Press the <ENTER> button.
  - The moving screen is displayed.
- 5) Press ▲▼◀▶ to move the zoom position.
  - For details, refer to "Using the digital zoom function". (➡ page 59)

### Note

- Magnification can be set from 1.0x to 3.0x in 0.1 increments.
- The digital zoom function is canceled if the <D.ZOOM -> button/<D.ZOOM +> button is pressed for three seconds or more.
- The digital zoom function is canceled if the input signal changes during a digital zoom.
- During a digital zoom, the freeze function is disabled.
- The digital zoom function may not work properly for some still image-based signals.

## [PROJECTOR SETUP] menu

On the menu screen, select [PROJECTOR SETUP] from the main menu, and select an item from the sub-menu.

Refer to “Navigating through the menu” (➔ page 63) for the operation of the menu screen.

### [STATUS]

Display the status of the projector.

- 1) Press ▲▼ to select [STATUS].
- 2) Press the <ENTER> button.
  - The [STATUS] screen is displayed.

[SIGNAL]	[NAME]	Displays the name of input signal.
	[FREQUENCY]	Displays the scanning frequency of input signal.
[RUNTIME]*1	[PROJECTOR]	Displays the current usage time of projector.
	[LAMP (ET-LAEF100*2)]	Displays the model No. of the replacement lamp unit for this projector.
	[ECO]	Displays the lamp runtime when [LAMP POWER] is set to [ECO] by actual time.
	[NORMAL]	Displays the lamp runtime when [LAMP POWER] is set to [NORMAL] by actual time.
[SERIAL NUMBER]	[PROJECTOR]	Displays the serial number of the projector.

\*1 The following conversion is required to calculate the rough estimate for lamp replacement.

Formula for lamp replacement time (rough estimate)
$A \times 1 + B \times 4/5$ <ul style="list-style-type: none"> <li>• A : Runtime which is displayed in [STATUS] screen → [RUNTIME] → [LAMP] → [NORMAL]</li> <li>• B : Runtime which is displayed in [STATUS] screen → [RUNTIME] → [LAMP] → [ECO]</li> </ul>

\*2 The model No. of the optional lamp unit is subject to change without prior notice.

### Note

- The “RUNTIME” displayed in the [STATUS] may be different from the actual times when a lamp unit that was attached to a different projector model is installed on this projector (PT-EZ590, PT-EW650, PT-EW550, PT-EX620, PT-EX520), or when the lamp unit that was attached to this projector is installed on a different projector model.
- The [SIGNAL] is shown in gray and the values are blank for [NETWORK] input.

### [PROJECTOR ID]

The projector has an ID number setting function that can be used when multiple projectors are used side by side to enable simultaneous control or individual control via a single remote control.

- 1) Press ▲▼ to select [PROJECTOR ID].
- 2) Press ◀▶ to switch the item.
  - The items will switch each time you press the button.

[ALL]	Select this item to control projectors without specifying an ID number.
[1] ~ [64]	Select this item when specifying an ID number to control individual projector.

### Note

- To specify an ID number for individual control, the ID number of a remote control must match the ID number of the projector.
- When the ID number is set to [ALL], the projector will operate regardless of the ID number specified during remote control or computer control.  
If multiple projectors are set up side by side with ID set to [ALL], they cannot be controlled separately from the projectors with other ID numbers.
- Refer to “Setting the ID number of the remote control” (➔ page 61) for how to set the ID number on the remote control.

### [INITIAL START UP]

Set the method of start up when the power cord plugged into the AC outlet.

- 1) Press ▲▼ to select [INITIAL START UP].
- 2) Press ◀▶ to switch the item.

- The items will switch each time you press the button.

[LAST MEMORY]	Starts in the condition that before disconnected the power cord or turn off the breaker.
[STANDBY]	Starts up in the standby mode.
[ON]	Starts the projection immediately.

## [PROJECTION METHOD]

Set the projection method in accordance with the installation status of the projector.

Change the projection method if the screen display is upside down or inverted.

- 1) Press ▲▼ to select [PROJECTION METHOD].
- 2) Press ◀▶ to switch the projection method.
  - The items will switch each time you press the button.

[AUTO]	The projector's posture can be detected automatically by the built-in angle sensor, then switch to [FRONT/DESK] or [FRONT/CEILING]. When projecting in front of the screen, please set to [AUTO].
[FRONT/DESK]	When installing the projector on the desk, etc., in front of the screen.
[FRONT/CEILING]	When installing the projector in front of the screen with the Ceiling Mount Bracket (optional).
[REAR/DESK]	When installing the projector on the desk, etc., behind the screen (with a translucent screen).
[REAR/CEILING]	When installing the projector behind the screen (with a translucent screen) with the Ceiling Mount Bracket (optional).

### Note

- When set to [AUTO], front projection or rear projection cannot be detected. When projecting from rear, please set the [PROJECTION METHOD] to [REAR/DESK] or [REAR/CEILING].
- As for the range of installation posture detected by the projector's built-in angle sensor, please refer to "Angle sensor". (➡ page 31)

## [LAMP POWER]

Switch the brightness of the lamp according to the operating environment of the projector or the purpose.

- 1) Press ▲▼ to select [LAMP POWER].
- 2) Press ◀▶ to switch the item.
  - The items will switch each time you press the button.

[NORMAL]	Select when high luminance is required.
[ECO]	Select when high luminance is not required.

### Note

- Set it to [ECO] rather than [NORMAL] when you want to reduce power consumption, extend the life of lamp and reduce operation noise.
- The [LAMP POWER] is fixed to [ECO] when the [PICTURE] menu → [PICTURE MODE] (➡ page 67) is set to [DICOM SIM].
- The [LAMP POWER] changes to [ECO] forcibly to protect the projector when the operating environment temperature becomes 40 °C (104 °F) or higher (35 °C (95 °F) or higher when used at high altitude). And, even if the [PROJECTOR SETUP] menu → [LAMP POWER] is set to [NORMAL], the [LAMP POWER] changes to [ECO] automatically.

## [ECO MANAGEMENT]

This function optimizes lamp power according to the operating status to reduce power consumption.

### Setting [AUTO POWER SAVE]

Set whether or not to enable the [AMBIENT LIGHT DETECTION], [SIGNAL DETECTION], [SHUTTER DETECTION]<sup>1</sup> and [AV MUTE DETECTION]<sup>2</sup> functions.

- 1) Press ▲▼ to select [ECO MANAGEMENT].
- 2) Press the <ENTER> button.
  - The [ECO MANAGEMENT] screen is displayed.
- 3) Press ▲▼ to select [AUTO POWER SAVE].
- 4) Press ◀▶ to switch the item.
  - The items will switch each time you press the button.

[ON]	Enables the energy conservation setting.
[OFF]	Disables the energy conservation setting.

- 5) Press ▲▼ to select [AMBIENT LIGHT DETECTION], [SIGNAL DETECTION], [SHUTTER DETECTION] \*1 or [AV MUTE DETECTION] \*2.

[AMBIENT LIGHT DETECTION]	Adjusts the power of the lamp according to the brightness of the installation location.
[SIGNAL DETECTION]	Lowers the power of the lamp when there is no signal.
[SHUTTER DETECTION] *1	Lowers the power of the lamp when the shutter is closed.
[AV MUTE DETECTION]*2	Lowers the power of the lamp when the [AV MUTE] is [ON].

\*1 Only for PT-EZ590, PT-EW650 and PT-EX620

\*2 Only for PT-EW550 and PT-EX520

- 6) Press ◀▶ to switch the item.
- The items will switch each time you press the button.

[ON]	Enables the setting.
[OFF]	Disables the setting.

### Note

- Lamp power cannot be reduced automatically in the following cases:
  - When the lamp lighting is just completed or the setting of [LAMP POWER] is just completed, etc..
- When [AUTO POWER SAVE] is set to [OFF], settings of [AMBIENT LIGHT DETECTION], [SIGNAL DETECTION], [SHUTTER DETECTION] or [AV MUTE DETECTION] are unavailable.
- When [LAMP POWER] is set to [ECO], settings of [AMBIENT LIGHT DETECTION], [SIGNAL DETECTION], [SHUTTER DETECTION] or [AV MUTE DETECTION] are unavailable.
- When objects, etc. are placed around the luminance sensor on the top of the projector, [AMBIENT LIGHT DETECTION] may not function properly.

### Setting [POWER MANAGEMENT]

Set the operation as following if there is no signal input.

- Press ▲▼ to select [ECO MANAGEMENT].
- Press the <ENTER> button.
  - The [ECO MANAGEMENT] screen is displayed.
- Press ▲▼ to select [POWER MANAGEMENT].
- Press ◀▶ to switch the item.
  - The items will switch each time you press the button.

[SHUT DOWN]	The countdown timer is displayed after 30 seconds without input signal. The projection lamp is turned off and cooled down when reached the set time, then the projector enter into standby status.
[OFF]	Power management function is off.
[READY]	The countdown timer is displayed after 30 seconds without input signal. The projection lamp turns off and cools down when reaching the set time, meanwhile the projector is in the power management mode. The projection lamp will be turned on if the input signal is reconnected or any button is pressed.

### Setting [TIMER]

The timer can be set to 5-120 minutes. The increment is 5 minutes.

- Press ▲▼ to select [TIMER].
- Press ◀▶ to set the timer.
  - The time will switch each time you press the button.

### Setting [STANDBY MODE]

Set the power consumption during standby.

- Press ▲▼ to select [ECO MANAGEMENT].
- Press the <ENTER> button.

- The [ECO MANAGEMENT] screen is displayed.

3) Press ▲▼ to select [STANDBY MODE].

4) Press ◀▶ to switch the item.

- The items will switch each time you press the button.

[NORMAL]	Select this item to use the network function or the serial communication function during standby.
[ECO]	Select this item to reduce power consumption during standby.

#### Note

- If [STANDBY MODE] is set to [ECO], you cannot use network functions when the projector is standing by. Also, you cannot use some RS-232C protocol commands.
- When set to [ECO], it may take approx. 10 seconds longer before the projector starts projecting after the power is turned on, compared with when [NORMAL] is set.
- When set to [NORMAL], it may take approx. 1 minute to enable the network function after connecting the power cord.
- The setting of [STANDBY MODE] cannot be returned to the factory default even if the [PROJECTOR SETUP] menu → [INITIALIZE ALL] is executed. (➔ page 104)

## [RS-232C]

Set the communication conditions of the <SERIAL IN> terminal.

### Setting the communication condition of the <SERIAL IN> terminal

1) Press ▲▼ to select [RS-232C].

2) Press the <ENTER> button.

- The [RS-232C] screen is displayed.
- Only for PT-EW550 and PT-EX520, proceed to step 5).

3) Press ▲▼ to select [INPUT SELECT].

4) Press ◀▶ to switch the item.

[PROJECTOR]	Use the <SERIAL IN> terminal of the projector to perform RS-232C communication.
[DIGITAL LINK]	Performs RS-232C communication via the DIGITAL LINK output supported device (Model No.: ET-YFB100G, ET-YFB200G) and the <DIGITAL LINK/LAN> terminal.

5) Press ▲▼ to select [BAUDRATE].

6) Press ◀▶ to switch the item.

- The items will switch each time you press the button.

[9600]	Select the proper speed.
[19200]	
[38400]	

7) Press ▲▼ to select [PARITY].

8) Press ◀▶ to switch the item.

- The items will switch each time you press the button.

[NONE]	Select the parity condition.
[EVEN]	
[ODD]	

### Setting the control commands of an existing projector

When controlling the projector on a computer, set use of control commands on a previously purchased Panasonic projector. This allows the control software for an existing Panasonic projector to be inherited and used.

1) Press ▲▼ to select [RS-232C].

2) Press the <ENTER> button.

- The [RS-232C] screen is displayed.



- 3) Press ▲▼ to select [EMULATE].
- 4) Press the <ENTER> button.
  - The [EMULATE] screen is displayed.
- 5) Press ▲▼ to select an item.

[DEFAULT]	EZ590 series, EW650 series, EW550 series, EX620 series, EX520 series, FZ570 series, FW530 series, FX500 series, VW355N series, VX425N series, VW350 series, VX420 series, VZ575N series, VW535N series, VX605N series, VZ570 series, VW530 series, VX600 series, VX60, VX50, EZ580 series, EW640 series, EX610 series, EW540 series, EX510 series, VW345N series, VX415N series, VW340Z, VX410Z, VX42Z, VX406EA, VX46EA, EZ770 series, EW730 series, EX800 series, RZ475 series, RZ470 series, RW430 series, RZ370 series, RW330 series
[D3500]	D3500 series
[D4000]	D4000 series
[D/W5k SERIES]	D5700 series, DW5100 series, D5600 series, DW5000 series, D5500 series
[D/W/Z6k SERIES]	DZ770 series, DW740 series, DX810 series, DZ680 series, DW640 series, DX610 series, DW730 series, DX800 series, DZ6710 series, DZ6700 series, DW6300 series, D6000 series, D5000 series, DZ570 series, DW530 series, DX500 series, RZ570 series
[L730 SERIES]	L730 series, L720 series, L520 series
[L780 SERIES]	L780 series, L750 series
[L735 SERIES]	L735 series
[L785 SERIES]	L785 series
[F/W SERIES]	FW430 series, FX400 series, FW300 series, F300 series, F200 series, FW100 series, F100 series
[LZ370]	LZ370 series
[LB/W SERIES]	LB3 series, LB2 series, LB1 series, ST10 series, LB90 series, LW80NT series, LB80 series, LB78 series, LB75 series
[VX500 SERIES]	VW435N series, VW440 series, VW430 series, VX505N series, VX510 series, VX501U, VX405KEA, VX45KEA, VX500 series, VW330 series, VX400NT series, VX400 series, VX41 series
[EZ570 SERIES]	EZ570 series, EW630 series, EW530 series, EX600 series, EX500 series
[VW431D]	VW431D series

- 6) Press the <ENTER> button.

#### Note

(Only for PT-EZ590, PT-EW650 and PT-EX620)

- When [INPUT SELECT] is set to [DIGITAL LINK], communication using that serial terminal is available only when the corresponding device (such as the optional DIGITAL LINK output supported device (Model No.: ET-YFB100G, ET-YFB200G)) is connected to the <DIGITAL LINK/LAN> terminal.
- When transferring logos via the optional DIGITAL LINK output supported device (Model No.: ET-YFB100G, ET-YFB200G), setting for "NO SIGNAL SLEEP" of the DIGITAL LINK output supported device should be set to "OFF" to avoid interruption of communication.
- When [INPUT SELECT] is set to [DIGITAL LINK], communication speed is fixed to 9 600 bps.

### [REMOTE1 MODE]

Set the <REMOTE 1 IN> terminal.

- 1) Press ▲▼ to select [REMOTE1 MODE].
- 2) Press ◀▶ to switch the item.
  - The items will switch each time you press the button.

[DEFAULT]	The pin assignment of the <REMOTE 1 IN> terminal is used by the factory default setting of the projector.
[USER]	Used to change the setting of the <REMOTE 1 IN> terminal.
[F/W SERIES]	The setting of the <REMOTE 1 IN> terminal is used for the F/W series compatibility.

- When [USER] is selected, proceed to Step 3).

- 3) Press the <ENTER> button.
- 4) Press ▲▼ to select one from [PIN2] to [PIN8], and press ◀▶ to switch the setting.

### [FUNCTION BUTTON]

The function assigned to the <FUNCTION> button of the remote control is displayed. You can also release the assigned setting.

## Releasing assigned function to the <FUNCTION> button

- 1) Press ▲▼ to select [FUNCTION BUTTON].
- 2) Press the <ENTER> button.
  - The [FUNCTION BUTTON] screen is displayed.
- 3) Press the <ENTER> button.
- 4) When the confirmation screen is displayed, press ◀▶ to select [OK] and press the <ENTER> button.

### Note

- You can also cancel the assigned settings by displaying the on-screen menu, selecting the menu item to be canceled (main menu, submenu, or details menu), and then pressing the <FUNCTION> button for at least 3 seconds.

## [AUDIO SETTING]

You can perform more detailed setting for Audio.

### Adjusting the volume

- 1) Press ▲▼ to select [AUDIO SETTING].
- 2) Press the <ENTER> button.
  - The [AUDIO SETTING] screen is displayed.
- 3) Press ▲▼ to select [VOLUME].
- 4) Press ◀▶ to adjust the level.

Operation	Adjustment	Range
Press the ▶ button.	Increases the volume.	0 ~ 63
Press the ◀ button.	Decreases the volume.	

### Adjusting the left to right audio balance

- 1) Press ▲▼ to select [AUDIO SETTING].
- 2) Press the <ENTER> button.
  - The [AUDIO SETTING] screen is displayed.
- 3) Press ▲▼ to select [BALANCE].
- 4) Press ◀▶ to adjust the level.

Operation	Adjustment	Range of adjustment
Press the ▶ button.	Increases the volume on the right.	L16 ~ R16
Press the ◀ button.	Increases the volume on the left.	

### Setting audio output of the built-in speaker

- 1) Press ▲▼ to select [AUDIO SETTING].
- 2) Press the <ENTER> button.
  - The [AUDIO SETTING] screen is displayed.
- 3) Press ▲▼ to select [BUILT-IN SP].
- 4) Press ◀▶ to switch the item.
  - The items will switch each time you press the button.

[ON]	Audio is output from the built-in speaker.
[OFF]	Audio is not output from the built-in speaker.

**Note**

- Audio is output from the built-in speaker even if the cable is connected to the <VARIABLE AUDIO OUT> terminal. To output audio from external audio devices connected to the <VARIABLE AUDIO OUT> terminal and not from the built-in speaker, set [BUILT-IN SP] to [OFF].

**Setting the audio output during standby**

- 1) Press ▲▼ to select [AUDIO SETTING].
- 2) Press the <ENTER> button.
  - The [AUDIO SETTING] screen is displayed.
- 3) Press ▲▼ to select [IN STANDBY MODE].
- 4) Press ◀▶ to switch the item.
  - The items will switch each time you press the button.

[OFF]	Disables audio output in the standby mode.
[ON]	Enables audio output in the standby mode when [STANDBY MODE] is set to [NORMAL]. At this time, press the <VOL-> button/<VOL+> button on the remote control or the control panel to adjust the volume.

**Note**

- When [ECO MANAGEMENT] → [STANDBY MODE] is set to [ECO] (➔ page 95), even if [IN STANDBY MODE] is set to [ON], audio cannot be output during standby.
- When [NETWORK] input is selected, even if [IN STANDBY MODE] is set to [ON], audio cannot be output during standby.
- When [IN STANDBY MODE] is set to [ON] and the digital signal is input, the audio output is interrupted during the cooling period after the power is turned off, but this is not a malfunction.

**Setting the mute**

- 1) Press ▲▼ to select [AUDIO SETTING].
- 2) Press the <ENTER> button.
  - The [AUDIO SETTING] screen is displayed.
- 3) Press ▲▼ to select [MUTE].
- 4) Press ◀▶ to switch the item.
  - The items will switch each time you press the button.

[OFF]	Audio is output.
[ON]	Audio is not output.

**Setting audio input selection**

Choose the audio input terminal for each input signal.

- 1) Press ▲▼ to select [AUDIO SETTING].
- 2) Press the <ENTER> button.
  - The [AUDIO SETTING] screen is displayed.
- 3) Press ▲▼ to select one item of [AUDIO IN SELECT].

[RGB1]	Set the audio output when [RGB1] input is selected.
[RGB2]	Set the audio output when [RGB2] input is selected.
[VIDEO]	Set the audio output when [VIDEO] input is selected.
[HDMI1]	Set the audio output when [HDMI1] input is selected.
[HDMI2]	Set the audio output when [HDMI2] input is selected.
[DIGITAL LINK]*1	Set the audio output when [DIGITAL LINK] input is selected.
[NETWORK]	Set the audio output when [NETWORK] input is selected.

\*1 Only for PT-EZ590, PT-EW650 and PT-EX620

- 4) Press ◀▶ to switch the item.

- The sub items will switch each time you press the button.

[RGB1]	Select one item among [AUDIO IN 1], [AUDIO IN 2] or [AUDIO IN 3].
[RGB2]	Select one item among [AUDIO IN 1], [AUDIO IN 2] or [AUDIO IN 3].
[VIDEO]	Select one item among [AUDIO IN 1], [AUDIO IN 2] or [AUDIO IN 3].
[HDMI1]	Select one item among [HDMI1 AUDIO IN], [AUDIO IN 1], [AUDIO IN 2] or [AUDIO IN 3].
[HDMI2]	Select one item among [HDMI2 AUDIO IN], [AUDIO IN 1], [AUDIO IN 2] or [AUDIO IN 3].
[DIGITAL LINK]*1	Select one item among [DIGITAL LINK AUDIO IN], [AUDIO IN 1], [AUDIO IN 2] or [AUDIO IN 3].
[NETWORK]	Select one item among [NETWORK AUDIO IN], [AUDIO IN 1], [AUDIO IN 2] or [AUDIO IN 3].

\*1 Only for PT-EZ590, PT-EW650 and PT-EX620

## [TEST PATTERN]

Displays the test pattern built-in to the projector.

Settings of position, size, and other factors will not be reflected in test patterns. Make sure to display the input signal before performing various adjustments.

- 1) Press ▲▼ to select [TEST PATTERN].
- 2) Press the <ENTER> button.
  - The test pattern with the [PATTERN CHANGE] individual adjustment screen is displayed.
- 3) Press ◀▶ to switch the test pattern.
  - The test pattern will switch each time you press the button.
  - When you press the <MENU> button or the <RETURN> button, it will exit the test pattern and return to the sub menu of [PROJECTOR SETUP].

All white	Select a test pattern so that it is easy to make various adjustments.
Color bars (vertical)	
Color bars (horizontal)	
16 gradations (vertical 1)	
16 gradations (vertical 2)	
16 gradations (horizontal 1)	
16 gradations (horizontal 2)	
White cross on the black background	
Black cross on the white background	
Cross hatch	

### Note

- The initial setting is All white. The initial screen is Cross hatch if you have assigned it to the <FUNCTION> button.
- Press the <ON SCREEN> button on the remote control while the test pattern is displayed to hide the menu screen.

## [FILTER COUNTER]

You can check the filter usage time and set the cleaning cycle for the air filter. Also, reset the filter usage time.

- 1) Press ▲▼ to select [FILTER COUNTER].
- 2) Press the <ENTER> button.
  - The [FILTER COUNTER] screen is displayed.

[FILTER COUNTER]	Displays the using time of the filter.
[TIMER]	Sets the cleaning cycle (time) for the air filter.
[FILTER COUNTER RESET]	Resets the filter usage time.

### Setting [TIMER]

Sets the cleaning cycle (time) if you want to clean the air filter periodically. When the time reaches, an alert message "FILTER COUNTER has reached the set time." for filter cleaning is displayed on the projected screen.

- 1) Press ▲▼ to select [FILTER COUNTER].
- 2) Press the <ENTER> button.
  - The [FILTER COUNTER] screen is displayed.
- 3) Press ▲▼ to select [TIMER].
- 4) Press ◀▶ to switch the setting of the timer.
  - The items will switch each time you press the button.

[OFF]	Sets when you do not want to display the set time reaching alert message.
[1000 H] ~ [15000 H]	Sets the timer in 1 000 hour increments from 1 000 to 15 000 hours.

### Resetting [FILTER COUNTER]

- 1) Press ▲▼ to select [FILTER COUNTER].
- 2) Press the <ENTER> button.
  - The [FILTER COUNTER] screen is displayed.
- 3) Press ▲▼ to select [FILTER COUNTER RESET].
- 4) Press the <ENTER> button.
  - The [FILTER COUNTER RESET] screen is displayed.
- 5) Press ◀▶ to select [OK] and then press the <ENTER> button.

### [SCHEDULE]

Set the command execution schedule for each day of the week.

#### Enable/Disable the schedule function

- 1) Press ▲▼ to select [SCHEDULE].
- 2) Press ◀▶ to switch the item.
  - The items will switch each time you press the button.

[OFF]	Disables the schedule function.
[ON]	Enables the schedule function. Refer to “How to assign a program” (➔ page 101) or “How to set a program” (➔ page 101) for how to set the schedule.

#### Note

- When [SCHEDULE] is set to [ON], the [STANDBY MODE] setting is forcibly switched to [NORMAL], and the setting cannot be changed. Even if [SCHEDULE] is then set to [OFF] when in this state, the setting of [STANDBY MODE] remains at [NORMAL].

#### How to assign a program

- 1) Press ▲▼ to select [SCHEDULE].
- 2) Press ◀▶ to select [ON], and press the <ENTER> button.
  - The [SCHEDULE] screen is displayed.
- 3) Select and assign program to each day of week.
  - Press ▲▼ to select the day of week, and press ◀▶ to select a program number.
  - You can set the program from No.1 to No.7. “- - -” indicates that the program number has not been set.

#### How to set a program

Set up to 16 commands to each program.

- 1) Press ▲▼ to select [SCHEDULE].
- 2) Press ◀▶ to select [ON], and press the <ENTER> button.

- The [SCHEDULE] screen is displayed.
- 3) Press ▲▼ to select [PROGRAM EDIT].
  - 4) Press ◀▶ to select a program number, and press the <ENTER> button.
  - 5) Press ▲▼ to select a command number, and press the <ENTER> button.
  - 6) Press ▲▼◀▶ to select [TIME], and press the <ENTER> button.
    - The projector is in the adjustment mode (where the time is blinking).
  - 7) Press ◀▶ to select “hour” or “minute”, and press ▲▼ to set a time, and then press the <ENTER> button.
  - 8) Press ▲▼◀▶ to select [COMMAND].
  - 9) Press the <ENTER> button.
    - The [COMMAND] detailed screen is displayed.
  - 10) Press ▲▼ to select a [COMMAND].
    - For [COMMAND] which requires detailed settings, the items of the detailed settings will switch each time you press ◀▶.
    - When [INPUT] is selected, press the <ENTER> button, and then press ▲▼ to select the input to be set.

[COMMAND]	Detailed settings of [COMMAND]	Description
[POWER ON]	—	Switches on the projector.
[STANDBY]	—	Enters standby.
[SHUTTER] *1	[OPEN]	Disables the shutter function (shutter: open).
	[CLOSE]	Enables the shutter function (shutter: closed).
[AV MUTE] *2	[OFF]	Cancels the AV mute.
	[ON]	The image and the audio disappear.
[INPUT]	[NETWORK]	Switches the input to NETWORK.
	[RGB1]	Switches the input to RGB1.
	[RGB2]	Switches the input to RGB2.
	[HDMI1]	Switches the input to HDMI1.
	[HDMI2]	Switches the input to HDMI2.
	[VIDEO]	Switches the input to VIDEO.
	[DIGITAL LINK]*1	Switches the input to DIGITAL LINK.
[INPUT1] - [INPUT10]*3	Switches the input to DIGITAL LINK, and switch the input of the Panasonic twisted-pair-cable transmitter to the specified input.	
[LAMP POWER]	[NORMAL]	Sets the lamp brightness to high luminance.
	[ECO]	Sets the lamp brightness to low luminance.
[IN STANDBY MODE]	[OFF]	Audio output is stopped during standby.
	[ON]	Audio is output during standby.
[VOLUME]	[0] ~ [63]	Sets the volume.

\*1 For PT-EZ590, PT-EW650 and PT-EX620

\*2 For PT-EW550 and PT-EX520

\*3 When the optional DIGITAL LINK output supported device (Model No.: ET-YFB100G, ET-YFB200G) is connected to the projector, its input name is automatically reflected from [INPUT1] to [INPUT10]. If an item where the input name is not reflected is selected, it is disabled.

- 11) Press the <ENTER> button.
  - The command is fixed and ● is displayed at the left of the selected command.
- 12) Press ▲▼◀▶ to select [STORE], and press the <ENTER> button.

### Note

- If you attempt to register the setting that would make the lamp turn on for a short time, an error message will be displayed on the screen. Set the time and the command again.
- To delete a command that has been already set, press the <DEFAULT> button on the remote control while the screen in Step 5) is displayed, or select [DELETE] at the screen in Step 6) and press the <ENTER> button.
- If multiple commands have been set for the same time, they are executed in chronological order starting from the smallest command number.
- The operating time will be the local time. (➔ page 103)

- If an operation is executed with the remote control or the control panel of the projector or with a control command before the command set in [SCHEDULE] is executed, the command set with the schedule function may not be executed.

## [DATE AND TIME]

Set the time zone, date, and time of the built-in clock of the projector.

### Setting the time zone

- 1) Press ▲▼ to select [DATE AND TIME].
- 2) Press the <ENTER> button.
  - The [DATE AND TIME] screen is displayed.
- 3) Press ▲▼ to select [TIME ZONE].
- 4) Press ◀▶ to switch [TIME ZONE].

### Setting the date and time manually

- 1) Press ▲▼ to select [DATE AND TIME].
- 2) Press the <ENTER> button.
  - The [DATE AND TIME] screen is displayed.
- 3) Press ▲▼ to select [ADJUST CLOCK].
- 4) Press the <ENTER> button.
  - The [ADJUST CLOCK] screen is displayed.
- 5) Press ▲▼ to select an item, and press ◀▶ to set the local date and time.
- 6) Press ▲▼ to select [OK], and press the <ENTER> button.
  - The setting of the date and time will be completed.

### Setting the date and time automatically

- 1) Press ▲▼ to select [DATE AND TIME].
- 2) Press the <ENTER> button.
  - The [DATE AND TIME] screen is displayed.
- 3) Press ▲▼ to select [ADJUST CLOCK].
- 4) Press the <ENTER> button.
  - The [ADJUST CLOCK] screen is displayed.
- 5) Press ▲▼ to select [NTP SYNCHRONIZATION], and press ◀▶ to change the setting to [ON].
- 6) Press ▲▼ to select [OK], and press the <ENTER> button.
  - The setting of the date and time will be completed.

#### Note

- To set the date and the time automatically, the projector must be connected to the network.
- If synchronization with the NTP server fails just after [NTP SYNCHRONIZATION] is turned [ON], [NTP SYNCHRONIZATION] will return to [OFF]. Also if [NTP SYNCHRONIZATION] is turned [ON] while the NTP server is not set, [NTP SYNCHRONIZATION] will return to [OFF].
- Access the projector via a web browser to set the NTP server. Refer to "[Adjust clock] page" (➔ page 131) for details.
- The [TIME ZONE] setting is reset to the factory default when [INITIALIZE ALL] is executed from the [PROJECTOR SETUP] menu (➔ page 104). However, the date and the time based on the local date and the time setting (Coordinated Universal Time, UTC, Universal Time, Coordinated) will be maintained without being initialized.

## [LENS CALIBRATION]

Detect the lens shift limit value of the projector and set the home position automatically.

- 1) Press ▲▼ to select [LENS CALIBRATION].

- 2) **Press the <ENTER> button.**
  - The confirmation screen is displayed.
- 3) **Press ◀▶ to select [OK], and press the <ENTER> button.**
  - To cancel, select [CANCEL].
  - The lens moves up, down, left, and right to automatically detect the lens shift limit value, and automatically set the home position.
  - The lens stops to complete the calibration.

---

**Note**

- [NOW CALIBRATING...] is displayed during lens calibration. Cannot cancel mid-operation.
- When lens calibration executes correctly, [COMPLETE] is displayed and [INCOMPLETE] is displayed when it does not execute correctly.

---

**[INITIALIZE ALL]**

---

Return various setting values to their factory default settings.

- 1) **Press ▲▼ to select [INITIALIZE ALL].**
- 2) **Press the <ENTER> button.**
  - The [INITIALIZE ALL] screen is displayed.
- 3) **When the confirmation screen is displayed, press ◀▶ to select [OK] and then press the <ENTER> button.**
  - The [NOW INITIALIZING...] screen is displayed and then the [POWER OFF.] screen will be displayed.
- 4) **Press the <ENTER> button.**
  - The operation of other buttons is disabled.
  - The focus adjustment screen and the initial setting (display language) screen will be displayed successively when the projector is switched on the next time.

---

**Note**

- The projector will enter the standby status to reflect the setting values when [INITIALIZE ALL] is executed.
- When [INITIALIZE ALL] is executed, [STANDBY MODE], [EMULATE], [FILTER COUNTER] and the setting values of [NETWORK] cannot be returned to the factory default values.  
For details about the initialization of [NETWORK], please refer to [NETWORK] → [INITIALIZE]. (➡ page 111)

---

**[SERVICE PASSWORD]**

---

This function is used by a service person.



## [SECURITY] menu

On the menu screen, select [SECURITY] from the main menu, and select an item from the sub-menu. Refer to “Navigating through the menu” (➔ page 63) for the operation of the menu screen.

- When the projector is used for the first time  
Initial password: Press ▲▶▼◀◀▶▶▼◀ in order, and press the <ENTER> button.

### Attention

- When you select the [SECURITY] menu and press the <ENTER> button, entering a password is required. Enter the preset password and then continue operations of the [SECURITY] menu.
- When the password has been changed previously, enter the changed password, and press the <ENTER> button.

### Note

- The entered password is displayed with \* marks on the screen.
- An error message is displayed on the screen when the entered password is incorrect. Re-enter the correct password.

## [PASSWORD]

The [PASSWORD] screen is displayed when turning the <MAIN POWER> switch to <OFF> and turning on the power. When the entered password is incorrect, the operation will be restricted to the power <⏻/|> button and the <LENS> (<FOCUS>, <ZOOM> and <SHIFT>) buttons.

- 1) Press ▲▼ to select [PASSWORD].
- 2) Press ◀▶ to switch the item.
  - The items will switch each time you press the button.

[OFF]	Disables the security password entry.
[ON]	Enables the security password entry.

### Note

- The [PASSWORD] setting is set to [OFF] by the factory default or when [INITIALIZE ALL] in [PROJECTOR SETUP] menu (➔ page 104) is executed.
- Change the password periodically that is hard to guess.
- The security password is enabled after setting [PASSWORD] to [ON] and turning the <MAIN POWER> switch to <OFF>.

## [PASSWORD CHANGE]

Change the security password.

- 1) Press ▲▼ to select [PASSWORD CHANGE].
- 2) Press the <ENTER> button.
  - The [PASSWORD CHANGE] screen is displayed.
- 3) Press ▲▼◀▶ and the number (<0> - <9>) buttons to set the password.
  - Up to eight button operations can be set.
- 4) Press the <ENTER> button.
- 5) Re-enter the password for the confirmation.
- 6) Press the <ENTER> button.

### Note

- The entered password is displayed with \* marks on the screen.
- An error message is displayed on the screen when the entered password is incorrect. Re-enter the correct password.
- If numbers have been used for the security password, the security password will need to be initialized again if the remote control is lost. Consult your dealer for the initialization method.

## [DISPLAY SETTING]

Overlap the security message (text or image) over the projecting image.

- 1) Press ▲▼ to select [DISPLAY SETTING].
- 2) Press ◀▶ to switch the item.

- The items will switch each time you press the button.

[OFF]	Hides the security message.
[TEXT]	Displays the text set in the [SECURITY] menu → [TEXT CHANGE].
[USER LOGO]	Displays the image registered by the user.

### Note

- To create/register the [USER LOGO] image, use “Logo Transfer Software” included in the supplied CD-ROM.

## [TEXT CHANGE]

Edit the text to be displayed when [TEXT] is selected in [DISPLAY SETTING].

- 1) Press **▲▼** to select [TEXT CHANGE].
- 2) Press the **<ENTER>** button.
  - The [TEXT CHANGE] screen is displayed.
- 3) Press **▲▼◀▶** to select the text, and press the **<ENTER>** button to enter the text.
- 4) Press **▲▼◀▶** to select [OK], and press the **<ENTER>** button.
  - The text is changed.

## [MENU LOCK]

Display the menu by the <MENU> button and set whether or not to enable menu operations.

- 1) Press **▲▼** to select [MENU LOCK].
- 2) Press **◀▶** to switch the item.
  - The items will switch each time you press the button.

[OFF]	Unlocks menu operations.
[ON]	Locks menu operations.

### Note

- When the entered password is incorrect after setting [MENU LOCK] to [ON], the <MENU> button cannot be operated.
- [MENU LOCK] is set to [OFF] at the time of purchase or when [INITIALIZE ALL] is executed.
- When [MENU LOCK] is set to [ON], after entering the password to release the lock, the unlock state is held until the projector enters the standby mode.

## [MENU LOCK PASSWORD]

The menu lock password can be changed.

- 1) Press **▲▼** to select [MENU LOCK PASSWORD].
- 2) Press the **<ENTER>** button.
  - The [MENU LOCK PASSWORD] screen is displayed.
- 3) Press **▲▼◀▶** to select the text, and press the **<ENTER>** button to enter the text.
  - Up to 16 characters can be input.
- 4) Press **▲▼◀▶** to select [OK], and press the **<ENTER>** button.
  - To cancel, select [CANCEL].

### Attention

- The initial password is “AAAA” at the time of purchase or when [INITIALIZE ALL] is executed.
- Change the password periodically that is hard to guess.

## [CONTROL DEVICE SETUP]

Enable/disable the button operations on the control panel and the remote control.

- 1) Press **▲▼** to select [CONTROL DEVICE SETUP].

2) Press the <ENTER> button.

- The [CONTROL DEVICE SETUP] screen is displayed.

3) Press ▲▼ to select [CONTROL PANEL] or [REMOTE CONTROLLER].

[CONTROL PANEL]	You can set the limitation on the control from the control panel.
[REMOTE CONTROLLER]	You can set the limitation on the control from the remote control.

4) Press ◀▶ to switch between [ENABLE] and [DISABLE].

- You can set the limitation on the control by the control panel or the remote control.

[ENABLE]	Enable the button operations.
[DISABLE]	Disable the button operations.

- A confirmation screen will be displayed when you change [ENABLE] to [DISABLE], then proceed to Step 5).

5) Press ◀▶ to select [OK], and then press the <ENTER> button.

**Note**

- When a button operation is performed on the device set to [DISABLE] , the [PASSWORD] screen is displayed. To continue operations, enter the security password.
- The [PASSWORD] screen will disappear when there is no operation for approx. 10 seconds.
- If the operations of both [CONTROL PANEL] and [REMOTE CONTROLLER] are set to [DISABLE], the projector cannot be turned off (cannot enter standby).
- Even when you set button operations on the remote control to be disabled, operations of the <ID ALL> and <ID SET> buttons on the remote control are enabled.

## [NETWORK] menu

On the menu screen, select [NETWORK] from the main menu, and select an item from the sub-menu. Refer to “Navigating through the menu” (➔ page 63) for the operation of the menu screen.

### Note

- The on-screen menu (menu screen) of the projector has not the network setting about the wireless LAN. When the wireless module (Model No.: ET-WML100) of the optional accessories is inserted to the projector, please set the wireless LAN by accessing the projector via a computer. For detailed, please refer to “Web control function” → “[Network config] page” → “Wireless LAN” (➔ page 127).

### [DIGITAL LINK MODE]

(Only for PT-EZ590, PT-EW650 and PT-EX620)

Switch the communication method of the <DIGITAL LINK/LAN> terminal of the projector.

- Press ▲▼ to select [DIGITAL LINK MODE].
- Press ◀▶ to switch the item.
  - The items will switch each time you press the button.

[AUTO]	Switches the communication method automatically to DIGITAL LINK, long reach or Ethernet.
[DIGITAL LINK]	Fixes the communication method to DIGITAL LINK.
[LONG REACH]	Fixes the communication method to long reach.
[ETHERNET]	Fixes the communication method to Ethernet.

### Possible communication modes

- ✓: Communication possible  
—: Communication not possible

Setting		Communication possible			
		Image transmission (100 m (328'1"))	Image transmission (150 m (492'2"))	Ethernet	RS-232C
[AUTO]	For DIGITAL LINK	✓	—	✓	✓
	For long reach	—	✓	✓	✓
	For Ethernet	—	—	✓	—
[DIGITAL LINK]		✓	—	✓	✓
[LONG REACH]		—	✓	✓	✓
[ETHERNET]		—	—	✓	—

### Note

- The maximum transmission distance when connected with the long-reach communication method is 150 m (492'2"). However, the signal that the projector can receive is only up to 1080/60p (1 920 x 1 080 dots, dot clock frequency: 148.5 MHz).
- When the communication method of the twist-pair-cable transmitter is set to long reach, it will connect with long-reach communication method when [DIGITAL LINK MODE] is set to [AUTO]. To connect with the optional DIGITAL LINK Switcher (Model No.: ET-YFB200G) with the long-reach communication method, set [DIGITAL LINK MODE] to [LONG REACH].
- It will not connect correctly if the twist-pair-cable transmitter is not supporting the long-reach communication method even if [DIGITAL LINK MODE] is set to [LONG REACH].

### [DIGITAL LINK STATUS]

(Only for PT-EZ590, PT-EW650 and PT-EX620)

Display DIGITAL LINK connection environment.

- Press ▲▼ to select [DIGITAL LINK STATUS].
- Press the <ENTER> button.
  - The [DIGITAL LINK STATUS] screen is displayed.

[LINK STATUS]	Either [NO LINK], [DIGITAL LINK], [LONG REACH] or [ETHERNET] is displayed.
[HDCP STATUS]	Either [NO SIGNAL], [OFF], or [ON] is displayed.

<b>[SIGNAL QUALITY]</b>	<p>[SIGNAL QUALITY] is a numerical value of the amount of error, and the display color changes to green, yellow, or red depending on that value. Check the signal quality level while receiving a signal from the twisted-pair-cable transmitter.</p> <ul style="list-style-type: none"> <li>• MAX/MIN: Maximum/minimum value of the amount of error.</li> <li>• Green (–12 dB or lower) → Normal signal quality level.</li> <li>• Yellow (–11 to –8 dB) → Warning level where there is the possibility of noise introduced on the screen.</li> <li>• Red (–7 dB or higher) → Abnormal level where synchronization may be interrupted or a signal may not be received.</li> </ul>
-------------------------	---

## [DIGITAL LINK MENU]

(Only for PT-EZ590, PT-EW650 and PT-EX620)

When the optional DIGITAL LINK output supported device (Model No.: ET-YFB100G, ET-YFB200G) is connected to the <DIGITAL LINK/LAN> terminal, the main menu of DIGITAL LINK output supported device is displayed.

Refer to the Operating Instructions of the DIGITAL LINK output supported device for details.

### Note

- When [NETWORK] menu → [NETWORK CONTROL] → [EXTRON XTP] is set to [ON], [DIGITAL LINK MENU] cannot be selected.

## [WIRED LAN]

You can make detailed wired LAN settings.

- 1) Press ▲▼ to select [WIRED LAN].
- 2) Press the <ENTER> button.
  - The [WIRED DETAILED SETUP] screen is displayed.
- 3) Press ▲▼ to select an item, and change the setting according to the instructions.

<b>[DHCP]</b>	<b>[ON]</b>	If a DHCP server exists in the network to which the projector is connected, the IP address will automatically be acquired.
	<b>[OFF]</b>	If a DHCP server does not exist in the network to which the projector is connected, additionally set [IP ADDRESS], [SUBNET MASK] and [DEFAULT GATEWAY].
<b>[IP ADDRESS]</b>	Enter the IP address if DHCP server is not used.	
<b>[SUBNET MASK]</b>	Enter the subnet mask if DHCP server is not used.	
<b>[DEFAULT GATEWAY]</b>	Enter the gateway address if DHCP server is not used.	
<b>[DNS1]</b>	Enter the preferred DNS server address if DHCP server is not used.	
<b>[DNS2]</b>	Enter the alternate DNS server address if DHCP server is not used.	

- 4) Press ▲▼ to select [OK], and press the <ENTER> button.

### ■ Default settings of [WIRED LAN]

- The following settings are set before the projector leaves the factory.

<b>[DHCP]</b>	OFF
<b>[IP ADDRESS]</b>	192.168.10.100
<b>[SUBNET MASK]</b>	255.255.255.0
<b>[DEFAULT GATEWAY]</b>	192.168.10.1
<b>[DNS1]/[DNS2]</b>	NONE

### Note

- Before using the DHCP server, make sure the DHCP server is already functioning.
- Consult your network administrator regarding the IP ADDRESS, SUBNET MASK and DEFAULT GATEWAY.
- The settings of network are same for both the <LAN> terminal and the <DIGITAL LINK/LAN> terminal.

## [PROJECTOR NAME]

Change the name as desired in such a case as the projector needs to be identified on application software.

- 1) Press ▲▼ to select [PROJECTOR NAME].

- 2) Press the <ENTER> button.
  - The [PROJECTOR NAME] screen is displayed.
- 3) Select characters with the ▲▼◀▶ buttons and press the <ENTER> button to enter the projector name.
  - Up to eight characters can be input.
  - Select [ALL DELETE] to delete all the entered characters, or press the <DEFAULT> button on the remote control to delete a character on the cursor in the entry field.
- 4) Select [OK] with the ▲▼ buttons and press the <ENTER> button.
  - To cancel the change of the name, press ▲▼◀▶ to select [CANCEL] and press the <ENTER> button.

#### Note

- [Name □□□□] (□□□□ is 4-digit number) is set before the projector leaves the factory.

## [NETWORK CONTROL]

Set up the control method of the network.

- 1) Press ▲▼ to select [NETWORK CONTROL].
- 2) Press the <ENTER> button.
  - The [NETWORK CONTROL] screen is displayed.
- 3) Press ▲▼ to select an item, and press ◀▶ to change the setting.

[WEB CONTROL]	Set to [ON] to control with the web browser.
[PJLink CONTROL]	Set to [ON] to control with the PJLink protocol.
[COMMAND CONTROL]	Set to [ON] to control with the <SERIAL IN> terminal control command format (➔ page 152). Refer to "Control commands via LAN" (➔ page 149).
[COMMAND PORT]	Set the port number used for command control.
[Crestron Connected(TM)]	Set to [ON] to control with Crestron Connected™ of Crestron Electronics, Inc.
[AMX D.D.]	Set to [ON] to control with the controller of AMX Corporation. Setting this function to [ON] enables detection through "AMX Device Discovery". For details, refer to the website of AMX Corporation. URL <a href="http://www.amx.com/">http://www.amx.com/</a>
[EXTRON XTP] *1	Set to [ON] when connecting the "XTP transmitter" of Extron Electronics to the <DIGITAL LINK/LAN> terminal. The [EXTRON XTP] setting must be set to [OFF] when connecting the optional DIGITAL LINK output supported device (Model No.: ET-YFB100G, ET-YFB200G). For details of the "XTP transmitter", refer to the website of Extron Electronics. URL <a href="http://www.extron.com/">http://www.extron.com/</a>

\*1 Only for PT-EZ590, PT-EW650 and PT-EX620

- 4) Press ▲▼ to select [OK], and press the <ENTER> button.
  - The current network control settings is saved.

## [NETWORK STATUS]

Display the status of the projector network.

- 1) Press ▲▼ to select [NETWORK STATUS].
- 2) Press the <ENTER> button.
  - The [NETWORK STATUS] screen is displayed.
  - The display screen (1/2 [WIRED LAN] → 2/2 [WIRELESS LAN]/[Presenter Light]) will change each time you press ▲▼.

[WIRED LAN]	[DHCP]	Displays the usage state of the DHCP server.
	[IP ADDRESS]	Displays the IP address.
	[SUBNET MASK]	Displays the subnet mask.
	[DEFAULT GATEWAY]	Displays the default gateway.
	[DNS1]	Displays the address of the preferred DNS server.
	[DNS2]	Displays the address of the alternate DNS server.
	[MAC ADDRESS]	Displays the MAC address.

[WIRELESS LAN]	[SSID] <sup>*1</sup>	Displays the character string of SSID.
	[IP ADDRESS] <sup>*1</sup>	Displays the IP address.
[Presenter Light]	[LOGIN PASSWORD]	Displays the login password for Presenter Light/VueMagic used.

\*1 The [SSID]/[IP ADDRESS] of [WIRELESS LAN] will be displayed when the wireless module (Model No.: ET-WML100) of the optional accessories is inserted.

### Note

- The settings of network are same for both the <LAN> terminal and the <DIGITAL LINK/LAN> terminal.
- The on-screen menu (menu screen) of the projector has not the network setting about the wireless LAN. When the wireless module (Model No.: ET-WML100) of the optional accessories is inserted to the projector, please set the wireless LAN by accessing the projector via a computer. For details, please refer to "Web control function" → "[Network config] page" → "Wireless LAN" (➡ page 127).

### [INITIALIZE]

This function is used to return various setting values of [NETWORK] to the factory default value.

- 1) Press ▲▼ to select [INITIALIZE].
- 2) Press the <ENTER> button.
  - The [INITIALIZE] screen is displayed.
- 3) Press ◀▶ to select [OK] and then press the <ENTER> button.

# Chapter 5 Operation of Function

---

This chapter describes the operation methods of some functions.



# Network connections

This projector has network function that allows the following by connecting a computer. The wireless module (Model No.: ET-WML100) of the optional accessories is required if the wireless LAN is connected.

- **WEB control**

By accessing the projector from a computer, you can perform setting, adjustment, status display, etc. of the projector. Refer to “Web control function” (➔ page 120) for details.

- **Multi Monitoring & Control Software**

This software allows you to monitor and control multiple displays (projector or flat panel display) connected to the LAN. For details, please refer to the operating instructions for “Multi Monitoring & Control Software” included in the supplied CD-ROM.

- **Early Warning Software**

The projector supports “Early Warning Software”, which monitors the status of the display (projector or flat panel display) and the peripheral devices inside an intranet, and notifies of abnormality of such equipment and detects signs of possible abnormality. For details, please visit the Panasonic website (<https://panasonic.net/cns/projector/pass/>).

- **Presenter Light**

By using image transfer application software “Presenter Light” that supports Windows computers, you can transfer images and audio to the projector via the wired LAN/wireless LAN. For details, please refer to the operating instructions for “Presenter Light” included in the supplied CD-ROM.

- **VueMagic**

By using still image transfer application software “VueMagic”, you can transfer images to the projector when iPad/iPhone/iPod touch or Android terminals are connected to this projector through the wireless LAN. Refer to “About VueMagic” (➔ page 119) for details.

- **PJLink**

By using PJLink protocol, you can send inquiries about the operations or status of the projector from a computer. Refer to “PJLink protocol” (➔ page 148) for details.

## When connecting via wired LAN

The projector is equipped with a normal <LAN> terminal and a <DIGITAL LINK/LAN> terminal that can receive Ethernet signals from a twisted-pair-cable transmitter together with video and audio signals via a LAN cable.

- When you do not need to connect a twisted-pair-cable transmitter, connect to the <LAN> terminal or the <DIGITAL LINK/LAN> terminal.
- When you need to connect a twisted-pair-cable transmitter that does not support Ethernet signals, connect to the <LAN> terminal.
- When you need to receive Ethernet signals from a twisted-pair-cable transmitter, connect to the <DIGITAL LINK/LAN> terminal.

## Example of a normal network connection

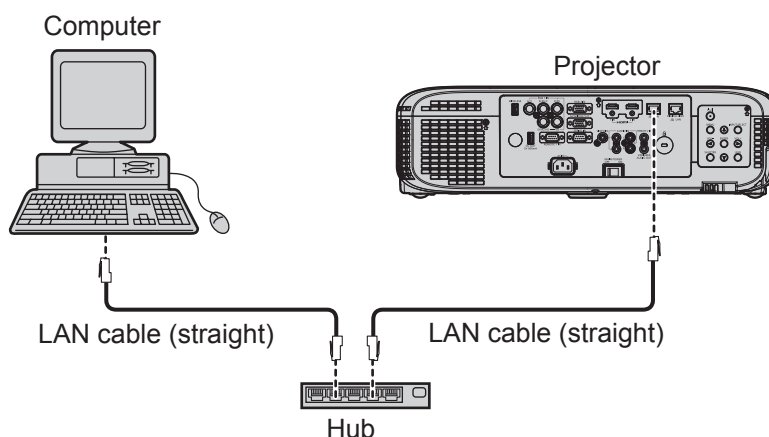

### Attention

- When a LAN cable is directly connected to the projector, the network connection must be made indoors.

**Note**

- A LAN cable is required to use the wired LAN function.
- When a LAN cable is used to transmit and receive Ethernet signal, please connect it to the <LAN> terminal or the <DIGITAL LINK/LINK> terminal of the projector.
- Use a LAN cable that is straight cable or cross cable and compatible with CAT5 or higher. When you need to know whether to use one or both straight/cross cable depending on the configuration of the system, please confirm with your network administrator. For this projector, it will identify the type of cable (straight/cross) automatically.
- Use a LAN cable with length of 100 m (328'1") or shorter.

**Example of network connections via a twisted-pair-cable transmitter**

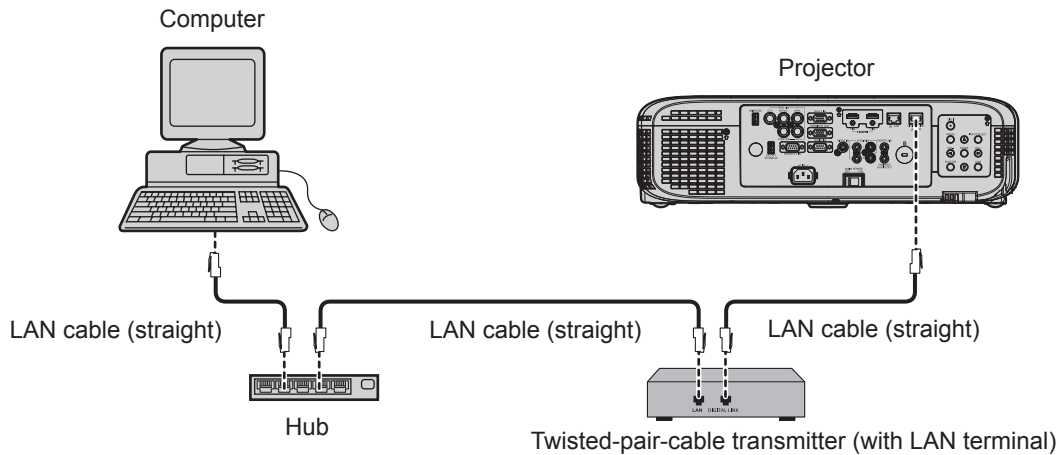

**Attention**

- When a LAN cable is directly connected to the projector, the network connection must be made indoors.

**Note**

- For the LAN cable between a twisted-pair-cable transmitter and the projector, use a cable that meets the following criteria:
  - Compatible with CAT5e or higher
  - Shielded type (including connectors)
  - Straight-through
  - Single wire
- The maximum transmission distance between the twisted-pair-cable transmitter and the projector is 100 m (328'1"). It is possible to transmit up to 150 m (492'2") if the twisted-pair-cable transmitter supports the long-reach communication method. However, the signal that the projector can receive is only up to 1080/60p (1 920 x 1 080 dots, dot clock frequency:148.5 MHz) when connected with the long-reach communication method. If this distance is exceeded, image may be disrupted or a malfunction may occur in LAN communication.
- When laying cables between a twisted-pair-cable transmitter and the projector, check that cable characteristics are compatible with CAT5e or higher using tools such as a cable tester or cable analyzer.  
When using a relay connector midway, include it in the measurement.
- Do not use a hub between a twisted-pair-cable transmitter and the projector.
- Do not pull cables forcefully. Also, do not bend or fold cables unnecessarily.
- To reduce the effects of noise as much as possible, stretch out the cables between the twisted-pair-cable transmitter and the projector without any loops.
- Lay the cables between a twisted-pair-cable transmitter and the projector away from other cables, particularly power cables.
- When installing multiple cables, run them side by side along the shortest distance possible without bundling them together.
- After laying the cables, confirm that the value of [SIGNAL QUALITY] in the [NETWORK] menu → [DIGITAL LINK STATUS] is displayed in green (indicates normal quality). (➡ page 108)
- For twisted-pair-cable transmitter of other manufacturers of which the operation has been verified with the DIGITAL LINK compatible projector, refer to Panasonic website (<https://panasonic.net/cns/projector/>). Note that the verification for devices of other manufacturers has been made for the items set by Panasonic Corporation, and not all the operations have been verified. For operation or performance problems caused by the devices of other manufacturers, contact the respective manufacturers.

**Projector settings**

- 1) Use the LAN cable (Straight) to connect the projector with computer.
- 2) Turn on the projector.
- 3) Press the <MENU> button to display the [NETWORK] menu, and then select [WIRED LAN], and press the <ENTER> button.
- 4) Set the detailed setup of [WIRED LAN].
  - For details, refer to "WIRED LAN" (➡ page 109).

**Note**

- Please confirm with your network administrator before you connect to an existing network.
- The following settings are set before the projector leaves the factory.

[DHCP]	OFF
[IP ADDRESS]	192.168.10.100
[SUBNET MASK]	255.255.255.0
[DEFAULT GATEWAY]	192.168.10.1
[DNS1]/[DNS2]	NONE

**Computer setting**

- 1) Turn on the computer.
- 2) Make the network setting according to your system administrator.
  - If the projector settings are the default settings, the computer can be used with the following network settings.

[IP ADDRESS]	192.168.10.101
[SUBNET MASK]	255.255.255.0
[DEFAULT GATEWAY]	192.168.10.1

**When connecting via wireless LAN**

The wireless module (Model No.: ET-WML100) of the optional accessories is required if you want to use the network function through the wireless LAN.

- Only one projector can be connected with the wireless LAN.

**Connection example**

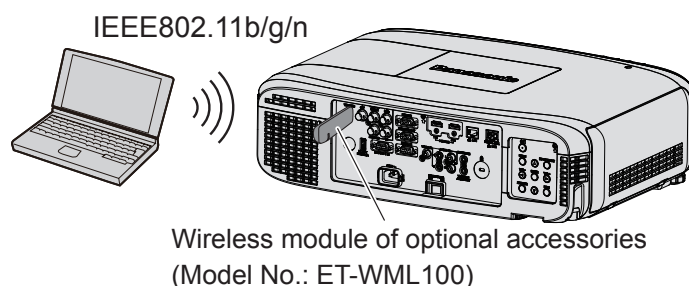

**Preparation and confirmation of the projector**

- 1) Turn on the projector.
- 2) Insert the wireless module (Model No.: ET-WML100) of optional accessories firmly into the <WIRELESS> terminal.

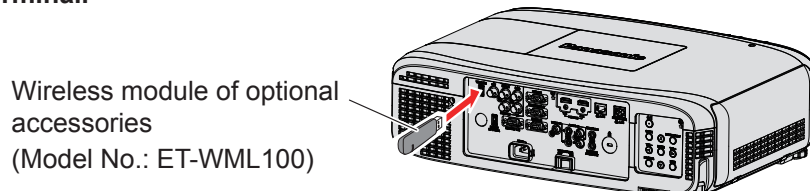

- 3) Press the <NETWORK> button to switch to NETWORK input.
  - The network input idle screen is displayed. The login password (a four-digit number that is automatically generated), PROJECTOR NAME, SSID, IP ADDRESS (WIRELESS) and IP ADDRESS (WIRED) will be displayed in the idle screen.
  - You can also press the <INPUT SELECT> button on the control panel and the input guide is displayed, then press ▲▼◀▶ to switch to NETWORK input.

Network input idle screen

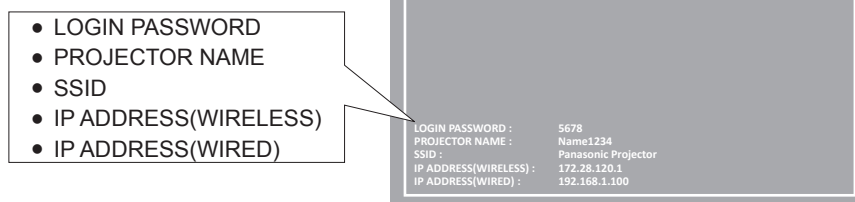

### Attention

- Please do not move or transport the projector while the wireless module is attached. Doing so may cause the wireless module to be damaged.
- The indicator of the wireless module will be off when the projector is in standby mode, it will light in blue when the power is turned on and it will blink in blue during wireless communicating.  
Please do not remove the wireless module while the indicator is blinking.
- When the power of the projector is turned on and the indicator of the wireless module is not lighting/blinking, please insert the wireless module to the <WIRELESS> terminal again.
- The [IP ADDRESS (WIRELESS)] is displayed after the power is turned on, please connect network to the projector.

### Note

- Wireless LAN and wired LAN cannot be used in the same segment.
- The settings of the wireless module are as follows. You can access the projector from the web browser to set the values of [SSID], [CHANNEL] and [ENCRYPTION].

[SSID]	NetworkDisplay
[CHANNEL]	1
[IP ADDRESS]	172.28.120.1
[SUBNET MASK]	255.255.255.0
[DEFAULT GATEWAY]	0.0.0.0
[ENCRYPTION]	Disable

### Computer setting

- 1) **Turn on the computer.**
- 2) **Make the network setting according to your system administrator.**
  - Please make the network settings for the computer and the projector according to your system administrator.
- 3) **Connect to the network that has been set in the projector.**
  - If you use a computer, click on the task tray  (bottom right of the computer), then select the same name as the [SSID] that has been set in the projector.

### Note

- If you use any wireless LAN connection utility that meets the OS standard, follow the operation instruction of the utility to connect it.

# About Presenter Light

(The wireless module (Model No.: ET-WML100) of the optional accessories is required if you want to use the network function through the wireless LAN.)

By using image transfer application software “Presenter Light” that supports Windows computers, you can transfer images and audio to the projector via the wired LAN/wireless LAN\*1.

\*1 Sound interruption or noise may occur during image / sound transfer. In such a case, please select mute in the audio setting of the application software.

## Download the “Presenter Light” to your computer

- 1) Start up the web browser on the computer.
- 2) Enter the IP address set on the projector into the URL entry field of the web browser.
- 3) Enter the user name and the password.
  - The factory default setting of the user name is user1 (user rights)/admin1 (administrator rights) and the password is panasonic (lower case).

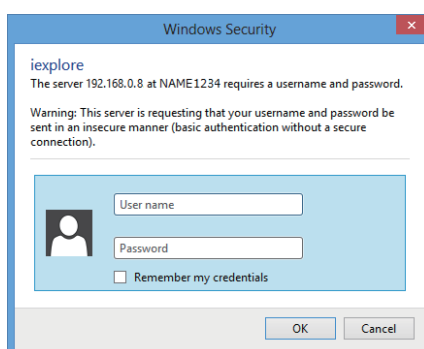

- 4) Click [OK].
  - The [Projector status] page is displayed.



- 5) Click [Download].
  - The download screen of “Presenter Light” is displayed.

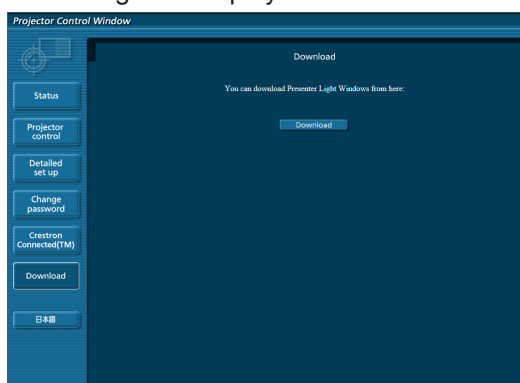

- 6) **Click [Download].**
  - The download confirmation screen of the executable file “Presenter Light.exe” is displayed.
- 7) **Save “Presenter Light.exe” on the computer desktop.**
  - This software is used as the executable file format. It cannot be installed in the computer.
  - Execute this file when using the software. Please save this software or make a shortcut for convenient use.

---

### Note

- For more details about how to use the software “Presenter Light”, please refer to the operating instructions of “Presenter Light Software” of the supplied CD-ROM.
- Download the latest versions of “Presenter Light” software from the following web site.  
URL <https://panasonic.net/cns/projector/>

## About VueMagic

---

(The wireless module (Model No.: ET-WML100) of the optional accessories is required.)

By using still image transfer application software “VueMagic”, you can transfer images to the projector when iPad/iPhone/iPod touch or Android terminals are connected to this projector through the wireless LAN.

### Connecting with the VueMagic compatible device

---

- 1) **Press the <NETWORK> button to select [NETWORK].**
  - Switch to the NETWORK input and the NETWORK input idle screen is displayed.
  - Check the login password (a four-digit number that is automatically generated), SSID and the IP address (wireless LAN) which are displayed on the NETWORK input idle screen.
  - You can also press the <INPUT SELECT> button on the control panel to select [NETWORK] in the input guide.
- 2) **Choose the SSID of this projector on the wireless LAN setting screen of the connected device, and then connect the wireless.**
- 3) **Start the VueMagic mobile presenter application of the correspondent VueMagic devices.**
- 4) **Choose the projector name of this projector in the projector list.**
  - The connection confirmation screen is displayed.
- 5) **Choose the display position.**
  - The password entry screen is displayed.
- 6) **Enter the login password and click [OK].**
  - The connected device screen is projected on the screen.

### Note

---

- When connecting to the iOS device or Android device, you must install the dedicated application “VueMagic” to the device. For detailed information, refer to the following web site. (Only in English.)  
URL <http://vuemagic.pixelworks.com>

### Disconnecting with the VueMagic compatible device

---

Close the VueMagic mobile presenter application of the device by clicking the .

# Web control function

(The wireless module (Model No.: ET-WML100) of the optional accessories is required if you want to use the network function through the wireless LAN.)

The projector has a network function, and the following operations are available from the computer by using the web control.

- Setting and adjustment of the projector
- Display of the projector status
- Transmission settings of E-mail messages

The projector supports "Crestron Connected™", and the following application software of Crestron Electronics, Inc. can be used.

- RoomView Express
- Fusion RV
- RoomView Server Edition

## Note

- If you use the E-mail function, you need to communicate with the E-mail server. First, please make sure that you can use the E-mail.
- "Crestron Connected™" is a system developed by Crestron Electronics, Inc. which collectively manage and control multiple system devices connected via the network, from a computer. This projector supports "Crestron Connected™".
- For details of "Crestron Connected™", please refer to the website of Crestron Electronics, Inc.. (Only in English)  
URL <http://www.crestron.com/>  
For the download of "RoomView Express", please refer to the website of Crestron Electronics, Inc.. (Only in English)  
URL <http://www.crestron.com/getroomview>

## Computer that can be used

In order to use the Web control function, a Web browser is required. Confirm that the Web browser can be used beforehand.

OS	Compatible web browser
Windows	Internet Explorer 9.0/10.0/11.0 Microsoft Edge
Mac OS	Safari 6.0/7.0/8.0/9.0

## Note

- Communication with an E-mail server is required to use the E-mail function. Confirm that the E-mail can be used beforehand.

## Accessing from the web browser

- 1) Start up the web browser on the computer.
- 2) Enter the IP address set on the projector into the URL entry field of the web browser.
- 3) Enter the user name and the password.
  - The factory default setting of the user name is user1 (user rights)/admin1 (administrator rights) and the password is panasonic (lower case).

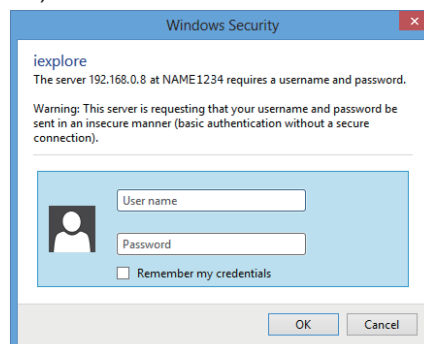

- 4) Click [OK].
  - The [Projector status] page is displayed.



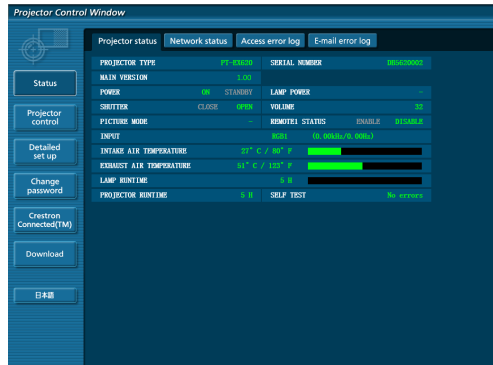

**Note**

- If you use a web browser to control the projector, set [WEB CONTROL] to [ON] in [NETWORK CONTROL] (➔ page 110).
- Do not perform setting or control simultaneously by starting up multiple web browsers. Do not set or control the projector from multiple computers.
- Change the password first. (➔ page 132)
- Access will be locked for few minutes when an incorrect password is entered three times consecutively.
- Some items on the projector setting page use the Javascript function of the web browser. The projector may not be able to be controlled properly if it is set with a browser that does not have this function enabled.
- If the screen for the web control is not displayed, consult your network administrator.
- While updating the screen for the web control, the screen may become white for a moment, but it is not a malfunction.
- About computer screen illustrations

The subsequent web control screens show examples for PT-EZ590. Screen content may differ from that for the projector model you are using. In addition, the screen size and the display may be differ from this manual depending on the OS, WEB browser or the type of computer you are using.

**Available functions per account**

With the administrator rights, all functions can be used. With the user rights, available functions are restricted. Select an account according to the purpose of use.

- ✓: The operation can be performed.
- : The operation cannot be performed.

Item	Function	Administrator rights	User rights	Page
<b>[Status]</b>	[Projector status]	✓	✓	122
	Error information page	✓	✓	122
	[Network status]	✓	✓	123
	[Access error log]	✓	—	124
	[Mail error log]	✓	—	124
<b>[Projector control]</b>	[Basic control]	✓	✓	125
	[Advanced control]	✓	✓	125
<b>[Detailed set up]</b>	[Network config]	✓	—	125
	[Ping test]	✓	—	127
	[ECO management set up]	✓	—	127
	[E-mail set up]	✓	—	128
	[Authentication set up]	✓	—	129
	[Adjust clock]	✓	—	131
<b>[Change password]</b>	User name of [Administrator]	✓	—	132
	User name of [User]	✓	—	133
	Password of [Administrator]	✓	—	132
	Password of [User]	✓	✓	133
<b>[Crestron Connected(TM)]</b>	Control page	✓	—	134
	[Tools]	✓	—	134
	[Info]	✓	—	135
	[Help]	✓	—	135
<b>[Download]</b>	Download Presenter Light	✓	✓	117

Descriptions of items

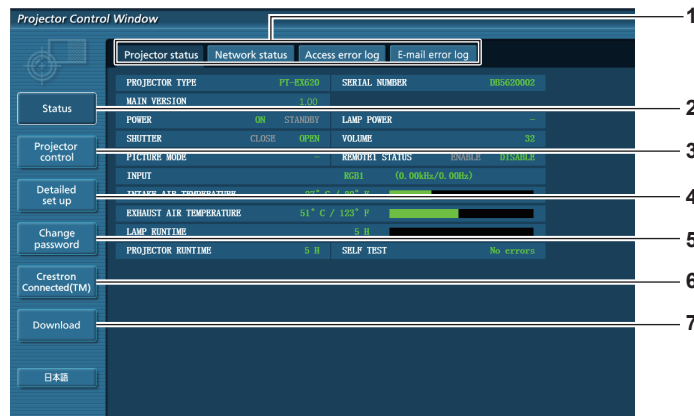

- 1 **Page tab**  
Pages are switched by clicking this item.
- 2 **[Status]**  
The status of the projector is displayed by clicking this item.
- 3 **[Projector control]**  
The [Projector control] page is displayed by clicking this item.
- 4 **[Detailed set up]**  
The [Detailed set up] page is displayed by clicking this item.
- 5 **[Change password]**  
The [Change password] page is displayed by clicking this item.
- 6 **[Crestron Connected(TM)]**  
The control page of Crestron Connected™ is displayed by clicking this item.
- 7 **[Download]**  
The download page of Presenter Light software is displayed by clicking this item. (➡ page 117)

[Projector status] page

Click [Status] → [Projector status].

Display the status of the projector for the following items.

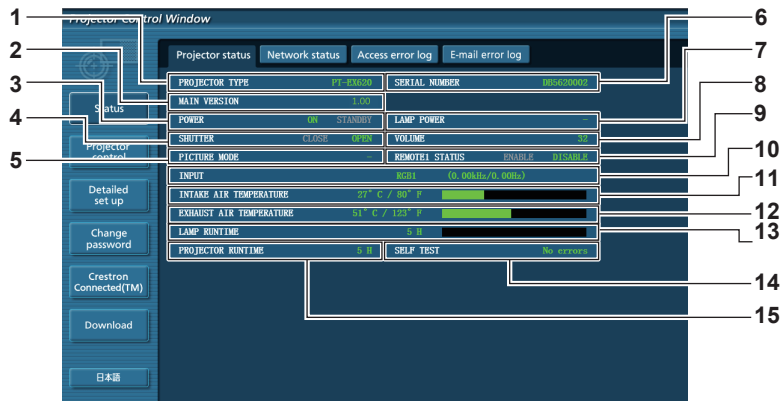

- 1 **[PROJECTOR TYPE]**  
Displays the type of the projector.
- 2 **[MAIN VERSION]**  
Displays the firmware version of the projector.
- 3 **[POWER]**  
Displays the status of the power.
- 4 **[SHUTTER]<sup>\*1</sup>**  
Displays the status of the shutter (ON: closed, OFF: open).
- 5 **[PICTURE MODE]**  
Displays the setting status of [PICTURE MODE].
- 6 **[SERIAL NUMBER]**  
Displays the serial number of the projector.
- 7 **[LAMP POWER]**  
Displays the setting status of [LAMP POWER].
- 8 **[VOLUME]**  
Displays the volume status.
- 9 **[REMOTE1 STATUS]**  
Displays the status of the contact control.
- 10 **[INPUT]**  
Displays the status of the selected input.
- 11 **[INTAKE AIR TEMPERATURE]**  
Displays the status of the air intake temperature of the projector.
- 12 **[EXHAUST AIR TEMPERATURE]**  
Displays the status of the exhaust air temperature of the projector.
- 13 **[LAMP RUNTIME]**  
Displays the runtime of the lamps (converted value).
- 14 **[SELF TEST]**  
Displays the self-diagnosis information.
- 15 **[PROJECTOR RUNTIME]**  
Displays the runtime of the projector.

\*1 [SHUTTER] is for PT-EZ590, PT-EW650 and PT-EX620.  
[AV MUTE] is for PT-EW550 and PT-EX520. Displays the status of the AV mute.

Error information page

When [Error (Detail)] or [Warning (Detail)] is displayed in the self-diagnosis display of the [Projector status] screen, click it to display the error/warning details.

- The projector may go into the standby status to protect the projector depending on the contents of the error.

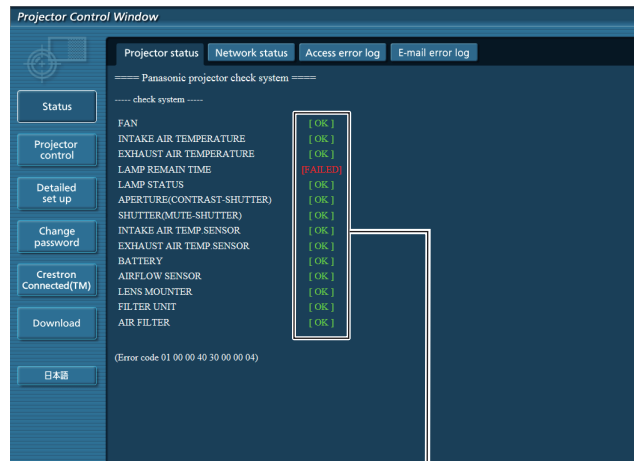
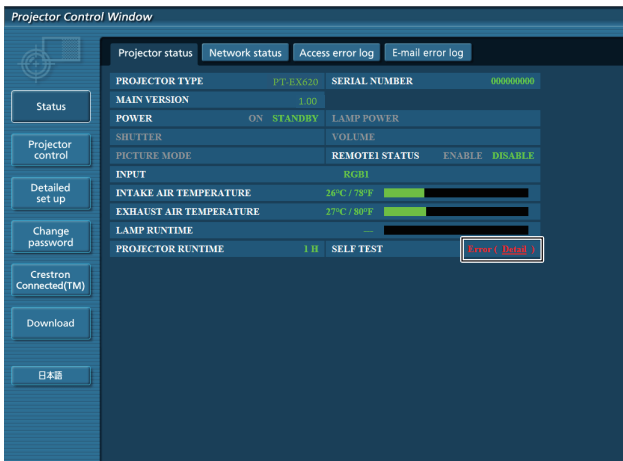

1

### 1 Self-diagnosis result display

Displays the item check results.

**[OK]**: Indicates that operation is normal.

**[FAILED]**: Indicates that there is a problem.

**[WARNING]**: Indicates that there is a warning.

### ■ [FAILED] items displayed when a problem occurs

Item	Description
[FAN]	Trouble has occurred in the fan or its drive circuit. Consult your dealer.
[FAN(R_B)]	Trouble has occurred in the R/B panel cooling fan.
[FAN(G)]	Trouble has occurred in the G panel cooling fan.
[FAN(PBS)]	Trouble has occurred in the PBS cooling fan.
[FAN(LAMP)]	Trouble has occurred in the lamp cooling fan.
[FAN(REAR)]	Trouble has occurred in the rear fan.
[FAN(POWER)]	Trouble has occurred in the power cooling fan.
[FAN(EXHAUST)]	Trouble has occurred in the exhaust fan.
[INTAKE AIR TEMPERATURE]	The air intake temperature is too high. The projector may be used in an operating environment where the temperature is high, such as near a heating appliance.
[EXHAUST AIR TEMPERATURE]	The exhaust air temperature is high. The air exhaust port may be blocked.
[LAMP REMAIN TIME]	The lamp runtime has exceeded the prescribed cumulative time, and it is now time to replace the lamp.
[LAMP STATUS]	The lamp has failed to light. Wait a short while for the lamp to cool off, and then turn on the power.
[APERTURE (CONTRAST-SHUTTER)] <sup>*1</sup>	Trouble has occurred in the contrast shutter circuitry. Consult your dealer.
[SHUTTER (MUTE-SHUTTER)] <sup>*1</sup>	Trouble has occurred in the shutter circuitry. Consult your dealer.
[INTAKE AIR TEMP.SENSOR]	Trouble has occurred in the sensor used to detect intake air temperature. Consult your dealer.
[EXHAUST AIR TEMP.SENSOR]	Trouble has occurred in the sensor used to detect exhaust air temperature. Consult your dealer.
[BATTERY]	Battery replacement is required. Consult your dealer.
[AIRFLOW SENSOR]	Trouble has occurred in the sensor used to detect airflow. Consult your dealer.
[LENS MOUNTER]	Trouble has occurred in the lens mouter. Consult your dealer.
[FILTER UNIT]	The air filter unit is not attached. Check the attachment of the air filter unit. (▶ page 140)
[AIR FILTER]	There is too much dust accumulated in the air filter unit. Turn the <MAIN POWER> switch to <OFF> (▶ page 51), and clean the air filter. (▶ page 140)

\*1 Only for PT-EZ590, PT-EW650 and PT-EX620

### [Network status] page

Click [Status] → [Network status].

The current network setting status is displayed.



**[Basic control] page**

Click [Projector control] → [Basic control].

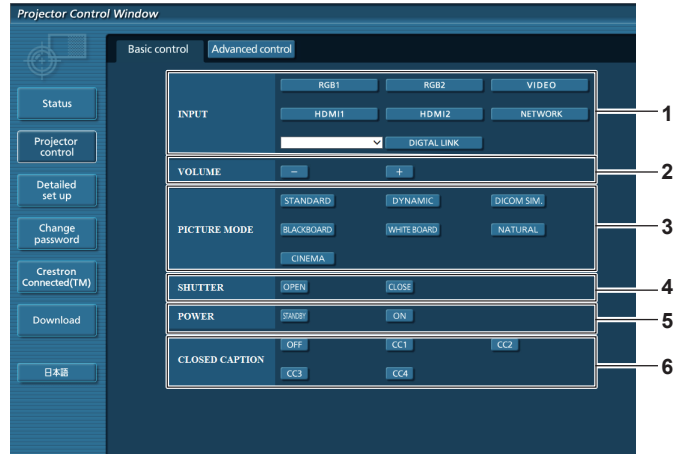

- |  |   |
|--|---|
| <p>1 <b>[INPUT]</b> *1<br/>Switches the input signal.</p> <p>2 <b>[VOLUME]</b><br/>Adjusts the volume.</p> <p>3 <b>[PICTURE MODE]</b><br/>Switches the picture mode.</p> | <p>4 <b>[SHUTTER]</b> *2<br/>Switches the setting whether to use the shutter function (closing/opening of the shutter).</p> <p>5 <b>[POWER]</b><br/>Turns on/off the power.</p> <p>6 <b>[CLOSED CAPTION]</b><br/>Switches the closed caption setting.</p> |
|--|---|

\*1 [DIGITAL LINK] is only for PT-EZ590, PT-EW650 and PT-EX620

\*2 [SHUTTER] is for PT-EZ590, PT-EW650 and PT-EX620.

[AV MUTE] is for PT-EW550 and PT-EX520, which switches the AV mute function on/off.

**[Advanced control] page**

Click [Projector control] → [Advanced control].

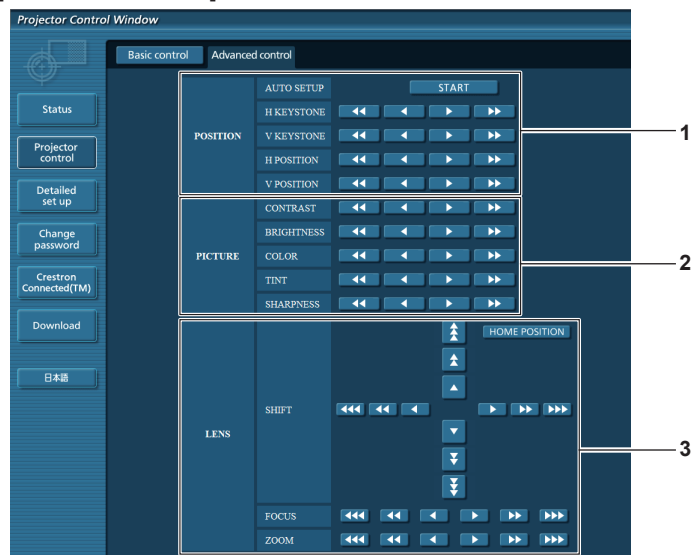

- |  |   |
|--|---|
| <p>1 <b>[POSITION]</b><br/>Operates field angle-related settings.</p> <p>2 <b>[PICTURE]</b><br/>Operates picture quality settings.</p> | <p>3 <b>[LENS]</b><br/>Adjusts the projection lens.</p> |
|--|---|

**[Network config] page**

Click [Detailed set up] → [Network config].

- 1) Click **[Network config]**.
- The **[CAUTION!]** screen is displayed.

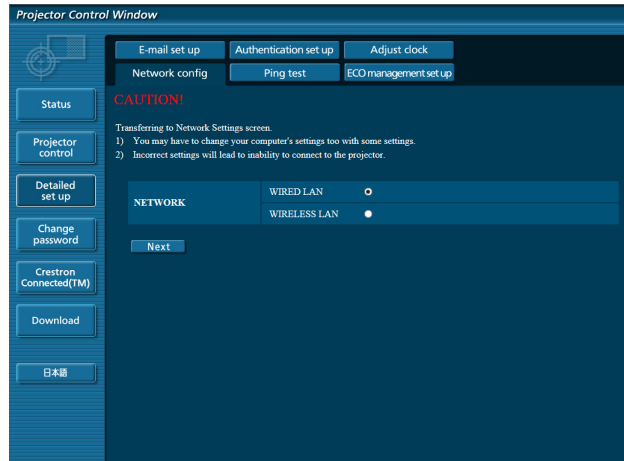

- 2) Select the item which you want to change the setting, then click [Next].
  - The current setting is displayed.
- 3) Click [Change] button.
  - The setting change screen is displayed.

### Wired LAN

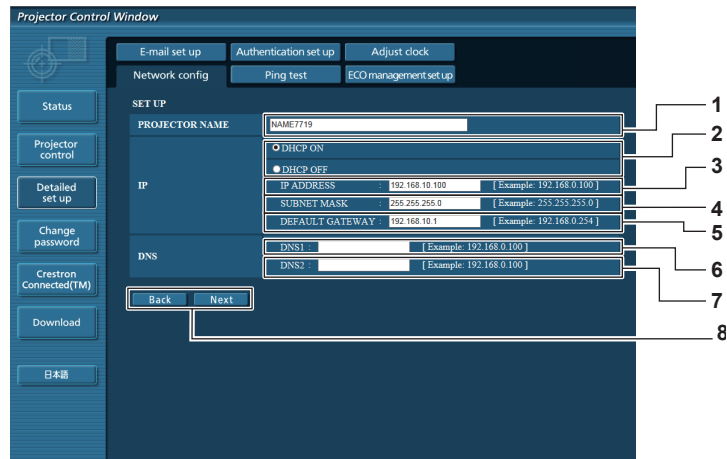

- 1 **[PROJECTOR NAME]**  
Enters the name of the projector. Enter the host name if it is required when using a DHCP server etc.
- 2 **[DHCP ON], [DHCP OFF]**  
Enables the DHCP client function, set to [DHCP ON].
- 3 **[IP ADDRESS]**  
Enters the IP address when not using a DHCP server.
- 4 **[SUBNET MASK]**  
Enters the subnet mask when not using a DHCP server.
- 5 **[DEFAULT GATEWAY]**  
Enters the default gateway address when not using a DHCP server.
- 6 **[DNS1]**  
Enters the DNS1 server address.  
Permissible characters for the entry of DNS1 server address. (preferred):  
Numbers (0 - 9), period (.)  
(Example: 192.168.0.253)
- 7 **[DNS2]**  
Enters the DNS2 server address.  
Permissible characters for the entry of DNS2 server address. (alternate):  
Numbers (0 - 9), period (.)  
(Example: 192.168.0.254)
- 8 **[Back], [Next]**  
Click the [Back] button to return to the original screen. The current settings are displayed by pressing the [Next] button. Click the [Submit] button to update the settings.

### Note

- When you use the “Forward” and “Back” functions of your browser, a warning message “Page has Expired” may appear. In that case, click [Network config] again since the following operation will not be guaranteed.
- Changing LAN settings while connected to the LAN may cause the connection to cut out.

Wireless LAN

(Only when the wireless module is attached)

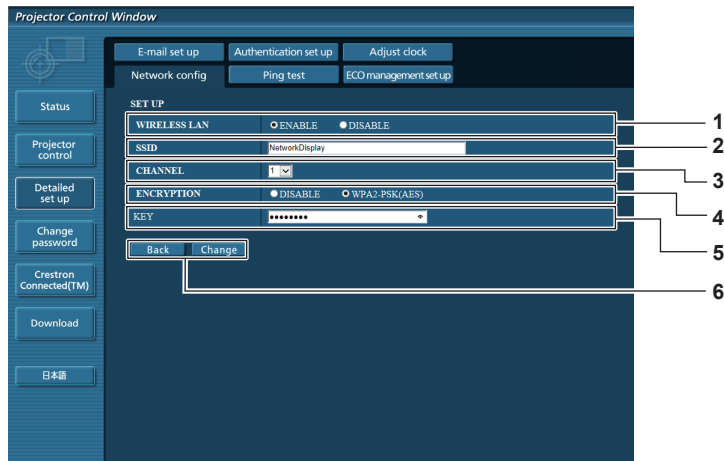

- |   |  |
|---|--|
| <p><b>1 [WIRELESS LAN]</b><br/>Selects [Enable] when you want to enable the wireless LAN function.</p> <p><b>2 [SSID]</b><br/>Sets the SSID for use.</p> <p><b>3 [CHANNEL]</b><br/>Selects the channel for use.</p> | <p><b>4 [ENCRYPTION]</b><br/>Selects [WPA2-PSK(AES)] when performing encrypted communications.</p> <p><b>5 [KEY]</b><br/>Sets the key to be used when performing encrypted communications.<br/>8 to 15 alphanumeric can be input.</p> <p><b>6 [Back], [Change]</b><br/>Click the [Back] button to return to the original screen. The setting change screen is displayed by pressing the [Change] button.<br/>Click the [Submit] button to update the settings.</p> |
|---|--|

Note

- Changing LAN settings while connected to the LAN may cause the connection to cut out.
- The setting values of the [Network config] page will return to the factory default when the [INITIALIZE] of the [NETWORK] menu is executed (→ page 111).
- The [ENCRYPTION] is set to [DISABLE] in the factory default setting. If you want to communicate with wireless LAN, it is recommended that the [ENCRYPTION] is set to [WPA2-PSK (AES)] for security.

[Ping test] page

Check whether the network is connected to the E-mail server, POP server, DNS server, etc.  
Click [Detailed set up] → [Ping test].

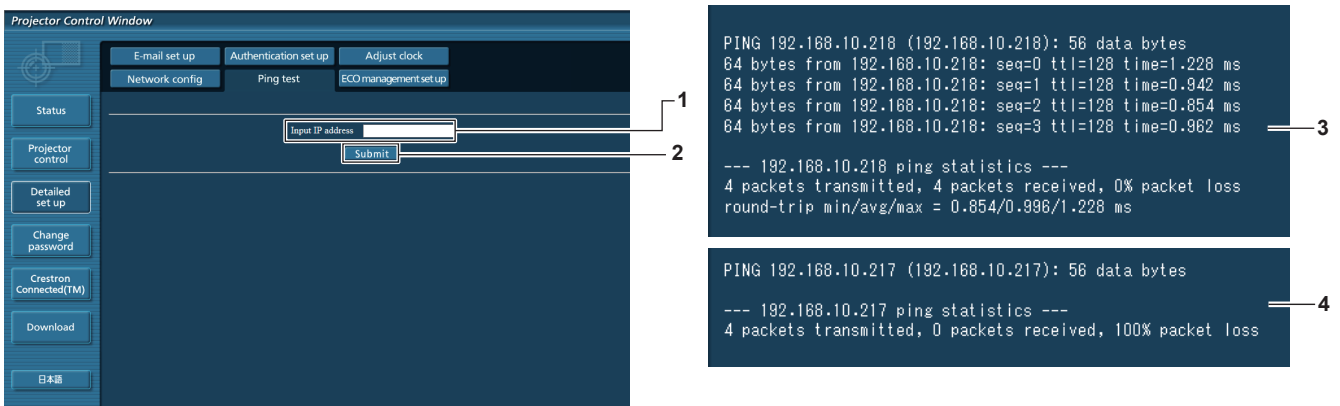

- |  |  |
|--|--|
| <p><b>1 [Input IP address]</b><br/>Enter the IP address of the server to be tested.</p> <p><b>2 [Submit]</b><br/>Executes the connection test.</p> | <p><b>3 Example of display when the connection has succeeded</b></p> <p><b>4 Example of display when the connection has failed</b></p> |
|--|--|

[ECO management set up] page

Settings related to the ECO management function of the projector can be made.  
Click [Detailed set up] → [ECO management set up].

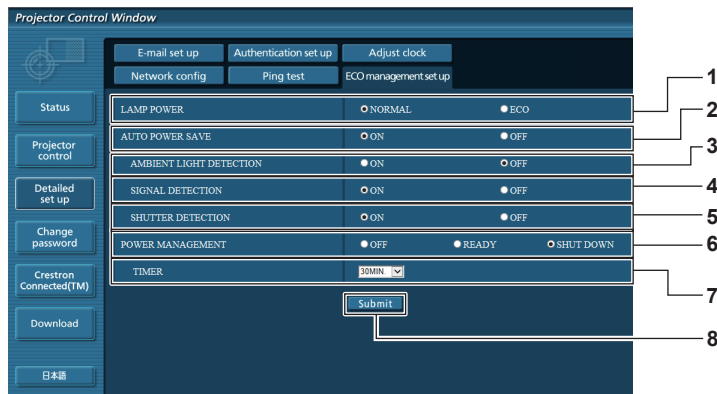

- |  |   |
|--|---|
| <p>1 <b>[LAMP POWER]</b><br/>Selects the [LAMP POWER] setting.</p> <p>2 <b>[AUTO POWER SAVE]</b><br/>Sets to [ON] when setting [AMBIENT LIGHT DETECTION], [SIGNAL DETECTION] and [SHUTTER DETECTION]*1.</p> <p>3 <b>[AMBIENT LIGHT DETECTION]</b><br/>Selects enable ([ON])/disable ([OFF]) of the environmental luminance interlock function.</p> <p>4 <b>[SIGNAL DETECTION]</b><br/>Selects enable ([ON])/disable ([OFF]) of the no signal interlock function.</p> | <p>5 <b>[SHUTTER DETECTION]</b>*1<br/>Selects to enable ([ON])/disable ([OFF]) of the shutter interlock function.</p> <p>6 <b>[POWER MANAGEMENT]</b><br/>Selects the power consumption mode.</p> <p>7 <b>[TIMER]</b><br/>Selects the time that the lamp is turned off when the POWER MANAGEMENT function is using.</p> <p>8 <b>[Submit]</b><br/>Updates the settings.</p> |
|--|---|

\*1 [SHUTTER DETECTION] is for PT-EZ590, PT-EW650 and PT-EX620  
[AV MUTE DETECTION] is for PT-EW550 and PT-EX520, it selects to enable ([ON])/disable ([OFF]) of the AV mute detection function.

**Note**

- For details of each setting item, refer to the [PROJECTOR SETUP] menu → [ECO MANAGEMENT] (➔ page 94) on the projector.

**[E-mail set up] page**

When there is a problem or the runtime of a lamp reaches a set value, an E-mail can be sent to preset E-mail addresses (up to two addresses).

Click [Detailed set up] → [E-mail set up].

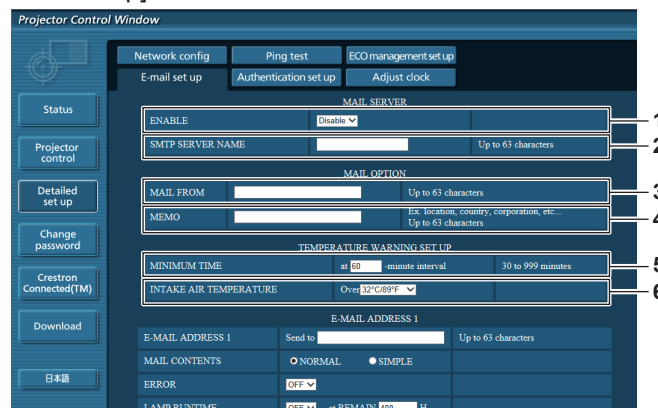

- |   |   |
|---|---|
| <p>1 <b>[ENABLE]</b><br/>Select [Enable] to use the E-mail function.</p> <p>2 <b>[SMTP SERVER NAME]</b><br/>Enter the IP address or the server name of the E-mail server (SMTP). To enter the server name, the DNS server needs to be set up.</p> <p>3 <b>[MAIL FROM]</b><br/>Enter the E-mail address of the projector. (Up to 63 characters in single byte)</p> <p>4 <b>[MEMO]</b><br/>Enter information such as the location of the projector that notifies the sender of the E-mail. (Up to 63 characters in single byte)</p> | <p>5 <b>[MINIMUM TIME]</b><br/>Change the minimum interval for the temperature warning E-mail. The default value is 60 minutes. In this case, another E-mail will not be sent for 60 minutes after sending the temperature warning E-mail even if it reaches the warning temperature.</p> <p>6 <b>[INTAKE AIR TEMPERATURE]</b><br/>Change the temperature setting for the temperature warning mail. A temperature warning E-mail is sent when the temperature exceeds this value.</p> |
|---|---|



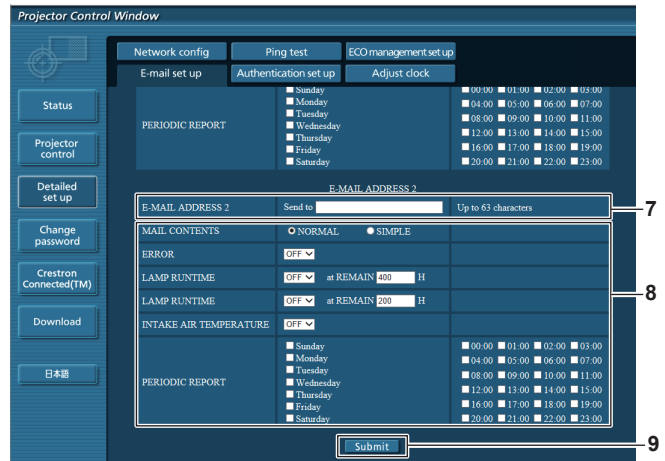
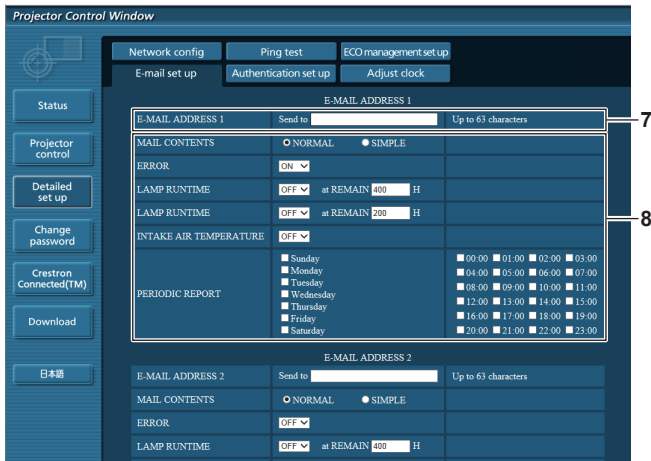

- 7 **[E-MAIL ADDRESS 1], [E-MAIL ADDRESS 2]**  
Enter the E-mail address to be sent. Leave [E-MAIL ADDRESS 2] blank when two E-mail addresses are not to be used.
- 8 **Settings of the conditions to send E-mail**  
Selects the conditions to send E-mail.  
**[MAIL CONTENTS]:**  
Selects either [NORMAL] or [SIMPLE].  
**[ERROR]:**  
Sends an E-mail when an error occurred in the self-diagnosis.  
**[LAMP RUNTIME]:**  
Sends an E-mail when the remaining time for the lamp has reached the value set at the right field.

- [INTAKE AIR TEMPERATURE]:**  
Sends an E-mail when the air intake temperature has reached the value set at the above field.  
**[PERIODIC REPORT]:**  
Places a check mark on this to send an E-mail periodically. It will be sent on the days and the time with the check mark.
- 9 **[Submit]**  
Updates the settings.

## [Authentication set up] page

Set the authentication items when POP authentication or SMTP authentication is necessary to send an E-mail. Click [Detailed set up] → [Authentication set up].

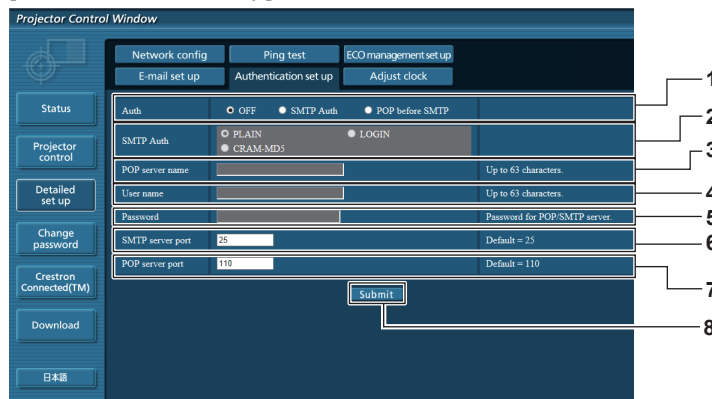

- 1 **[Auth]**  
Selects the authentication method specified by your Internet service provider.
- 2 **[SMTP Auth]**  
Set when the SMTP authentication is selected.
- 3 **[POP server name]**  
Enter the POP server name.  
Allowed characters:  
Alphanumerics (A - Z, a - z, 0 - 9)  
Minus sign (-) and period (.)
- 4 **[User name]**  
Enter the user name for the POP server or the SMTP server.

- 5 **[Password]**  
Enter the password for the POP server or the SMTP server.
- 6 **[SMTP server port]**  
Enter the port number of the SMTP server. (Normally 25)
- 7 **[POP server port]**  
Enter the port number of the POP server. (Normally 110)
- 8 **[Submit]**  
Updates the settings.

## Contents of E-mail sent

### Example of E-mail sent when E-mail is set

The following E-mail is sent when the E-mail settings have been established.

```

=== Panasonic projector report(CONFIGURE) ===
Projector Type      : PT-EZ590
Serial No          : SH1234567
----- E-mail setup data -----
TEMPERATURE WARNING SETUP
MINIMUM TIME       at [ 60] minutes interval
INTAKE AIR TEMPERATURE Over [ 45 degC / 113 degF ]

ERROR              [ OFF ]
LAMP RUNTIME       [ OFF ] at REMAIN [ 400] H
LAMP RUNTIME       [ OFF ] at REMAIN [ 200] H
INTAKE AIR TEMPERATURE [ OFF ]

PERIODIC REPORT
Sunday [ OFF ] Monday [ OFF ] Tuesday [ OFF ] Wednesday [ OFF ]
Thursday [ OFF ] Friday [ OFF ] Saturday [ OFF ]
00:00 [ OFF ] 01:00 [ OFF ] 02:00 [ OFF ] 03:00 [ OFF ]
04:00 [ OFF ] 05:00 [ OFF ] 06:00 [ OFF ] 07:00 [ OFF ]
08:00 [ OFF ] 09:00 [ OFF ] 10:00 [ OFF ] 11:00 [ OFF ]
12:00 [ OFF ] 13:00 [ OFF ] 14:00 [ OFF ] 15:00 [ OFF ]
16:00 [ OFF ] 17:00 [ OFF ] 18:00 [ OFF ] 19:00 [ OFF ]
20:00 [ OFF ] 21:00 [ OFF ] 22:00 [ OFF ] 23:00 [ OFF ]

----- check system -----
FAN                  [ OK ]
INTAKE AIR TEMPERATURE [ OK ]
EXHAUST AIR TEMPERATURE [ OK ]
LAMP REMAIN TIME     [ OK ]
LAMP STATUS          [ OK ]
APERTURE (CONTRAST-SHUTTER)*1 [ OK ]
SHUTTER (MUTE-SHUTTER)*1 [ OK ]
INTAKE AIR TEMP.SENSOR [ OK ]
EXHAUST AIR TEMP.SENSOR [ OK ]
BATTERY              [ OK ]
AIRFLOW SENSOR       [ OK ]
LENS MOUNTER         [ OK ]
FILTER UNIT          [ OK ]
AIR FILTER           [ OK ]

(Error code 00 00 00 00 00 00 00 00)

Intake air temperature : 31 degC / 87 degF
Exhaust air temperature : 37 degC / 98 degF

PROJECTOR RUNTIME      600 H

LAMP ECO               500 H
LAMP NORMAL            100 H
LAMP REMAIN            3500 H

----- Current status -----
MAIN VERSION          1.00
SUB VERSION           1.00
LAMP STATUS           LAMP=ON

INPUT                 HDMI1
SIGNAL NAME           XGA60
SIGNAL FREQUENCY      0.00kHz / 0.00Hz
REMOTE1 STATUS        DISABLE

----- Wired Network configuration -----
DHCP Client           OFF
IP address            192.168.10.100
MAC address           04:20:9A:00:00:00

----- Wireless Network configuration -----
DHCP Client           OFF
IP address            172.28.120.1
MAC address           00:40:63:00:00:00

Tue Apr 12 10:00:00 2016

----- Memo -----

```

\*1 Only for PT-EZ590, PT-EW650 and PT-EX620

### Example of the E-mail sent for an error

The following E-mail is sent when an error has occurred.

```

=== Panasonic projector report(ERROR) ===
Projector Type      : PT-EZ590
Serial No         : SH1234567
----- check system -----
FAN                [ OK ]
INTAKE AIR TEMPERATURE [ OK ]
EXHAUST AIR TEMPERATURE [ OK ]
LAMP REMAIN TIME   [ OK ]
LAMP STATUS        [ OK ]
APERTURE (CONTRAST-SHUTTER) *1 [ OK ]
SHUTTER (MUTE-SHUTTER) *1 [ OK ]
INTAKE AIR TEMP.SENSOR [ OK ]
EXHAUST AIR TEMP.SENSOR [ OK ]
BATTERY            [ OK ]
AIRFLOW SENSOR     [ OK ]
LENS MOUNTER       [ OK ]
FILTER UNIT        [ OK ]
AIR FILTER         [ FAILED ]

(Error code 00 00 00 20 00 00 00 00)

Intake air temperature : 31 degC / 87 degF
Exhaust air temperature : 37 degC / 98 degF

PROJECTOR RUNTIME      600 H

LAMP ECO               500 H
LAMP NORMAL            100 H
LAMP REMAIN            3500 H

----- Current status -----
MAIN VERSION          1.00
SUB VERSION           1.00
LAMP STATUS           LAMP=OFF

INPUT                 HDMI1

----- Wired Network configuration -----
DHCP Client          OFF
IP address            192.168.10.100
MAC address           04:20:9A:00:00:00

----- Wireless Network configuration -----
DHCP Client          OFF
IP address            172.28.120.1
MAC address           00:40:63:00:00:00

Tue Apr 12 10:00:00 2016

----- Memo -----

```

\*1 Only for PT-EZ590, PT-EW650 and PT-EX620

## [Adjust clock] page

Click [Detailed set up] → [Adjust clock].

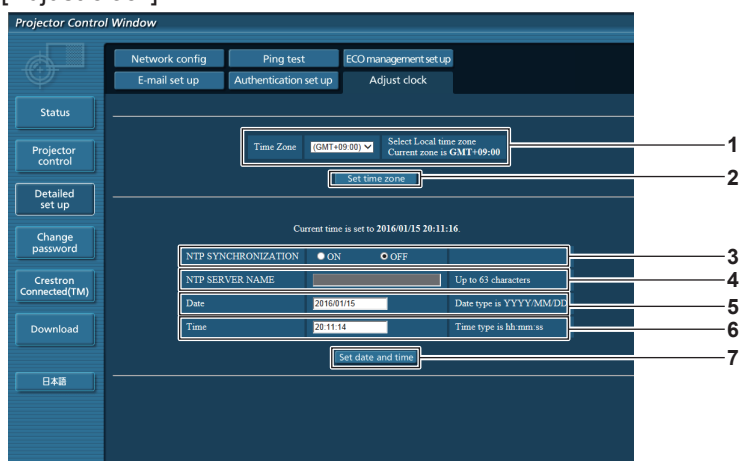

- |   |   |
|---|---|
| <p><b>1 [Time Zone]</b><br/>Selects the time zone.</p> <p><b>2 [Set time zone]</b><br/>Updates the time zone setting.</p> <p><b>3 [NTP SYNCHRONIZATION]</b><br/>Sets to [ON] to adjust the date and the time automatically.</p> <p><b>4 [NTP SERVER NAME]</b><br/>Enter the IP address or server name of the NTP server when you set to adjust the date and the time manually.<br/>(To enter the server name, the DNS server needs to be set up.)</p> | <p><b>5 [Date]</b><br/>Enter the date to be changed.</p> <p><b>6 [Time]</b><br/>Enter the time to be changed.</p> <p><b>7 [Set date and time]</b><br/>Updates the date and the time settings.</p> |
|---|---|

**Note**

- The replacement of the battery inside the projector is required when the time goes out of alignment right after correcting the time. Consult your dealer.

**[Change password] page**

Click [Change password].

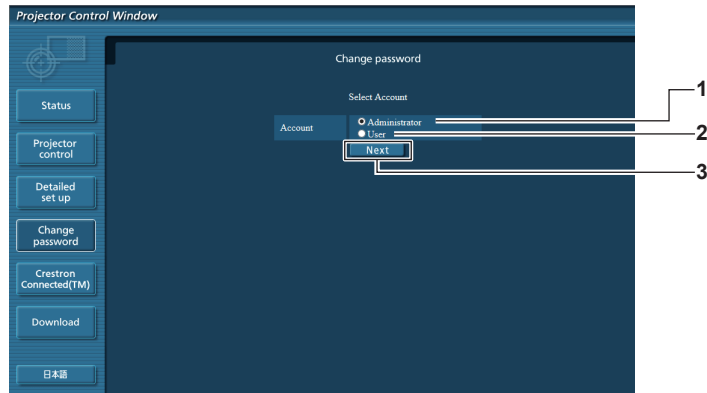

- |   |  |
|---|--|
| <p>1 <b>[Administrator]</b><br/>Used to change the setting of the [Administrator].</p> <p>2 <b>[User]</b><br/>Used to change the setting of the [User].</p> | <p>3 <b>[Next]</b><br/>Used to display the screen for changing the password.</p> |
|---|--|

**[Administrator] account**

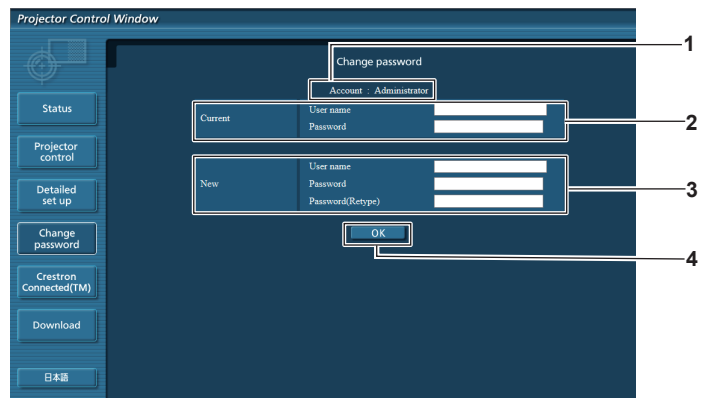

- |   |  |
|---|--|
| <p>1 <b>[Account]</b><br/>Displays the account to change.</p> <p>2 <b>[Current]</b><br/><b>[User name]:</b><br/>Enter the user name before the change.<br/><b>[Password]:</b><br/>Enter the current password.</p> | <p>3 <b>[New]</b><br/><b>[User name]:</b><br/>Enter the desired new user name. (Up to 16 characters in single byte)<br/><b>[Password]:</b><br/>Enter the desired new password. (Up to 16 characters in single byte)<br/><b>[Password(Retype)]:</b><br/>Enter the desired new password again.</p> <p>4 <b>[OK]</b><br/>Determines the change of password.</p> |
|---|--|

**[User] account**

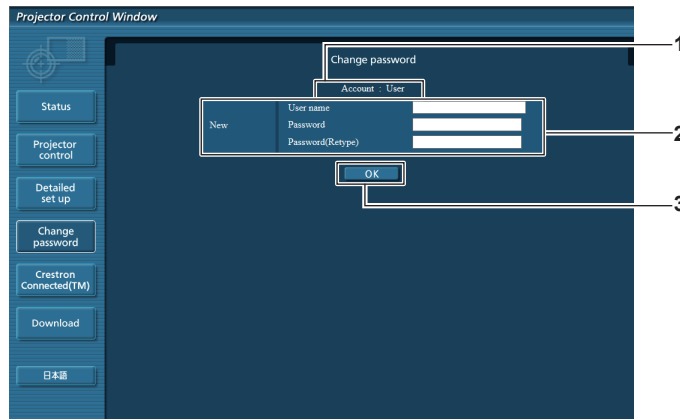

- |  |   |
|--|---|
| <p><b>1 [Account]</b><br/>Displays the account to change.</p> <p><b>2 [New]</b><br/><b>[User name]:</b><br/>Enter the desired new user name. (Up to 16 characters in single byte)<br/><b>[Password]:</b><br/>Enter the desired new password. (Up to 16 characters in single byte)<br/><b>[Password(Retype)]:</b><br/>Enter the desired new password again.</p> | <p><b>3 [OK]</b><br/>Determines the change of password.</p> |
|--|---|

**[Change password] (For user rights)**

The change of password is enabled only under the user rights.

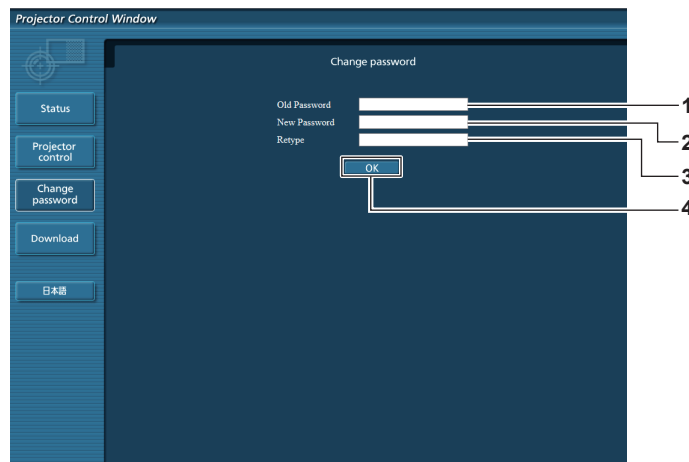

- |  |  |
|--|--|
| <p><b>1 [Old Password]</b><br/>Enter the current password.</p> <p><b>2 [New Password]</b><br/>Enter the desired new password. (Up to 16 characters in single byte)</p> | <p><b>3 [Retype]</b><br/>Enter the desired new password again.</p> <p><b>4 [OK]</b><br/>Determines the change of password.</p> |
|--|--|

**Note**

- To change the account of the administrator, you must enter the [User name] and the [Password] in [Current].

**[Crestron Connected(TM)] page**

The projector can be monitored/controlled with Crestron Connected™.

To start the control page of Crestron Connected™ from the web control screen, you need to access with the administrator rights. (For user rights, the [Crestron Connected(TM)] button is not displayed on the web control screen.)

The control page of Crestron Connected™ is displayed by clicking [Crestron Connected(TM)].

It is not displayed if Adobe® Flash® Player is not installed on the computer used, or the browser used does not support Flash. In that case, click [Back] on the control page to go back to the previous page.

Control page

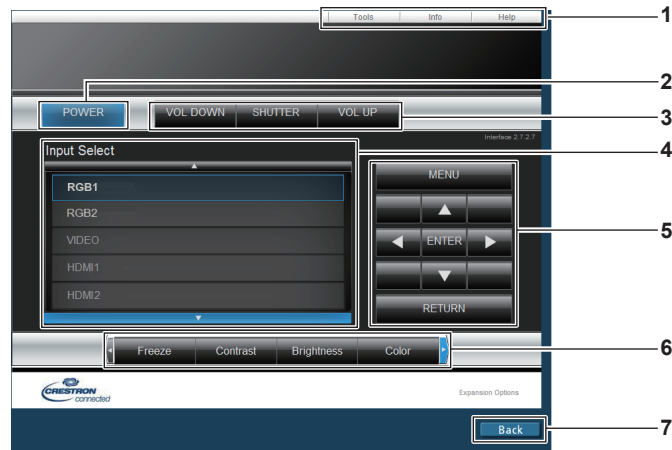

- |   |   |
|---|---|
| <p>1 <b>[Tools], [Info], [Help]</b><br/>Tabs for selecting the setting, information, or help page of the projector.</p> <p>2 <b>[POWER]</b><br/>Turns off/on the power.</p> <p>3 <b>[VOL DOWN], [VOL UP]</b><br/>Adjusts the volume.<br/><b>[SHUTTER]</b><sup>*1</sup><br/>Switches the setting whether to use the shutter function (closing/opening of the shutter).</p> | <p>4 <b>[Input Select]</b><br/>Controls input selection.<br/>Not available when the power of the projector is turned off.</p> <p>5 <b>Menu screen control buttons</b><br/>Navigates the menu screen.</p> <p>6 <b>Freeze/image quality adjustment/digital zoom</b><br/>Controls items related to freeze/image quality/digital zoom.</p> <p>7 <b>[Back]</b><br/>Performs return to the previous page.</p> |
|---|---|
- \*1 [SHUTTER] is for PT-EZ590, PT-EW650 and PT-EX620.  
[AV MUTE] is for PT-EW550 and PT-EX520, which switches the AV mute function on/off.

[Tools] page

Click [Tools] on the control page.

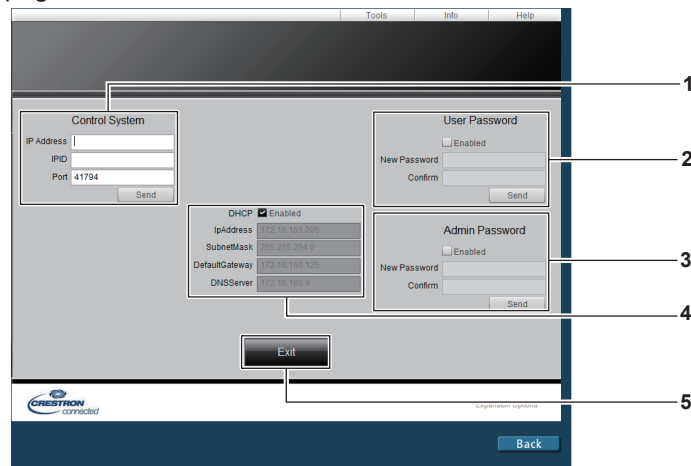

- |  |  |
|--|--|
| <p>1 <b>[Control System]</b><br/>Sets the information required for communicating with the controller to be connected with the projector.</p> <p>2 <b>[User Password]</b><br/>Sets the user rights password for the Crestron Connected™ control page.</p> <p>3 <b>[Admin Password]</b><br/>Sets the administrator rights password for the Crestron Connected™ control page.</p> | <p>4 <b>Network status</b><br/>Displays the settings of wired LAN.<br/><b>[DHCP]</b><br/>Displays the current setting.<br/><b>[IpAddress]</b><br/>Displays the current setting.<br/><b>[SubnetMask]</b><br/>Displays the current setting.<br/><b>[DefaultGateway]</b><br/>Displays the current setting.<br/><b>[DNSServer]</b><br/>Displays the current setting.</p> <p>5 <b>[Exit]</b><br/>Returns to the control page.</p> |
|--|--|

**[Info] page**

Click [Info] on the control page.

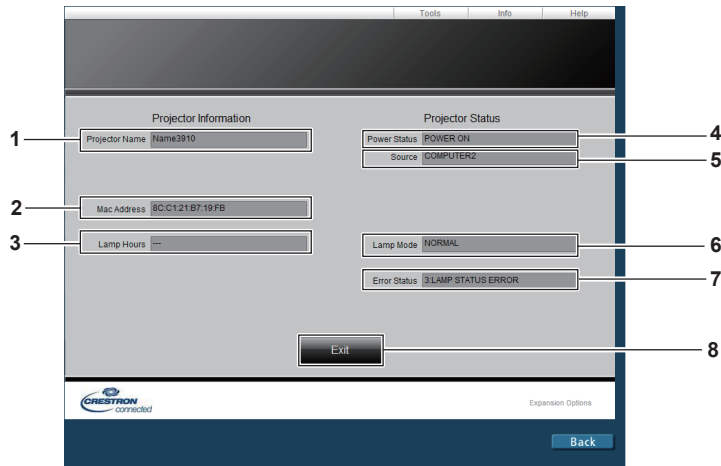

- |  |  |
|--|--|
| <p><b>1 [Projector Name]</b><br/>Displays the projector name.</p> <p><b>2 [Mac Address]</b><br/>Displays the MAC address.</p> <p><b>3 [Lamp Hours]</b><br/>Displays the runtime of the lamps (converted value).</p> <p><b>4 [Power Status]</b><br/>Displays the status of the power.</p> | <p><b>5 [Source]</b><br/>Displays the selected input.</p> <p><b>6 [Lamp Mode]</b><br/>Displays the setting status of [LAMP POWER].</p> <p><b>7 [Error Status]</b><br/>Displays the error status.</p> <p><b>8 [Exit]</b><br/>Returns to the control page.</p> |
|--|--|

**[Help] page**

Click [Help] on the control page.

The [Help Desk] window is displayed.

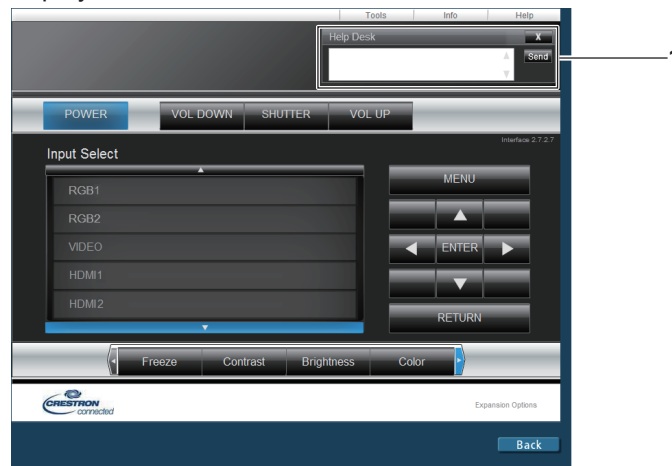

- 1 [Help Desk]**  
Send/receive messages to/from an administrator who uses Crestron Connected™.

# Chapter 6 Maintenance

---

This chapter describes methods of inspection when there are problems, maintenance, and replacement of the units.



# Lamp/temperature/filter indicators

## When an indicator lights up

If a problem should occur inside the projector, the lamp indicator <LAMP>, the temperature indicator <TEMP>, and the filter indicator <FILTER> will inform you by lighting or blinking. Check the status of the indicators and remedy the indicated problems as follows.

### Attention

- When switching off the projector to deal with problems, make sure to follow the procedure in "Switching off the projector" (➔ page 51).

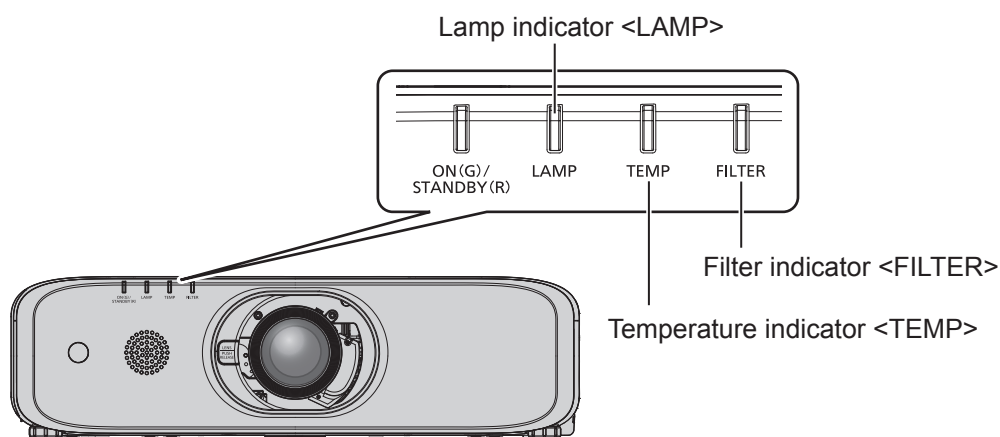

## Lamp indicator <LAMP>

Indicator status	Lighting in red	Blinking in red (1 time)	Blinking in red (3 times)	
<b>Status</b>	Time to replace the lamp unit. (➔ page 142)	The lamp unit is not installed.	A problem is detected in the lamp or the power supply for the lamp.	
<b>Cause</b>	<ul style="list-style-type: none"> <li>Was [REPLACE LAMP] displayed when you turned on the power?</li> <li>The indicator lights up when the runtime of the lamp unit reaches 3 800 hours (when [LAMP POWER] is set to [NORMAL]).</li> </ul>	<ul style="list-style-type: none"> <li>Is the lamp unit installed?</li> </ul>	<ul style="list-style-type: none"> <li>Have you turned on the power again immediately after turning it off?</li> </ul>	<ul style="list-style-type: none"> <li>Some error has occurred in the lamp circuit. Check for fluctuation (or drop) in the source voltage.</li> </ul>
<b>Solution</b>	<ul style="list-style-type: none"> <li>Replace the lamp unit.</li> </ul>	<ul style="list-style-type: none"> <li>Install the lamp unit if it is not installed.</li> <li>If the indicator is still blinking in red even when having installed the lamp unit, consult your dealer.</li> </ul>	<ul style="list-style-type: none"> <li>Wait a while until the luminous lamp cools off, and then turn on the power.</li> </ul>	<ul style="list-style-type: none"> <li>Turn the &lt;MAIN POWER&gt; switch to &lt;OFF&gt; (➔ page 51), and consult your dealer.</li> </ul>

### Note

- If the lamp indicator <LAMP> is still lit or blinking after taking the preceding measures, ask your dealer for repair.
- The lamp indicator <LAMP> lights in green while the projector is in projection mode if there is no notification by lighting or blinking in red.

### Temperature indicator <TEMP>

Indicator status	Lighting in red	Blinking in red (2 times)	Blinking in red (3 times)
<b>Status</b>	Internal temperature is high (warning).	Internal temperature is high (standby status).	The cooling fan has stopped.
<b>Cause</b>	<ul style="list-style-type: none"> <li>Is the air intake/exhaust port blocked?</li> <li>Is the room temperature high?</li> <li>Is the filter indicator &lt;FILTER&gt; lit?</li> </ul>		—
<b>Solution</b>	<ul style="list-style-type: none"> <li>Remove any objects that are blocking the air intake/exhaust port.</li> <li>Install the projector in a location with the operating environment temperature between 0 °C (32 °F) and 45 °C (113 °F)*1.</li> <li>Do not install the projector at high altitudes of 2 700 m (8 858') or higher above sea level.</li> <li>Clean or replace the air filter unit. (➡ page 139)</li> </ul>		<ul style="list-style-type: none"> <li>Turn the &lt;MAIN POWER&gt; switch to &lt;OFF&gt; (➡ page 51), and consult your dealer.</li> </ul>

\*1 When using the projector at high altitudes (between 1 400 m (4 593') and 2 700 m (8 858') above sea level), the operating environment temperature should be between 0 °C (32 °F) and 40 °C (104 °F).

#### Note

- If the temperature indicator <TEMP> is still lit or blinking after taking the preceding measures, ask your dealer for repair.
- If the [PROJECTOR SETUP] menu → [LAMP POWER] is set to [NORMAL], [LAMP POWER] changes to [ECO] forcibly to protect the projector when the operating environment temperature becomes 40 °C (104 °F) or higher (35 °C (95 °F) or higher when using the projector at high altitudes).

### Filter indicator <FILTER>

Indicator status	Lighting in red		Blinking in red
<b>Status</b>	The filter is clogged. The temperature inside or outside the projector is abnormally high.		The air filter unit is not attached.
<b>Cause</b>	<ul style="list-style-type: none"> <li>Is the air filter unit dirty?</li> </ul>	<ul style="list-style-type: none"> <li>Is the air intake/exhaust port blocked?</li> </ul>	<ul style="list-style-type: none"> <li>Is the air filter unit attached?</li> </ul>
<b>Solution</b>	<ul style="list-style-type: none"> <li>Clean or replace the air filter unit. (➡ page 139)</li> </ul>	<ul style="list-style-type: none"> <li>Remove any objects that are blocking the air intake/exhaust port.</li> </ul>	<ul style="list-style-type: none"> <li>Attach the air filter unit.</li> </ul>

#### Note

- If the filter indicator <FILTER> is still lit or blinking after taking the preceding measures, ask your dealer for repair.
- If the air filter case is not attached when the projector is switched on, the filter indicator <FILTER> blinks in red.

# Maintenance/replacement

## Before performing maintenance/replacement

- Make sure to turn off the power before maintaining the projector or replacing the unit. (➔ page 51)
- When switching off the projector, make sure to follow the procedures in “Switching off the projector” (➔ page 51).

## Maintenance

### Outer case

Wipe off dirt and dust with a soft, dry cloth.

- If the dirt is persistent, soak the cloth with water and wring it thoroughly before wiping. Dry off the projector with a dry cloth.
- Do not use benzene, thinner, or rubbing alcohol, other solvents, or household cleaners. Doing so may deteriorate the outer case.
- When using chemically treated dust cloths, follow the instructions written on its packaging.

### Lens front surface

Wipe off dirt and dust from the front surface of the lens with a soft clean cloth.

- Do not use a cloth that is fluffy, dusty, or soaked with oil/water.
- Since the lens is fragile, do not use excessive force when wiping the lens.
- Do not use benzene, thinner or rubbing alcohol, other solvents or household cleaners. Using them may cause deterioration of the lens.

### Attention

- The lens is made of glass. Impacts or excessive force when wiping may scratch its surface. Handle with care.

### Air filter unit

Perform maintenance of the air filter in the following case.

- The air filter is clogged with dust, causing the filter replacement message to appear on the screen and the filter indicator <FILTER> to light in red.

### Attention

- Make sure that the projector is stable, and perform the maintenance in a safe place where the unit will not be damaged even if you drop the air filter cover and the air filter unit.
- After replacing the air filter, reset the filter counter. Otherwise, “FILTER COUNTER has reached the set time.” will appear on screen.

### Removing the air filter unit

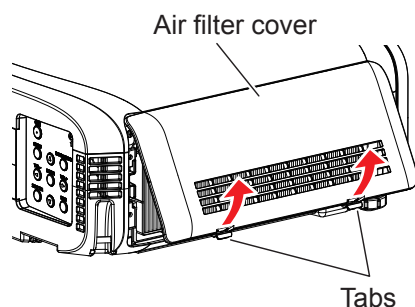

Fig. 1

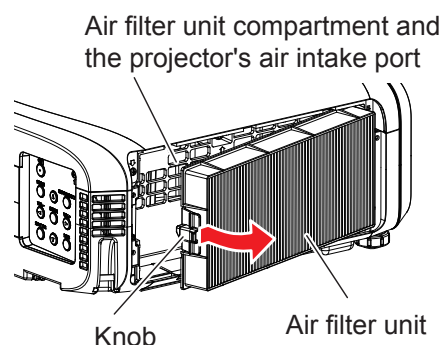

Fig. 2

- 1) Turn off the power of the projector and set the <MAIN POWER> switch to <OFF> and disconnect the power plug from the power outlet.
- 2) Remove the air filter cover (Fig. 1).

- Pull out the air filter cover from the hook of the projector while slightly pushing upward the tabs of the air filter cover and open it in the direction of the arrow in figure.
- When pulling open the air filter cover, be sure to firmly hold the air filter cover with your hand. Opening the air filter cover quickly may result in the cover falling.
- Vacuum dust from the air filter with a vacuum cleaner.

### 3) Remove the air filter unit.

- Pull out the air filter unit from the tabs of the projector while slightly pressing the knob at the center of the frame at the connecting terminal side (rear side) inward as shown by the arrow, and remove the air filter unit. (Fig. 2)
- After pulling out the air filter unit, remove foreign objects and dust from the air filter unit compartment and the projector's air intake port if there are any.

---

### Cleaning the air filter unit

---

Remove the air filter unit beforehand according to the previously described procedure in “Removing the air filter unit”.

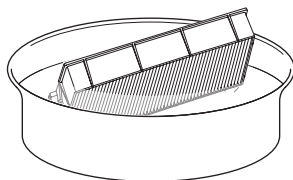

Fig. 1

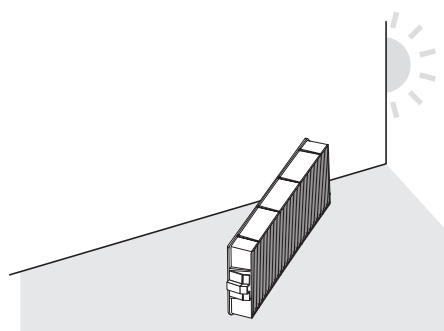

Fig. 2

#### 1) Wash the air filter unit. (Fig. 1)

- i) Soak the air filter unit in cold or warm water and then lightly rinse it.
  - Do not use cleaning tools such as brushes.
  - When rinsing, hold the frame of the air filter unit without putting strong pressure on the filter.
- ii) Rinse the air filter unit two or three times by using fresh water each time.
  - Insufficient rinsing may result in odors.

#### 2) Dry the air filter unit. (Fig. 2)

- Let the air filter unit naturally dry off in a well-ventilated place where there is little dust and is not exposed to direct sunlight.
- Do not dry using drying devices such as dryers.
- After the air filter unit is dried, proceed to “Attaching the air filter unit” (➔ page 140).

---

### Attaching the air filter unit

---

#### 1) Attach the air filter unit to the projector.

- Perform Step 3) in “Removing the air filter unit” in the reverse order.
- Push in the air filter unit securely until it clicks into place.

#### 2) Attach the air filter cover to the projector.

- Perform Step 2) in “Removing the air filter unit” in the reverse order to close the air filter cover, and push in the air filter cover securely until it clicks into place.
- Make sure that the air filter cover is closed tightly.

---

### Procedure of [FILTER COUNTER RESET]

---

- 1) Connect the power plug, set the <MAIN POWER> switch to <ON>, and press the power button <⏻/▶> on the control panel or on the remote control to turn on the power and start the projection.
- 2) Press the <MENU> button to display the main menu, then press ▲▼ to select [PROJECTOR SETUP].

- 3) Press the <ENTER> button.
- 4) Press ▲▼ to select [FILTER COUNTER].
- 5) Press the <ENTER> button.
  - The [FILTER COUNTER] screen is displayed.
- 6) Press ▲▼ to select [FILTER COUNTER RESET].
- 7) Press the <ENTER> button.
  - The [FILTER COUNTER RESET] screen is displayed.
- 8) Press ◀▶ to select [OK], then press the <ENTER> button.
  - The filter usage time is reset.

### Attention

---

---

- After washing the air filter unit, dry it thoroughly before attaching it back to the projector. Attaching a wet unit will cause an electric shock or malfunction.
- Do not disassemble the air filter unit.
- Make sure that the air filter unit is properly attached before using the projector. If it is not attached, the projector will suck in dirt and dust causing a malfunction.
- Do not put anything into the air vents. Doing so may result in malfunction of the projector.

### Note

---

---

- If you use the projector without attaching the air filter unit, the filter indicator <FILTER> blinks in red and the message appears on the projected image for approximately 30 seconds.
- Replace the air filter unit with the new optional Replacement Filter Unit (Model No.: ET-RFE300) if it is damaged or if the dirt does not come off even after washing.
- Air filter replacement is recommended after cleaning the unit two times.
- The dust-proof properties may be reduced after each cleaning.
- The replacement cycle of the air filter unit varies greatly depending on the usage environment.

## Replacing the unit

### Lamp unit

The lamp unit is a consumable component. Refer to “When to replace the lamp unit” (➔ page 142) for details about the replacement cycle.

When purchasing the optional Replacement Lamp Unit (Model No.: ET-LAEF100), consult your dealer.

It is recommended that you request a qualified technician to replace the lamp unit. Consult your dealer.

### WARNING

**Replace the lamp unit after the lamp has cooled (after waiting at least one hour).**

The high temperature inside the cover will cause burns.

### Notes on the replacement of the lamp unit

- Since the luminous lamp is made of glass, it may burst if dropped or hit with a hard object. Handle with care.
- Do not disassemble or modify the lamp unit.
- When replacing the lamp unit, be sure to hold it by the handle because its surface is pointed and its shape is protruded.
- The lamp may rupture. Replace the lamp unit carefully so that the glass fragments of the lamp do not scatter. While attaching the projector to the ceiling, do not work right under the lamp unit or do not conduct work while your face is near the lamp unit.
- The lamp contains mercury. When disposing of used lamp units, contact your local authorities or dealer for correct methods of disposal.

### Attention

- Panasonic takes no responsibility for any damage or malfunction of the product resulting from use of lamp units which are not manufactured by Panasonic. Use only specified lamp units.

### Note

- The model numbers of accessories and optional accessories are subject to change without prior notice.
- A Phillips screwdriver is necessary when replacing the lamp unit.

### When to replace the lamp unit

The lamp unit is a consumable component. Since its brightness gradually decreases over time, it is necessary to replace the lamp unit regularly.

Time for replacement

When [LAMP POWER] is constantly set to [NORMAL] without switching to other modes = 4 000 hours



When [LAMP POWER] is constantly set to [ECO] without switching to other modes = 5 000 hours

but the lamp may go off before the time above mentioned has elapsed depending on individual lamp characteristics, usage conditions, and the installation environment. It is recommended that the Replacement lamp unit be prepared earlier.

In order to predict the lamp replacement time, please refer to the lamp runtime displayed in [STATUS] (➔ page 93) → [RUNTIME] → [LAMP] → [NORMAL]/[ECO]. It also can be obtained by using the following formula. (The time which is displayed in [ECO] is the converted usage time when set to [NORMAL].)

**Formula for lamp replacement time (rough estimate) = “Lamp runtime of [NORMAL]” + “Lamp runtime of [ECO]” × 4/5**

If the time which is obtained by the above equation 4 000 hours has elapsed, the lamp turns off automatically after approximately 10 minutes, as it will cause malfunction of the projector.

	<b>On-screen display</b> 	<b>Lamp indicator</b>  <b>LAMP</b>
Over 3 800 hours	The message is displayed for 30 seconds. Pressing any button on the control panel or the remote control within 30 seconds will clear the message.	The indicator lights in red even during the standby mode.
Over 4 000 hours	The message remains displayed until you press any button.	

**Note**

- The time which is obtained by the formula for lamp replacement time “4 000 hours” is a rough guideline, but is not a guarantee. The lamp runtime differs depending on the setting of "LAMP POWER" menu.

**How to replace the lamp unit**

**Attention**

- While attaching the projector to the ceiling, do not work right under the lamp unit or do not conduct work while your face is near the lamp unit.
- Do not remove or loosen the screws other than specified ones when replacing the lamp unit.
- Make sure to attach the lamp unit and the lamp cover securely.

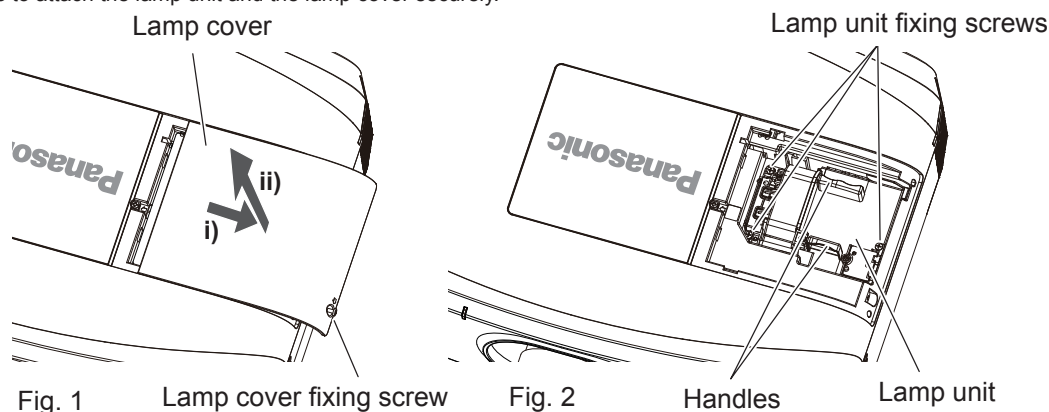

- 1) **Turn off the power of the projector and set the <MAIN POWER> switch to <OFF> and disconnect the power plug from the power outlet.**
  - Wait at least one hour and check if the lamp unit has cooled down.
- 2) **Remove the lamp cover. (Fig. 1)**
  - Use a Phillips screwdriver to turn the lamp cover fixing screw (x1) counterclockwise until it turns freely, and slide and pull up the lamp cover slowly in the direction of the arrow to remove it.
  - Opening the lamp cover quickly may result in falling.
- 3) **Remove the lamp unit. (Fig. 2)**
  - Use a Phillips screwdriver to turn the lamp unit fixing screws (x3) counterclockwise until they turn freely, and remove the lamp unit.
  - Hold the handles of the lamp unit and remove it straight.
- 4) **Push in the new lamp unit while paying attention to the insertion position.**
  - If the lamp unit is not installed properly, remove it and then push it in slowly. Pushing it in quickly or forcibly may break the connector.
- 5) **Use a Phillips screwdriver to firmly tighten the lamp unit fixing screws (x3).**
  - Make sure to attach the lamp unit securely.
- 6) **Attach the lamp cover.**
  - i) Perform Step 2) in the reverse order to attach the lamp cover.
  - ii) Use a Phillips screwdriver to firmly tighten the lamp cover fixing screw (x1).
    - Make sure to attach the lamp cover slowly and securely.

### Note

---

---

- When you replace the lamp unit with new one, the projector resets the runtime of the lamp unit automatically.

### Air filter unit

---

When the dust remains after cleaning, it is time to replace the air filter.

The Replacement Filter Unit (Model No.: ET-RFE300) is an optional accessory. To purchase the product, consult your dealer.

---

### How to replace the air filter unit

---

#### Attention

---

---

- Make sure that the projector is stable, and perform the replacement in a safe place where the unit will not be damaged even if you drop the air filter cover or the air filter unit.
- 1) **Turn off the power of the projector and set the <MAIN POWER> switch to <OFF> and disconnect the power plug from the power outlet.**
  - 2) **Remove the air filter unit.**
    - Refer to “Removing the air filter unit” (➡ page 139).
  - 3) **Attach the optional Replacement Filter Unit (Model No.: ET-RFE300) to the projector.**
    - Step 3) ~ Step 4), refer to “Attaching the air filter unit” (➡ page 140).
  - 4) **Attach the air filter cover to the projector.**
  - 5) **Execute the [FILTER COUNTER RESET].**
    - Refer to “Procedure of [FILTER COUNTER RESET]” (➡ page 140).

#### Attention

---

---

- When using the projector, be sure to attach the air filter unit. If it is not attached, the projector will suck in dirt and dust which may cause a malfunction. The air filter unit to replace the old one should be an unused product.

### Note

---

---

- If you use the projector without attaching the air filter unit, the message appears on the projected image for approximately 30 seconds.



# Troubleshooting

Review the following points. For details, see the corresponding pages.

Problems	Points to be checked	Page
<b>Power does not turn on.</b>	• Is the power plug firmly inserted into the outlet?	—
	• Is the <MAIN POWER> switch set to <OFF>?	51
	• Is the wall outlet supplying electricity?	—
	• Have the circuit breakers tripped?	—
	• Is the lamp indicator <LAMP> or the temperature indicator <TEMP> lit or blinking?	137
	• Is the lamp cover attached securely?	143
<b>No image appears.</b>	• Are connections to external devices correctly performed?	41
	• Is the input selection setting correct?	52
	• Is the [BRIGHTNESS] adjustment setting at a minimum?	67
	• Is the external device that is connected to the projector working properly?	—
	• Is the shutter function or the AV mute function in use?	55, 88
	• Is the lens cover still attached to the lens?	47
<b>Image is fuzzy.</b>	• Is the lens focus set correctly?	53
	• Is the projection distance appropriate?	32
	• Is the lens dirty?	21
	• Is the projector installed perpendicular to the screen?	—
<b>Color is pale or grayish.</b>	• Is [COLOR] or [TINT] adjusted correctly?	68
	• Is the external device connected to the projector adjusted correctly?	—
	• Is the RGB cable damaged?	—
<b>Audio is not output.</b>	• Is the external device connected correctly to the audio input terminal?	28
	• Is [MUTE] in [AUDIO SETTING] set to [ON]?	99
	• Is the audio input selection in [AUDIO SETTING] set correctly?	99
<b>Audio is not output from the built-in speaker.</b>	• Is [BUILT-IN SP] in [AUDIO SETTING] set to [OFF]?	98
	• Is the audio input selection in [AUDIO SETTING] set correctly?	99
<b>Remote control does not respond.</b>	• Are the batteries depleted?	—
	• Is the polarity of the batteries set correctly?	29
	• Are there any obstructions between the remote control and the remote control signal receiver of the projector?	26
	• Is the remote control being used beyond its effective operation range?	26
	• Are other forms of light, such as fluorescent light, affecting the projection?	26
	• Is the [REMOTE CONTROLLER] setting in [CONTROL DEVICE SETUP] set to [DISABLE]?	106
	• Is the ID number setting operation correct?	61
	• Is the <REMOTE 1 IN> terminal used for contact control?	155
	• Is the cable that is connected to the <REMOTE 2 IN> terminal connected to the remote control wired terminal?	29
<b>Menu screen does not appear.</b>	• Is the on-screen display function turned off (hidden)?	56
<b>Buttons on the control panel do not operate.</b>	• Is the [CONTROL PANEL] setting in [CONTROL DEVICE SETUP] set to [DISABLE]?	106
	• Is the <REMOTE 1 IN> terminal used for contact control?	155
<b>Image does not display correctly.</b>	• Is the [TV-SYSTEM], [RGB/YC <sub>B</sub> C <sub>R</sub> ]/[RGB/YP <sub>B</sub> P <sub>R</sub> ] selection set correctly?	71
	• Is there a problem with the video tape or other image sources?	—
	• Is a signal which is not compatible with the projector being input?	157
<b>Image from a computer does not appear.</b>	• Is the cable too long? (For D-Sub cables, the cable length should be 10 m (32'10") or shorter.)	—
	• Is the external video output on the laptop computer set correctly? (Ex.: The external output settings may be switched by pressing the "Fn" + "F3" or "Fn" + "F10" simultaneously. Since the method varies depending on the computer type, refer to the user manual provided with your computer.)	—

## Chapter 6 Maintenance — Troubleshooting

Problems	Points to be checked	Page
<b>Video from HDMI compatible device does not appear or it appears jumbled.</b>	• Is the HDMI cable connected securely?	41
	• Turn off and on the power of the projector and the external device.	—
	• Is a signal which is not compatible with the projector being input?	157
<b>Audio from HDMI compatible device does not appear.</b>	• Set to the linear PCM audio for the connected devices.	—
<b>The DIGITAL LINK input image or sound is not output.*1</b>	• Are the connections between the twisted-pair-cable transmitter and the projector or an external device correctly done?	—
	• Is [DIGITAL LINK MODE] set to [AUTO], [DIGITAL LINK] or [LONG REACH]?	108
	• Is a signal which is not compatible with a twisted-pair-cable transmitter being input?	—
<b>Lens shift cannot be adjusted.</b>	• Perform [LENS CALIBRATION].	103

\*1 Only for PT-EZ590, PT-EW650 and PT-EX620

### **Attention**

- If problems persist even after checking the preceding points, consult your dealer.

# Chapter 7 **Appendix**

---

This chapter describes specifications for the projector.

# Technical information

## PJLink protocol

The network function of this projector supports the PJLink class 1, and the PJLink protocol can be used to perform projector setting and projector status query operations from a computer.

### Control commands

The following table lists the PJLink protocol commands that can be used to control the projector.

• x characters in tables are non-specific characters.

Command	Control details	Parameter/return string	Remark	
POWR	Power supply control	0 1	Standby Power on	
POWR?	Power supply status query	0 1 2 3	Standby Power on Preparing for switching off the projector Warm-up	
INPT	Input selection	11 12 21	RGB1 RGB2 VIDEO	
INPT?	Input selection query	31 32 33 51	HDMI1 HDMI2 DIGITAL LINK *1 NETWORK	
AVMT	Shutter control *2,4 / AV mute control *3,4	30	Shutter function off (shutter open)/AV mute function off	
AVMT?	Shutter status query *2 / AV mute status query *3	31	Shutter function on (shutter closed)/AV mute function on	
ERST?	Error status query	xxxxxx	1st byte 2nd byte 3rd byte 4th byte 5th byte 6th byte	Indicates fan errors, and returns 0 - 2. Indicates lamp errors, and returns 0 - 2. Indicates temperature errors, and returns 0 - 2. Indicates cover open errors, and returns 0 or 2. Indicates filter errors, and returns 0 - 2. Indicates other errors, and returns 0 - 2.
LAMP?	Lamp status query	xxxxxx	1st digit (1 - 5 digits): Lamp runtime 2nd digit: 0 = Lamp off, 1 = Lamp on	
INST?	Input selection list query	(EZ590 / EW650 / EX620) 11 12 21 31 32 33 51 (EW550 / EX520) 11 12 21 31 32 51		
NAME?	Projector name query	xxxxx	Returns the name set in [PROJECTOR NAME] of [NETWORK].	
INF1?	Manufacturer name query	Panasonic	Returns manufacturer name.	
INF2?	Model name query	EZ590 EW650, EW550 EX620, EX520	Returns model name.	
INF0?	Other information queries	xxxxx	Returns information such as version number.	
CLSS?	Class information query	1	Returns class for PJLink.	

\*1 Only for PT-EZ590, PT-EW650 and PT-EX620

\*2 For PT-EZ590, PT-EW650 and PT-EX620

\*3 Only for PT-EW550 and PT-EX520

\*4 When the [PROJECTOR SETUP] menu → [ECO MANAGEMENT] → [SHUTTER DETECTION] or [AV MUTE DETECTION] is set to [ON], do not switch on/off in a short time.

## PJLink security authentication

The password used for PJLink is the same as that of the password set for web control.

When using the projector without security authentication, do not set a password for web control.

- For specifications related to PJLink, refer to the website of Japan Business Machine and Information System Industries Association.

URL <http://pjlink.jbmia.or.jp/english/>

## Control commands via LAN

### When web control administrator rights password is set (Protect mode)

#### Connecting

- Obtain the IP address and the port number (Initial set value = 1024) of the projector and request for a connection to the projector.

- You can obtain both the IP address and the port number from the menu screen of the projector.

<b>IP address</b>	Obtain from the main menu → [NETWORK] menu → [NETWORK STATUS]
<b>Port number</b>	Obtain from the main menu → [NETWORK] menu → [NETWORK CONTROL] → [COMMAND PORT]

- Check the response from the projector.

	Data section	Blank	Mode	Blank	Random number section	Termination symbol
<b>Command example</b>	"NTCONTROL" (ASCII string)	' '	'1'	' '	"zzzzzzzz" (ASCII code hex number)	(CR) 0x0d
<b>Data length</b>	9 bytes	1 byte	1 byte	1 byte	8 bytes	1 byte

- Mode: 1 = Protect mode

- Generate a 32-byte hash value from the following data using MD5 algorithm.

- "xxxxxx:yyyyy:zzzzzzzz"

<b>xxxxxx</b>	Administrator rights user name for the web control (default user name is "admin1")
<b>yyyyy</b>	Password of above administrator rights user (default password is "panasonic")
<b>zzzzzzzz</b>	8-byte random number obtained in Step 2)

#### Command transmission method

Transmit using the following command formats.

##### ■ Transmitted data

	Header			Data section	Termination symbol
<b>Command example</b>	Hash value (Refer to "Connecting" above)	'0'	'0'	Control command (ASCII string)	(CR) 0x0d
<b>Data length</b>	32 bytes	1 byte	1 byte	Undefined length	1 byte

##### ■ Received data

	Header		Data section	Termination symbol
<b>Command example</b>	'0'	'0'	Control command (ASCII string)	(CR) 0x0d
<b>Data length</b>	1 byte	1 byte	Undefined length	1 byte

## ■ Error response

	String	Details	Termination symbol
Message	"ERR1"	Undefined control command	(CR) 0x0d
	"ERR2"	Out of parameter range	
	"ERR3"	Busy state or no-acceptable period	
	"ERR4"	Timeout or no-acceptable period	
	"ERR5"	Wrong data length	
	"ERRA"	Password mismatch	
Data length	4 bytes	—	1 byte

## When web control administrator rights password is not set (Non-protect mode)

### Connecting

- 1) Obtain the IP address and the port number (Initial set value = 1024) of the projector and request for a connection to the projector.

- You can obtain both the IP address and the port number from the menu screen of the projector.

IP address	Obtain from the main menu → [NETWORK] menu → [NETWORK STATUS]
Port number	Obtain from the main menu → [NETWORK] menu → [NETWORK CONTROL] → [COMMAND PORT]

- 2) Check the response from the projector.

	Data section	Blank	Mode	Termination symbol
Command example	"NTCONTROL" (ASCII string)	' '	'0'	(CR) 0x0d
Data length	9 bytes	1 byte	1 byte	1 byte

- Mode: 0 = Non-protect mode

### Command transmission method

Transmit using the following command formats.

## ■ Transmitted data

	Header		Data section	Termination symbol
Command example	'0' 0x30	'0' 0x30	Control command (ASCII string)	(CR) 0x0d
Data length	1 byte	1 byte	Undefined length	1 byte

## ■ Received data

	Header		Data section	Termination symbol
Command example	'0' 0x30	'0' 0x30	Control command (ASCII string)	(CR) 0x0d
Data length	1 byte	1 byte	Undefined length	1 byte

## ■ Error response

	String	Details	Termination symbol
Message	"ERR1"	Undefined control command	(CR) 0x0d
	"ERR2"	Out of parameter range	
	"ERR3"	Busy state or no-acceptable period	
	"ERR4"	Timeout or no-acceptable period	
	"ERR5"	Wrong data length	
	"ERRA"	Password mismatch	
Data length	4 bytes	—	1 byte

## <SERIAL IN> terminal

The <SERIAL IN> terminal of the projector conforms with RS-232C so that the projector can be connected to and controlled from a computer.

### Connection

#### ● When connecting directly

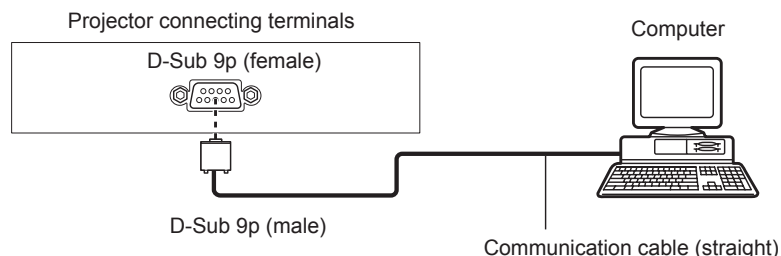

#### ● When connecting with DIGITAL LINK compatible devices

(Only for PT-EZ590, PT-EW650 and PT-EX620)

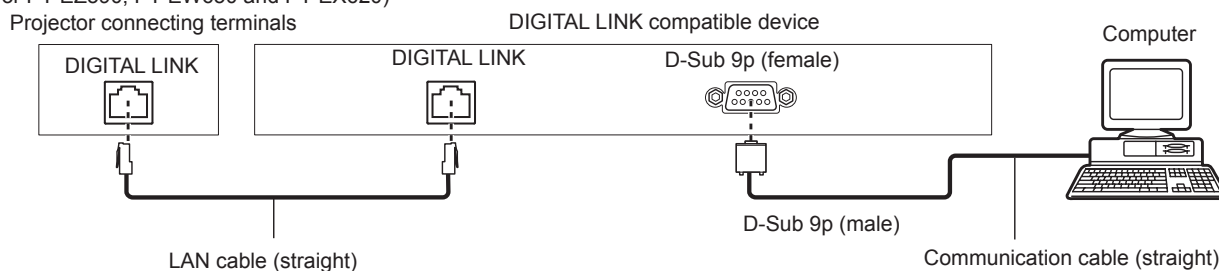

### Note

- The destination of [RS-232C] (➔ page 96) must be set according to the connection method.
- When connecting by a DIGITAL LINK compatible device, set the [PROJECTOR SETUP] menu → [ECO MANAGEMENT] → [STANDBY MODE] (➔ page 95) to [NORMAL] to control the projector in standby mode.  
When [STANDBY MODE] is set to [ECO], the projector cannot be controlled during standby.

### Pin assignments and signal names

D-Sub 9-pin (female) Outside view	Pin No.	Signal name	Details
	(1)	—	NC
	(2)	TXD	Transmitted data
	(3)	RXD	Received data
	(4)	—	NC
	(5)	GND	Earth
	(6)	—	NC
	(7)	CTS	Connected internally
	(8)	RTS	
	(9)	—	NC

### Communication conditions (Factory default)

Signal level	RS-232C-compliant
Sync. method	Asynchronous
Baud rate	9 600 bps
Parity	None
Character length	8 bits
Stop bit	1 bit
X parameter	None
S parameter	None



### Basic format

Transmission from the computer starts with STX, then the ID, command, parameter, and ETX are sent in this order. Add parameters according to the details of control.

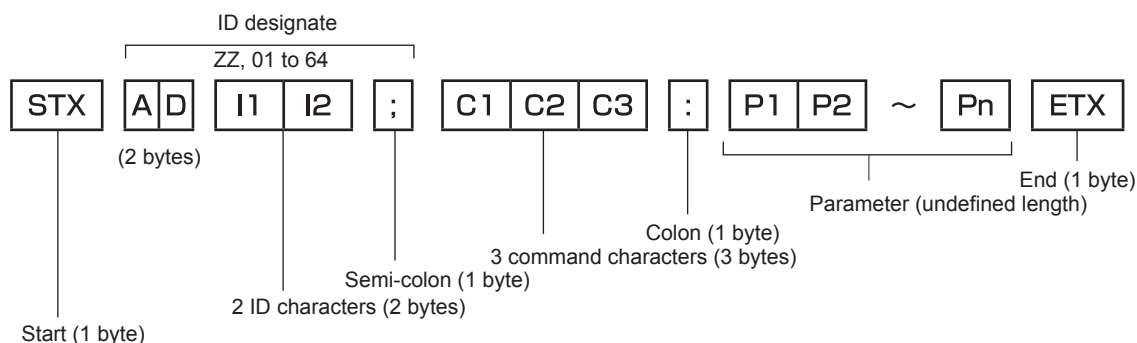

### Basic format (has subcommands)

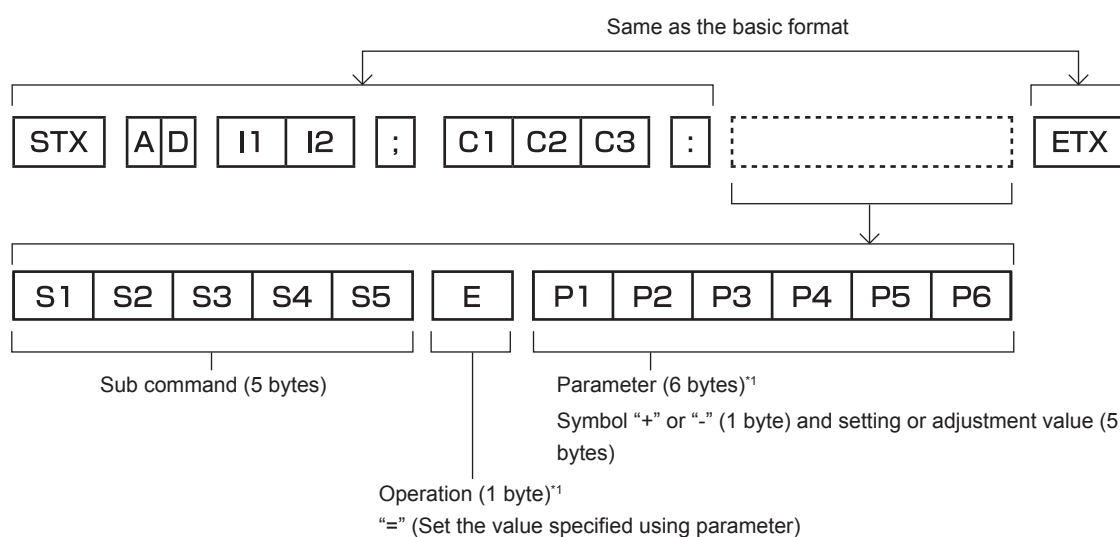

\*1 When transmitting a command which does not need a parameter, an operation (E) and parameter are not necessary.

### Attention

- If a command is transmitted after the lamp starts illuminating, there may be a delay in response or the command may not be executed. Try sending or receiving any command after 60 seconds.
- When transmitting multiple commands, be sure to wait until 0.5 seconds has elapsed after receiving the response from the projector before sending the next command. When transmitting a command which does not need a parameter, a colon (:) is not necessary.

### Note

- If a command cannot be executed, the "ER401" response is sent from the projector to the computer.
- If an invalid parameter is sent, the "ER402" response is sent from the projector to the computer.
- ID transmission in RS-232C supports ZZ (ALL) and 01 to 64.
- If a command is sent with a specified ID, a response will be sent to the computer only in the following cases.
  - It matches the projector ID
  - When [PROJECTOR ID] (➔ page 93) on the projector is [ALL]
- STX and ETX are character codes. STX shown in hexadecimal is 02, and ETX shown in hexadecimal is 03.

## Cable specification

When connected to a computer

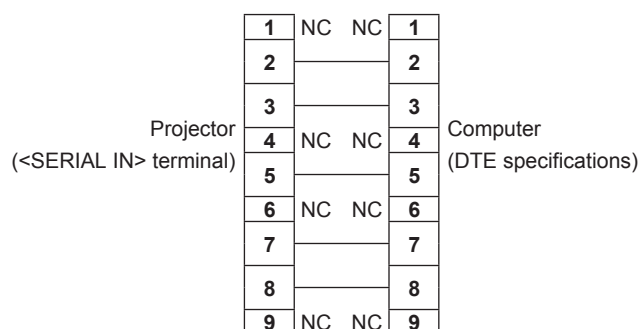

## Control command

The following table lists the commands that can be used to control the projector using a computer.

### ■ Projector control command

Command	Details	Parameter/response string	Remark (parameter)
PON	Power on	—	To check if the power is on, use the “Power query” command.
POF	Power standby		
QPW	Power query	000 001	STANDBY Power on
IIS	Switching the input signal	VID RG1 RG2 HD1 HD2 DL1 NWP	VIDEO RGB1 RGB2 HDMI1 HDMI2 DIGITAL LINK *1 NETWORK
Q\$L	Lamp cumulative runtime query	1	Returned with 0 to 99999
OSH	Shutter control *1/AV mute control *2	0	Shutter function off (shutter open)/AV mute function off
QSH	Shutter status query *1 / AV mute status query *2	1	Shutter function on (shutter closed)/AV mute function on
Q\$S	Lamp condition query	0 1 2 3	Stand-by Lamp ON control active Lamp ON Lamp OFF control active
VSE	Aspect ratio switch	0 1 2 5	AUTO NORMAL WIDE NATIVE
QS1	Aspect ratio settings query	6 9 10	FULL H FIT V FIT

\*1 Only for PT-EZ590, PT-EW650 and PT-EX620

\*2 Only for PT-EW550 and PT-EX520

### ■ Projector control command (with sub command)

Command	Sub command	Details	Remark
VXX	RYC11	RGB1 input setting	+00000=RGB/YP <sub>B</sub> P <sub>R</sub> , +00001=Y/C

■ Lens control command

Command	Sub command	Details	Remark
VXX	LNSI2	Lens H shift	+00000=Fine adjustment 1+, +00001=Fine adjustment 1-, +00100=Fine adjustment 2+, +00101=Fine adjustment 2-, +00200=Coarse adjustment+, +00201=Coarse adjustment-
VXX	LNSI3	Lens V shift	
VXX	LNSI4	Lens focus	
VXX	LNSI5	Lens zoom	

<REMOTE 1 IN> terminal

It is possible to control the projector remotely (by external contact) from a control panel located away from the projector where remote control signals cannot reach.

Use the <REMOTE 1 IN> terminal on the connecting terminals of the projector to connect to the control panel.

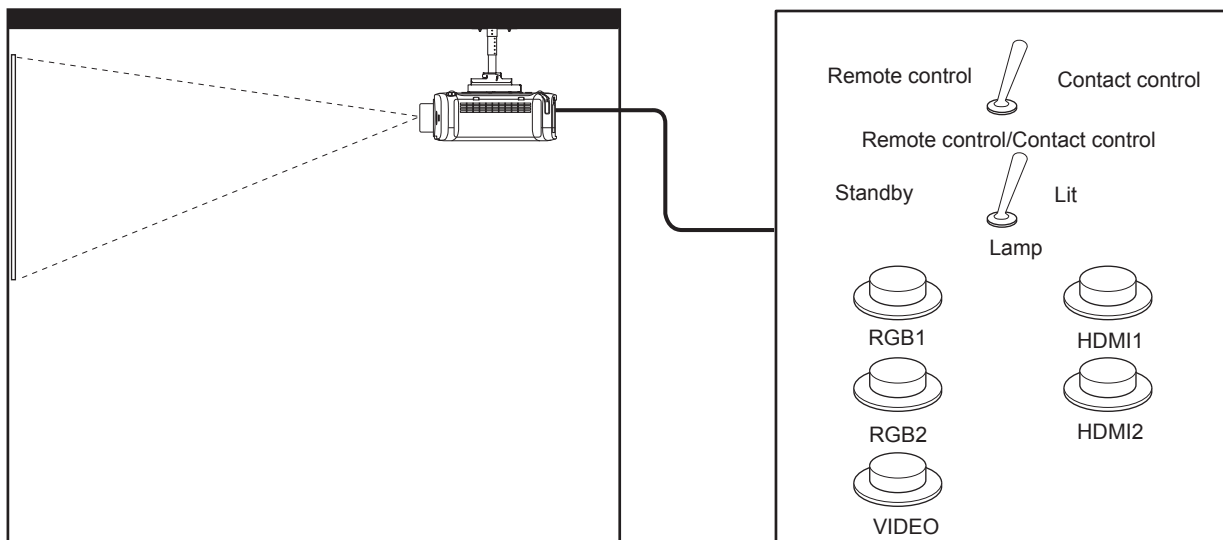

Installation locations in meeting rooms, etc.

Remote control board in another location

Pin assignments and signal names

D-Sub 9-pin Outside view	Pin No.	Signal name	Open (H)	Short (L)
	(1)	GND	—	GND
	(2)	POWER	OFF	ON
	(3)	RGB1	Other	RGB1
	(4)	RGB2	Other	RGB2
	(5)	VIDEO	Other	VIDEO
	(6)	HDMI1	Other	HDMI1
	(7)	HDMI2	Other	HDMI2
	(8)	SHUTTER *1	OFF	ON
	(9)	RST/SET	Controlled by remote control	Controlled by external contact

\*1 For PT-EZ590, PT-EW650 and PT-EX620  
[AV MUTE] for PT-EW550 and PT-EX520

Attention

- When controlling, make sure to short-circuit pins (1) and (9).
- When pins (1) and (9) are short-circuited, the following buttons on the control panel and the remote control are disabled. Commands for RS-232C and network functions corresponding to these functions are also disabled.
  - Power <⏻/> button, <HDMI1> button, <HDMI2> button, <DIGITAL LINK> button, <RGB1/2> button, <VIDEO> button, <SHUTTER> button, <AV MUTE> button and <INPUT SELECT> button

Note

- For pin (2) to pin (8) settings, you can make changes if you set [REMOTE1 MODE] to [USER]. (➡ page 97)

## **[MENU LOCK PASSWORD] operations**

---

To initialize your password, consult your distributor.

## List of compatible signals

The following table specifies the video signals compatible with the projector.

• Symbols that indicate formats are as follows.

- V: VIDEO, Y/C
- R: RGB
- Y: YC<sub>B</sub>C<sub>R</sub>/YP<sub>B</sub>P<sub>R</sub>
- H: HDMI/DIGITAL LINK

Mode	Display resolution (dots)	Scanning frequency		Dot clock frequency (MHz)	Format	Plug and play* <sup>1</sup>	
		Horizontal (kHz)	Vertical (Hz)			RGB2	HDMI/DIGITAL LINK
NTSC/NTSC4.43/ PAL-M/PAL60	720 x 480i	15.7	59.9	—	V	—	—
PAL/PAL-N/SECAM	720 x 576i	15.6	50.0	—	V	—	—
525 (480) /60i	712 x 483i	15.7	59.9	13.5	R/Y	—	—
625 (576) /50i	702 x 575i	15.6	50.0	13.5	R/Y	—	—
525 (480) /60i	720 (1 440) x 480i <sup>2</sup>	15.7	59.9	27.0	H	—	—
625 (576) /50i	720 (1 440) x 576i <sup>2</sup>	15.6	50.0	27.0	H	—	—
525 (480) /60p	720 x 480	31.5	59.9	27.0	R/Y/H	—	✓
625 (576) /50p	720 x 576	31.3	50.0	27.0	R/Y/H	—	✓
750 (720) /60p	1 280 x 720	45.0	60.0	74.3	R/Y/H	—	✓
750 (720) /50p	1 280 x 720	37.5	50.0	74.3	R/Y/H	—	✓
1125 (1080) /60i <sup>3</sup>	1 920 x 1 080i	33.8	60.0	74.3	R/Y/H	—	✓
1125 (1080) /50i	1 920 x 1 080i	28.1	50.0	74.3	R/Y/H	—	✓
1125 (1080) /24p	1 920 x 1 080	27.0	24.0	74.3	R/Y/H	—	✓
1125 (1080) /24sF	1 920 x 1 080i	27.0	48.0	74.3	R/Y/H	—	—
1125 (1080) /25p	1 920 x 1 080	28.1	25.0	74.3	R/Y/H	—	—
1125 (1080) /30p	1 920 x 1 080	33.8	30.0	74.3	R/Y/H	—	—
1125 (1080) /60p	1 920 x 1 080	67.5	60.0	148.5	R/Y/H	—	✓
1125 (1080) /50p	1 920 x 1 080	56.3	50.0	148.5	R/Y/H	—	✓
640 x 400	640 x 400	31.5	70.1	25.2	R/H	—	—
	640 x 400	37.9	85.1	31.5	R/H	—	—
640 x 480	640 x 480	31.5	59.9	25.2	R/H	✓	✓
	640 x 480	35.0	66.7	30.2	R/H	—	—
	640 x 480	37.9	72.8	31.5	R/H	✓	✓
	640 x 480	37.5	75.0	31.5	R/H	✓	✓
	640 x 480	43.3	85.0	36.0	R/H	—	—
800 x 600	800 x 600	35.2	56.3	36.0	R/H	✓	✓
	800 x 600	37.9	60.3	40.0	R/H	✓	✓
	800 x 600	48.1	72.2	50.0	R/H	✓	✓
	800 x 600	46.9	75.0	49.5	R/H	✓	✓
	800 x 600	53.7	85.1	56.3	R/H	—	—
832 x 624	832 x 624	49.7	74.6	57.3	R/H	✓	✓
1024 x 768	1 024 x 768	39.6	50.0	51.9	R/H	—	—
	1 024 x 768	48.4	60.0	65.0	R/H	—	—
	1 024 x 768	56.5	70.1	75.0	R/H	✓	✓
	1 024 x 768	60.0	75.0	78.8	R/H	✓	✓
	1 024 x 768	68.7	85.0	94.5	R/H	—	—
	1 024 x 768	81.4	100.0	113.3	R/H	—	—

## Chapter 7 Appendix — Technical information

Mode	Display resolution (dots)	Scanning frequency		Dot clock frequency (MHz)	Format	Plug and play*1	
		Horizontal (kHz)	Vertical (Hz)			RGB2	HDMI/DIGITAL LINK
1152 x 864	1 152 x 864	53.7	60.0	81.6	R/H	—	—
	1 152 x 864	67.5	75.0	108.0	R/H	—	—
	1 152 x 864	77.1	85.0	119.7	R/H	—	—
1152 x 870	1 152 x 870	68.7	75.1	100.0	R/H	✓	✓
1280 x 720	1 280 x 720	37.1	49.8	60.5	R/H	—	—
	1 280 x 720	44.8	59.9	74.5	R/H	—	—
1280 x 768	1 280 x 768	60.3	74.9	102.3	R/H	—	—
	1 280 x 768	68.6	84.8	117.5	R/H	—	—
1280 x 800	1 280 x 800	41.3	50.0	68.0	R/H	—	—
	1 280 x 800	49.7	59.8	83.5	R/H	✓*5	✓*5
	1 280 x 800	62.8	74.9	106.5	R/H	—	—
	1 280 x 800	71.6	84.9	122.5	R/H	—	—
1280 x 960	1 280 x 960	60.0	60.0	108.0	R/H	—	—
1280 x 1024	1 280 x 1 024	64.0	60.0	108.0	R/H	—	—
	1 280 x 1 024	80.0	75.0	135.0	R/H	—	—
	1 280 x 1 024	91.1	85.0	157.5	R/H	—	—
1366 x 768	1 366 x 768	39.6	49.9	69.0	R/H	—	—
	1 366 x 768	47.7	59.8	85.5	R/H	—	—
1400 x 1050	1 400 x 1 050	65.2	60.0	122.6	R/H	—	—
	1 400 x 1 050	65.3	60.0	121.8	R/H	—	—
	1 400 x 1 050	82.3	74.9	156.0	R/H	—	—
1440 x 900	1 440 x 900	55.9	59.9	106.5	R/H	—	—
1600 x 900	1 600 x 900	46.4	49.9	96.5	R/H	—	—
	1 600 x 900	55.9	60.0	119.0	R/H	—	—
1600 x 1200	1 600 x 1 200	75.0	60.0	162.0	R/H	✓	✓
1680 x 1050	1 680 x 1 050	54.1	50.0	119.5	R/H	—	—
	1 680 x 1 050	65.3	60.0	146.3	R/H	—	—
1920 x 1080	1 920 x 1 080	55.6	49.9	141.5	R/H	—	—
	1 920 x 1 080*4	66.6	59.9	138.5	R/H	—	—
1920 x 1200	1 920 x 1 200	61.8	49.9	158.3	R/H	—	—
	1 920 x 1 200*4	74.0	60.0	154.0	R/H	✓*6	✓*6

\*1 Signals with ✓ in the Plug and play columns are signals described in EDID (extended display identification data) of the projector. A signal, which has no ✓ in the Plug and play columns but has an entry in the Format column, can be input. For signals without ✓ in the Plug and play columns, resolution may not be selected in the computer even though the projector supports them.

\*2 Pixel-Repetition signal (dot clock frequency 27.0 MHz) only

\*3 When a 1125 (1035)/60i signal was input, it is displayed as a 1125 (1080)/60i signal. But 1125(1035)/60i HDMI signal is not supported.

\*4 VESA CVT-RB (Reduced Blanking)-compliant

\*5 Only for PT-EW650 and PT-EW550

\*6 Only for PT-EZ590

### Note

- The number of display dots for PT-EZ590 is 1 920 x 1 200. The number of display dots for PT-EW650 and PT-EW550 is 1 280 x 800. The number of display dots for PT-EX620 and PT-EX520 is 1 024 x 768. A signal with a different resolution is converted to the number of display dots.
- The "i" at the end of the resolution indicates an interlaced signal.
- When interlaced signals are connected, flickering may occur on the projected image.
- DIGITAL LINK input compatible signal is the same as HDMI input compatible signal.  
(Only for PT-EZ590, PT-EW650 and PT-EX620)
- When the communication method of the DIGITAL LINK is set to [LONG REACH], the signals that the projector can receive are up to 1080/60p(148.5MHz).  
(Only for PT-EZ590, PT-EW650 and PT-EX620)
- Even the above signals exist, some image signals that recorded in special method may not be displayed.

# Specifications

The specifications of the projector are as follows.

Power supply		PT-EZ590, PT-EZ590A, PT-EZ590D, PT-EW650, PT-EW650A, PT-EW650D, PT-EX620, PT-EX620A, PT-EX620D, PT-EW550, PT-EW550A, PT-EW550D, PT-EX520, PT-EX520A, PT-EX520D	100 V - 240 V $\sim$ (100 V - 240 V alternating current), 50 Hz/60 Hz
		PT-EZ590T, PT-EW650T, PT-EX620T, PT-EW550T, PT-EX520T	110 V $\sim$ (110 V alternating current), 60Hz
Power consumption	Projecting	PT-EZ590, PT-EZ590A, PT-EZ590D	484 W (5.5 A - 2.3 A)
		PT-EW650, PT-EW650A, PT-EW650D, PT-EX620, PT-EX620A, PT-EX620D, PT-EW550, PT-EW550A, PT-EW550D, PT-EX520, PT-EX520A, PT-EX520D	461 W (5.3 A - 2.1 A)
		PT-EZ590T	484 W (4.9 A)
		PT-EW650T, PT-EX620T, PT-EW550T, PT-EX520T	461 W (4.7 A)
	In standby mode	PT-EZ590, PT-EZ590A, PT-EZ590D, PT-EW650, PT-EW650A, PT-EW650D, PT-EX620, PT-EX620A, PT-EX620D, PT-EW550, PT-EW550A, PT-EW550D, PT-EX520, PT-EX520A, PT-EX520D	When [STANDBY MODE] of [ECO MANAGEMENT] is set to [ECO]: 0.5 W
		PT-EZ590T, PT-EW650T, PT-EX620T, PT-EW550T, PT-EX520T	When [STANDBY MODE] of [ECO MANAGEMENT] is set to [ECO]: 0.3 W
		PT-EZ590, PT-EW650, PT-EX620	When [STANDBY MODE] of [ECO MANAGEMENT] is set to [NORMAL]: 12 W When [STANDBY MODE] of [ECO MANAGEMENT] is set to [NORMAL], and [IN STANDBY MODE] in [AUDIO SETTING] is set to [ON]: 30 W
		PT-EW550, PT-EX520	When [STANDBY MODE] of [ECO MANAGEMENT] is set to [NORMAL]: 8 W When [STANDBY MODE] of [ECO MANAGEMENT] is set to [NORMAL], and [IN STANDBY MODE] in [AUDIO SETTING] is set to [ON]: 22 W
LCD panel	Size	PT-EZ590, PT-EW650, PT-EW550	1.63 cm (0.64") (aspect ratio 16:10)
		PT-EX620, PT-EX520	1.60 cm (0.63") (aspect ratio 4:3)
	Display system	Translucent screen LCD panel 3 panels, 3 primary color system	
	Drive system	Active matrix	
	Number of pixels	PT-EZ590	2 304 000 pixels (1 920 x 1 200 dots) x 3 panels
PT-EW650, PT-EW550		1 024 000 pixels (1 280 x 800 dots) x 3 panels	
PT-EX620, PT-EX520		786 432 pixels (1 024 x 768 dots) x 3 panels	
Lens <sup>*1</sup>	Electric zoom	PT-EZ590, PT-EW650, PT-EW550	1.22 ~ 2.26:1
		PT-EX620, PT-EX520	1.32 ~ 2.44:1
	Electric focus	F = 1.6 ~ 2.2 f = 17.1 mm ~ 31.7 mm	
Luminous lamp		320 W, UHM lamp	

## Chapter 7 Appendix — Specifications

<b>Light output</b> <sup>*2,3</sup>	<b>PT-EZ590</b>	5 400 lm	
	<b>PT-EW650</b>	5 800 lm	
	<b>PT-EW550</b>	5 000 lm	
	<b>PT-EX620</b>	6 200 lm	
	<b>PT-EX520</b>	5 300 lm	
<b>Contrast ratio</b> <sup>*3</sup>	<b>PT-EZ590, PT-EW650, PT-EX620</b>	10 000:1 (when [PICTURE MODE] is set to [DYNAMIC], [LAMP POWER] is set to [NORMAL], [IRIS] is set to [ON], [DAYLIGHT VIEW] is set to [OFF] and [AUTO POWER SAVE] is set to [OFF])	
	<b>PT-EW550, PT-EX520</b>	2 000:1 (when [PICTURE MODE] is set to [DYNAMIC], [LAMP POWER] is set to [NORMAL], [DAYLIGHT VIEW] is set to [OFF] and [AUTO POWER SAVE] is set to [OFF])	
<b>Color system</b>	7 standards (NTSC/NTSC4.43/PAL/PAL-N/PAL-M/SECAM/PAL60)		
<b>Projected image size</b>	1.02 m (40") - 10.16 m (400")		
<b>Screen aspect ratio</b>	<b>PT-EZ590, PT-EW650, PT-EW550</b>	16:10	
	<b>PT-EX620, PT-EX520</b>	4:3	
<b>Projection method</b>	[FRONT/CEILING], [FRONT/DESK], [REAR/CEILING], [REAR/DESK]		
<b>Speaker</b>	4.0 cm, round, x 1		
<b>Max. effective audio output</b>	10 W (monaural)		
<b>Power cord length</b>	2.0 m (78-3/4") (For Taiwan)		
	3.0 m (118-3/32") (For other countries)		
<b>Outer case</b>	Molded plastic		
<b>Dimensions</b>	<b>Width</b>	498 mm (19-19/32")	
	<b>Height</b>	145 mm (5-11/16") (with legs at shortest position)	
	<b>Depth</b>	<b>PT-EZ590, PT-EW650, PT-EW550, PT-EX620, PT-EX520</b>	398.3 mm (15-11/16") (including standard zoom lens)
		<b>PT-EZ590L, PT-EW650L, PT-EW550L, PT-EX620L, PT-EX520L</b>	358 mm (14-3/32") (excluding optional lens)
<b>Weight</b>	Approx. 8.4 kg (18.52 lbs.) <sup>*4</sup> (including standard zoom lens)		
	Approx. 7.7 kg (16.98 lbs.) <sup>*4</sup> (excluding optional lens)		
<b>Noise level</b> <sup>*3</sup>	35 dB when [LAMP POWER] is set to [NORMAL] 29 dB when [LAMP POWER] is set to [ECO]		
<b>Operating environment</b>	<b>Operating environment temperature</b> <sup>*5</sup>	0 °C (32 °F) - 45 °C (113 °F) (Elevation: below 1 400 m (4 593')) 0 °C (32 °F) - 40 °C (104 °F) (Elevation: 1 400 m (4 593') ~ 2 700 m (8 858'))	
	<b>Operating environment humidity</b>	20 % - 80 % (No condensation)	
<b>Remote control</b>	<b>Power supply</b>	DC 3 V (AAA/R03/LR03 battery x 2)	
	<b>Operating range</b>	Within approx. 30 m (98'5") (when operated directly in front of signal receiver)	
	<b>Weight</b>	102 g (3.6 ozs.) (including batteries)	
	<b>Dimensions</b>	Width: 48 mm (1-7/8"), Height: 145 mm (5-23/32"), Depth: 27 mm (1-1/16")	

\*1 For PT-EZ590L, PT-EW650L, PT-EX620L, PT-EW550L, PT-EX520L, the lens is sold separately.

\*2 Value is for the supplied standard zoom lens. The value varies depending on the lens.

\*3 Measurement, measuring conditions and method of notation all comply with ISO/IEC 21118:2012 international standards.

\*4 Average value. Weight varies for each product.

\*5 If the [PROJECTOR SETUP] menu → [LAMP POWER] is set to [NORMAL], [LAMP POWER] changes to [ECO] forcibly to protect the projector when the operating environment temperature becomes 40 °C (104 °F) or higher (35 °C (95 °F) or higher when using the projector at high altitudes).

### Note

- The model numbers of accessories and optional accessories are subject to change without prior notice.



■ Terminal

<b>&lt;RGB 1 IN&gt; terminal</b>	1 set, (BNC x 5 (RGB/YP <sub>B</sub> P <sub>R</sub> /YC <sub>B</sub> C <sub>R</sub> x 1)) <b>RGB signal</b> 0.7 V [p-p] 75 Ω (SYNC ON GREEN: 1.0 V [p-p] 75 Ω) SYNC/HD TTL high impedance, automatic positive/negative polarity compatible VD TTL high impedance, automatic positive/negative polarity compatible <b>YP<sub>B</sub>P<sub>R</sub> signal</b> Y: 1.0 V [p-p] including synchronization signal, P <sub>B</sub> P <sub>R</sub> : 0.7 V [p-p] 75 Ω <b>Y/C signal</b> Y: 1.0 V [p-p], C: 0.286 V [p-p] 75 Ω
<b>&lt;RGB 2 IN&gt; terminal</b>	1 set high-density D-Sub 15 p (female) <b>RGB signal</b> 0.7 V [p-p] 75 Ω (SYNC ON GREEN: 1.0 V [p-p] 75 Ω) SYNC/HD TTL high impedance, automatic positive/negative polarity compatible VD TTL high impedance, automatic positive/negative polarity compatible (The SYNC/HD and VD terminals do not support 3 value SYNC.) <b>YP<sub>B</sub>P<sub>R</sub> signal</b> Y: 1.0 V [p-p] including synchronization signal, P <sub>B</sub> P <sub>R</sub> : 0.7 V [p-p] 75 Ω
<b>&lt;MONITOR OUT&gt; terminal</b>	1 set, high-density D-Sub 15 p (female) <b>RGB signal</b> 0.7 V [p-p] 75 Ω (SYNC ON GREEN: 1.0 V [p-p] 75 Ω) SYNC/HD TTL high impedance, positive/negative polarity VD TTL high impedance, positive/negative polarity <b>YP<sub>B</sub>P<sub>R</sub> signal</b> Y: 1.0 V [p-p] including synchronization signal, P <sub>B</sub> P <sub>R</sub> : 0.7 V [p-p] 75 Ω
<b>&lt;VIDEO IN&gt; terminal</b>	1 set, pin jack 1.0 V [p-p] 75 Ω
<b>&lt;HDMI 1 IN&gt;/&lt;HDMI 2 IN&gt; terminal</b>	2 sets, HDMI 19 pin, HDCP compatible, Deep Color compatible <b>Audio signal</b> Linear PCM (Sampling frequency: 48 kHz/44.1 kHz/32 kHz)
<b>&lt;AUDIO IN 1&gt;/&lt;AUDIO IN 2&gt; terminal</b>	2 sets, M3 stereo mini jack 0.5 V [rms], input impedance 22 kΩ or more
<b>&lt;AUDIO IN 3&gt; terminal</b>	1 set, pin jack x 2 (L-R) 0.5 V [rms], input impedance 22 kΩ or more
<b>&lt;VARIABLE AUDIO OUT&gt; terminal</b>	1 set, M3 stereo mini jack (monitor output, stereo compatible) 0 V [rms] to 2.0 V [rms] (variable), output impedance 2.2 kΩ or less
<b>&lt;SERIAL IN&gt; terminal</b>	1 set, D-Sub 9 p, RS-232C compliant, for computer control
<b>&lt;REMOTE 1 IN&gt; terminal</b>	1 set, D-Sub 9 p, for external control
<b>&lt;REMOTE 2 IN&gt; terminal</b>	1 set, M3 stereo mini jack, for remote control (wired)
<b>&lt;DIGITAL LINK/LAN&gt; terminal *1</b>	1 set, RJ-45, for network, DIGITAL LINK connection, PLink compatible, 100Base-TX
<b>&lt;LAN&gt; terminal</b>	1 set, RJ-45, for network connection, PLink compatible, 10Base-T/100Base-TX
<b>&lt;WIRELESS&gt; terminal</b>	USB connector (type A) x 1, for the Wireless module (Model No.: ET-WML100) only
<b>&lt;DC OUT&gt; terminal</b>	USB connector (type A) x 1, for power supply only (DC 5 V, maximum 900 mA)

\*1 Only for PT-EZ590, PT-EW650 and PT-EX620

■ Applicable scanning frequency

Refer to “List of compatible signals” (➔ page 157) for the types of video signals that can be used with the projector.

<b>For video signal</b>	Horizontal : 15.73 kHz Vertical : 59.94 Hz, Horizontal : 15.63 kHz Vertical : 50 Hz
<b>For Y/C signal</b>	Horizontal : 15.73 kHz Vertical : 59.94 Hz, Horizontal : 15.63 kHz Vertical : 50 Hz
<b>For RGB signal</b>	<ul style="list-style-type: none"> <li>• Displayable resolution: 640 x 400 to 1 920 x 1 200</li> <li>• Dot clock frequency: 162 MHz or less</li> </ul>
<b>For YC<sub>B</sub>C<sub>R</sub>/YP<sub>B</sub>P<sub>R</sub> signal</b>	<ul style="list-style-type: none"> <li>• Displayable resolution: 480i/576i to 1 920 x 1 080</li> <li>• Dot clock frequency: 148.5 MHz or less</li> <li>• The SYNC/HD and VD terminals do not support 3 value SYNC.</li> </ul>
<b>For HDMI signal</b>	<ul style="list-style-type: none"> <li>• Displayable resolution for movie-based signals: 480i/576i*1 to 1 920 x 1 080</li> <li>• Displayable resolution for still image signals: 640 x 400 to 1 920 x 1 200 (non-interlaced)</li> <li>• Dot clock frequency: 25 MHz - 162 MHz</li> </ul>

\*1 Pixel-Repetition signal (dot clock frequency 27.0 MHz) only

**Note**

- DIGITAL LINK input compatible signal is the same as HDMI input compatible signal. (Only for PT-EZ590, PT-EW650 and PT-EX620)

# Dimensions

Unit: mm

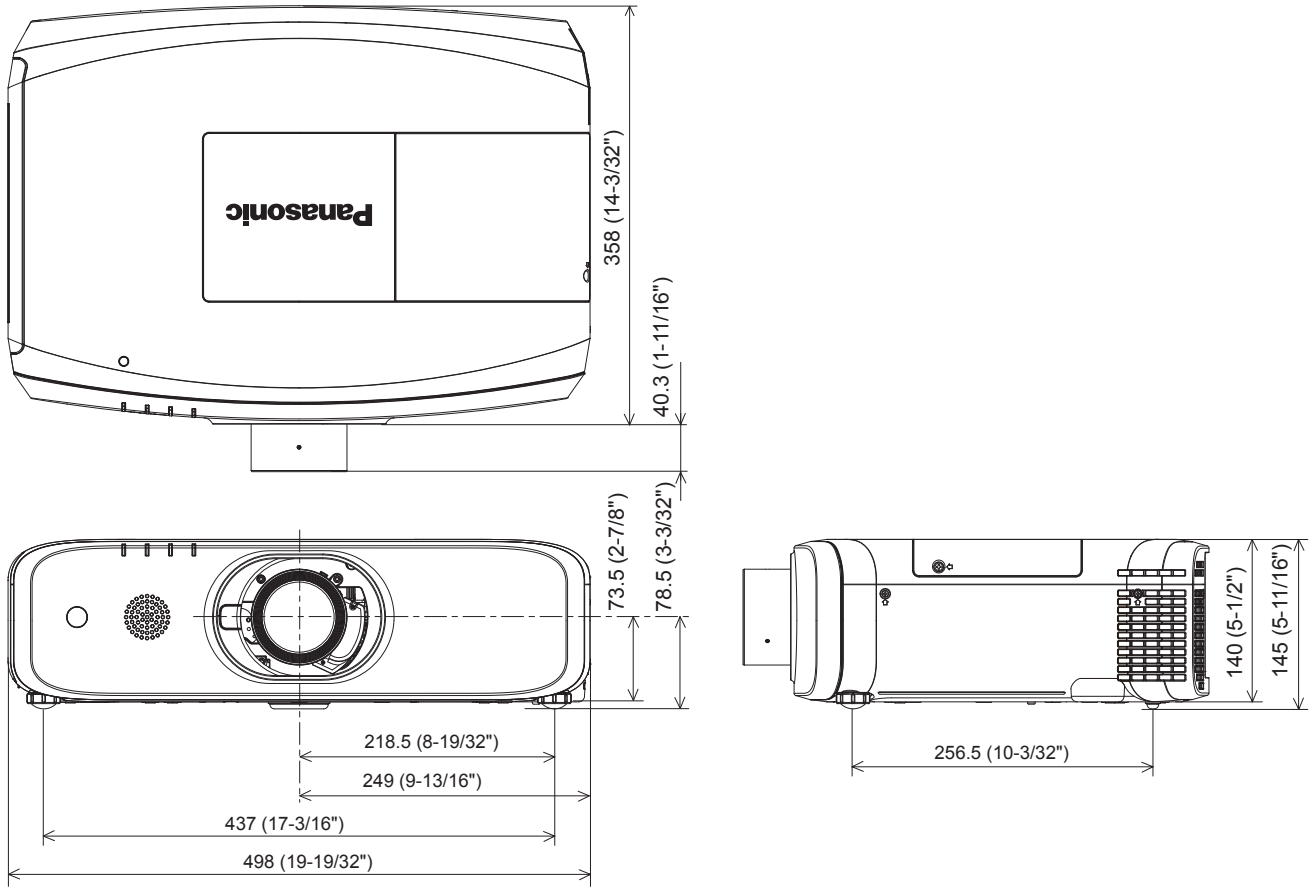

\* The above dimensions are obtained when the standard zoom lens is attached.

\* Actual dimensions may differ depending on the product.

# Precautions for Attaching Ceiling Mount Bracket

- When installing the projector to a ceiling, be sure to use the specified optional Ceiling Mount Bracket as the following combinations:
  - ① ET-PKD120H (for High Ceilings) and ET-PKE301B (Projector Mount Bracket)
  - ② ET-PKD120S (for Low Ceilings) and ET-PKE301B (Projector Mount Bracket)
 Other combination is not available.
- When installing the projector, attach the drop-prevention wire supplied with the Projector Mount Bracket.
- Ask a qualified technician to do the installation work such as mounting the projector on the ceiling.
- Panasonic takes no responsibility for any accident, damage, damages to the projector resulting from use of a ceiling mount bracket not manufactured by Panasonic, optional Ceiling Mount Bracket combinations not specified, installation method not described in installation manual, optional accessories not specified or the inappropriate choice of location for installation, even if the warranty period of the projector has not expired.
- Unused products must be removed promptly by a qualified technician.
- Use a torque screwdriver or Allen torque wrench to tighten bolts to their specified tightening torques. Do not use electric screwdrivers or impact screwdrivers.
- Read the Installation Instructions for the Ceiling Mount Bracket for details.
- The model numbers of accessories and optional accessories are subject to change without prior notice.

Bottom view

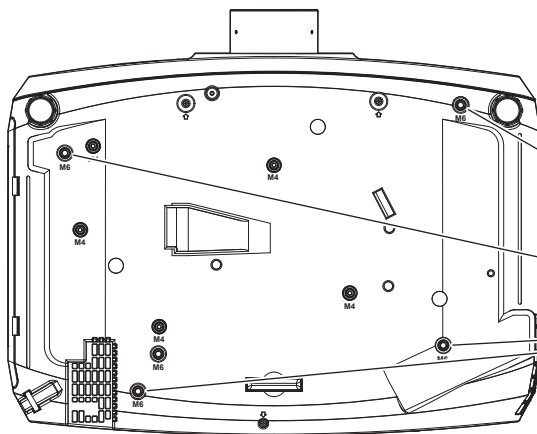

Model No. of Ceiling Mount Bracket:

- ① ET-PKD120H (for High Ceilings)  
ET-PKE301B (Projector Mount Bracket)
- ② ET-PKD120S (for Low Ceilings)  
ET-PKE301B (Projector Mount Bracket)

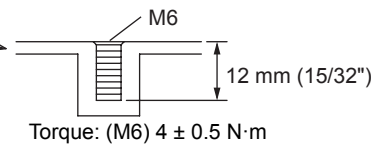

## Note

- You can also use the existing ceiling mount bracket ET-PKF110H (for High Ceilings) or ET-PKF110S (for Low Ceilings).  
 Model No. of Ceiling Mount Bracket (Supplement):
  - ③ ET-PKF110H (for High Ceilings)
  - ④ ET-PKF110S (for Low Ceilings)

Bottom view

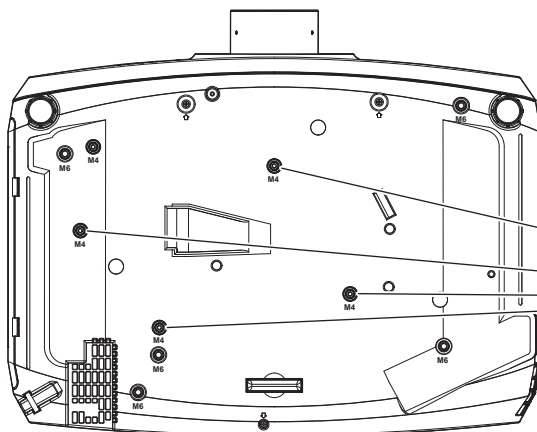

Model No. of Ceiling Mount Bracket:

- ③ ET-PKF110H (for High Ceilings)
- ④ ET-PKF110S (for Low Ceilings)

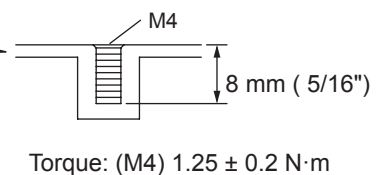

## Index

- A**
- About Presenter Light . . . . . 117
  - About VueMagic . . . . . 119
  - Accessories . . . . . 23
  - <AC IN> terminal . . . . . 26, 46
  - Adjusting adjustable feet . . . . . 38
  - Adjusting the volume . . . . . 56
  - [ADVANCED MENU] . . . . . 69
  - Air filter unit . . . . . 139
  - [ASPECT] . . . . . 79
  - <ASPECT> button
    - Remote control . . . . . 25, 58
  - <AUTO SETUP> button
    - Remote control . . . . . 25, 57
  - [AUTO SETUP SETTING] . . . . . 89
  - <AV MUTE> button
    - Projector body . . . . . 27
    - Remote control . . . . . 25, 55
- B**
- [BACK COLOR] . . . . . 90
  - [BRIGHTNESS] . . . . . 67
- C**
- Cautions on use . . . . . 21
  - Cautions when installing . . . . . 17
  - Cautions when transporting . . . . . 17
  - CD-ROM . . . . . 24
  - [CLAMP POSITION] . . . . . 80
  - [CLOCK PHASE] . . . . . 79
  - [CLOSED CAPTION SETTING] . . . . . 86
  - [COLOR] . . . . . 68
  - [COLOR TEMPERATURE] . . . . . 68
  - Connecting the remote control to the projector
    - with a cable . . . . . 29
  - Connection . . . . . 41
  - [CONTRAST] . . . . . 67
  - [CONTROL DEVICE SETUP] . . . . . 106
  - Crestron Connected . . . . . 133
- D**
- [DATE AND TIME] . . . . . 103
  - [DAYLIGHT VIEW] . . . . . 70
  - <DEFAULT> button
    - Remote control . . . . . 25, 64
  - [DIGITAL CINEMA REALITY] . . . . . 70
  - DIGITAL LINK . . . . . 19
  - <DIGITAL LINK> button
    - Remote control . . . . . 25, 52
  - [DIGITAL LINK IN] . . . . . 85
  - [DIGITAL LINK MENU] . . . . . 109
  - [DIGITAL LINK MODE] . . . . . 108
  - [DIGITAL LINK STATUS] . . . . . 108
  - Dimensions . . . . . 162
  - Display language . . . . . 81
  - [DISPLAY OPTION] . . . . . 82
  - [DISPLAY SETTING] . . . . . 105
  - Disposal . . . . . 22
  - [DOT CLOCK] . . . . . 78
  - <D.ZOOM> button
    - Remote control . . . . . 25, 58
- E**
- Early Warning Software . . . . . 21
  - <ECO> button
    - Remote control . . . . . 25, 60
  - [ECO MANAGEMENT] . . . . . 94
  - <ENTER> button
    - Projector body . . . . . 27
    - Remote control . . . . . 25
- F**
- [FILTER COUNTER] . . . . . 100
  - Filter indicator . . . . . 137
  - <FOCUS> button
    - Remote control . . . . . 25, 53
  - [FRAME LOCK] . . . . . 80
  - <FREEZE> button
    - Remote control . . . . . 25, 56
  - <FUNCTION> button
    - Remote control . . . . . 25, 59
  - [FUNCTION BUTTON] . . . . . 97
- G**
- [GAMMA] . . . . . 69
- H**
- <HDMI1> button
    - Remote control . . . . . 25, 52
  - <HDMI2> button
    - Remote control . . . . . 25, 52
  - [HDMI IN] . . . . . 84
- I**
- <ID ALL> button
    - Remote control . . . . . 25, 61
  - <ID SET> button
    - Remote control . . . . . 25, 61
  - [INITIALIZE] . . . . . 111
  - [INITIALIZE ALL] . . . . . 104
  - Initial setting . . . . . 48
  - [INITIAL START UP] . . . . . 93
  - <INPUT SELECT> button
    - Projector body . . . . . 27, 52
    - Installation mode . . . . . 31
- L**
- Lamp cover . . . . . 27
  - Lamp indicator . . . . . 137
  - [LAMP POWER] . . . . . 94
  - <LENS> button
    - Projector body . . . . . 27, 53
    - [LENS CALIBRATION] . . . . . 103
  - List of compatible signals . . . . . 157
- M**
- Main menu . . . . . 64
  - Main power switch . . . . . 26, 47
  - Maintenance/replacement . . . . . 139
  - <MENU> button
    - Projector body . . . . . 27, 63
    - Remote control . . . . . 25
  - Menu item . . . . . 64
  - [MENU LOCK] . . . . . 106
  - [MENU LOCK PASSWORD] . . . . . 106
  - <MUTE> button
    - Remote control . . . . . 25, 56
- N**
- Navigating through the menu . . . . . 63
  - [NETWORK] . . . . . 66, 108
  - <NETWORK> button
    - Remote control . . . . . 25, 52
  - Network connections . . . . . 113
  - [NETWORK CONTROL] . . . . . 110
  - [NETWORK STATUS] . . . . . 110
  - [NOISE REDUCTION] . . . . . 70
- O**
- <ON SCREEN> button
    - Remote control . . . . . 25, 56
  - [ON-SCREEN DISPLAY] . . . . . 82
  - On-screen menu . . . . . 63
  - Optional accessories . . . . . 24
  - [OTHER FUNCTIONS] . . . . . 91
  - [OVER SCAN] . . . . . 79
- P**
- [PASSWORD] . . . . . 105
  - [PASSWORD CHANGE] . . . . . 105
  - [PICTURE] . . . . . 67
  - [PICTURE MODE] . . . . . 67
  - PJLink protocol . . . . . 148
  - [POSITION] . . . . . 72
  - Power button
    - Projector body . . . . . 27
    - Remote control . . . . . 25
  - Power cord . . . . . 46
  - Power indicator . . . . . 46
  - Precautions for attaching Ceiling Mount Bracket 163
  - Precautions for use . . . . . 17
  - Projecting . . . . . 52
  - [PROJECTION METHOD] . . . . . 94
  - Projector body . . . . . 26
  - [PROJECTOR ID] . . . . . 93
- [PROJECTOR NAME] . . . . . 109
- [PROJECTOR SETUP] . . . . . 66, 93
- [P-TIMER] . . . . . 90
- <P-TIMER> button
  - Remote control . . . . . 25, 59
- R**
- Read this first! . . . . . 4
  - [REALTIME KEYSTONE] . . . . . 72
  - <REMOTE 1 IN> terminal . . . . . 155
  - [REMOTE1 MODE] . . . . . 97
  - <REMOTE 2 IN> terminal . . . . . 29
  - Remote control . . . . . 25
  - Remote control operations . . . . . 55
  - Removing/attaching the Projection Lens . . . . . 39
  - Replacing the air filter unit . . . . . 144
  - Replacing the lamp unit . . . . . 142
  - Replacing the unit . . . . . 142
  - Resetting adjustment values to the factory
    - default . . . . . 64
  - <RGB1/2> button
    - Remote control . . . . . 25, 52
  - [RGB IN] . . . . . 83
  - [RGB/Y<sub>P</sub>B<sub>P</sub>R] / [RGB/Y<sub>C</sub>B<sub>C</sub>R] . . . . . 71
  - [RS-232C] . . . . . 66, 96
- S**
- [SCHEDULE] . . . . . 101
  - <SCREEN ADJ> button
    - Remote control . . . . . 25, 57
  - [SCREEN ADJUSTMENT] . . . . . 72, 76
  - [SCREEN SETTING] . . . . . 87
  - Security . . . . . 19
  - [SECURITY] . . . . . 66, 105
  - Selecting the input signal . . . . . 52
  - <SERIAL IN> terminal . . . . . 152
  - [SERVICE PASSWORD] . . . . . 104
  - Setting up . . . . . 31
  - [SHARPNESS] . . . . . 68
  - [SHIFT] . . . . . 78
  - <SHIFT> button
    - Remote control . . . . . 25, 53
  - <SHUTTER> button
    - Projector body . . . . . 27
    - Remote control . . . . . 25, 55
  - [SHUTTER SETTING] . . . . . 88
  - [SIGNAL SEARCH] . . . . . 89
  - Specifications . . . . . 159
  - [STARTUP INPUT SELECT] . . . . . 89
  - [STARTUP LOGO] . . . . . 88
  - [STATUS] . . . . . 93
  - <STATUS> button
    - Remote control . . . . . 25, 60
  - Storage . . . . . 22
  - Sub-menu . . . . . 64
  - Switching off the projector . . . . . 51
  - Switching on the projector . . . . . 47
  - [SXGA MODE] . . . . . 90
- T**
- Temperature indicator . . . . . 137
  - [TEST PATTERN] . . . . . 100
  - <TEST PATTERN> button
    - Remote control . . . . . 25, 59
  - [TEXT CHANGE] . . . . . 106
  - [TINT] . . . . . 68
  - Troubleshooting . . . . . 145
  - [TV-SYSTEM] . . . . . 71
- V**
- <VIDEO> button
    - Remote control . . . . . 25, 52
  - <VOL->/<VOL+> button
    - Projector body . . . . . 27
    - Remote control . . . . . 25, 56
- W**
- [WIDE MODE] . . . . . 90
  - [WIRED LAN] . . . . . 109
- Z**
- <ZOOM> button
    - Remote control . . . . . 25, 53

## Disposal of Old Equipment and Batteries Only for European Union and countries with recycling systems



These symbols on the products, packaging, and/or accompanying documents mean that used electrical and electronic products and batteries must not be mixed with general household waste. For proper treatment, recovery and recycling of old products and used batteries, please take them to applicable collection points in accordance with your national legislation. By disposing of them correctly, you will help to save valuable resources and prevent any potential negative effects on human health and the environment.

For more information about collection and recycling, please contact your local municipality. Penalties may be applicable for incorrect disposal of this waste, in accordance with national legislation.



### Note for the battery symbol (bottom symbol)

This symbol might be used in combination with a chemical symbol. In this case it complies with the requirement set by the Directive for the chemical involved.

### Information on Disposal in other Countries outside the European Union

These symbols are only valid in the European Union.

If you wish to discard these items, please contact your local authorities or dealer and ask for the correct method of disposal.

### Product Information (for Turkey only)

AEEE Yönetmeliğine Uygundur.

Eski Ekipman ve Bataryaların İşlenmesi.

Sadece geri dönüşüm sistemleri olan Avrupa Birliği ve ülkeleri için geçerlidir.



Ürünler, ambalaj ve/veya ekli belgeler üzerindeki bu semboller kullanılmış elektrik ve elektronik ürünlerin ve pillerin genel ev atığı ile karıştırılmaması gerektiğini ifade eder.

Eski ürünlerin ve pillerin toplanması ve geri kazanılması için bu atıkları lütfen yasayla belirlenmiş olan uygun toplama merkezlerine teslim ediniz.

Bu atıkların doğru işlenmesiyle, değerli kaynakların korunmasına ve insan sağlığı ve çevreye olası negatif etkilerinin engellenmesine yardımcı olabilirsiniz.

Atıkların toplanması ve geri dönüşümü için detaylı bilgi için lütfen bağlı olduğunuz yerel yönetimlerle iletişime geçiniz.

Atıkların atılmasıyla ilgili yanlış uygulamalar yasayla belirlenmiş olan cezalara sebebiyet verebilir.

# Panasonic Corporation

Web Site: <https://panasonic.net/cns/projector/>

© Panasonic Corporation 2016

## Panasonic System Solutions Company of North America

Two Riverfront Plaza, Newark, NJ 07102

TEL: (877) 803 - 8492

## Panasonic Canada Inc.

5770 Ambler Drive, Mississauga, Ontario L4W 2T3

TEL: (905) 624 - 5010

W0316JG6069 -PT